

MERCUSYS[®]

User Guide

AC1200 Wireless Dual Band Gigabit Router

MR30G

REV1.0.0
1910080062

COPYRIGHT & TRADEMARK

Specifications are subject to change without notice. **MERCUSYS**[®] is a registered trademark of MERCUSYS TECHNOLOGIES CO., LTD. Other brands and product names are trademarks or registered trademarks of their respective holders.

No part of the specifications may be reproduced in any form or by any means or used to make any derivative such as translation, transformation, or adaptation without permission from MERCUSYS TECHNOLOGIES CO., LIMITED. Copyright © 2021 MERCUSYS TECHNOLOGIES CO., LIMITED. All rights reserved.

<http://www.mercusys.com>

CE Mark Warning



This is a class B product. In a domestic environment, this product may cause radio interference, in which case the user may be required to take adequate measures.

OPERATING FREQUENCY (the maximum transmitted power)

2400 MHz -2483.5 MHz (20 dBm)

5150 MHz -5250 MHz (23 dBm)

EU declaration of conformity

Mercusys hereby declares that the device is in compliance with the essential requirements and other relevant provisions of directives 2014/53/EU, 2009/125/EC, 2011/65/EU and (EU)2015/863.

The original EU Declaration of Conformity may be found at <http://www.mercusys.com/en/ce>

RF Exposure Information

This device meets the EU requirements (2014/53/EU Article 3.1a) on the limitation of exposure of the general public to electromagnetic fields by way of health protection.

The device complies with RF specifications when the device used at 20 cm from your body.

National restrictions

Attention: This device may only be used indoors in all EU member states, EFTA countries and Northern Ireland.

Attention: This device may only be used indoors in Great Britain.

	AT	BE	BG	CH	CY	CZ	DE	DK
	EE	EL	ES	FI	FR	HR	HU	IE
	IS	IT	LI	LT	LU	LV	MT	NL
	NO	PL	PT	RO	SE	SI	SK	UK(NI)

	UK
--	----

UK Declaration of Conformity

Mercusys hereby declares that the device is in compliance with the essential requirements and other relevant provisions of the Radio Equipment Regulations 2017.

The original UK Declaration of Conformity may be found at <https://www.mercusys.com/support/ukca/>



NCC Notice

注意！

取得審驗證明之低功率射頻器材，非經核准，公司、商號或使用者均不得擅自變更頻率、加大功率或變更原設計之特性及功能。

低功率射頻器材之使用不得影響飛航安全及干擾合法通信；經發現有干擾現象時，應立即停用，並改善至無干擾時方得繼續使用。

前述合法通信，指依電信管理法規定作業之無線電通信。

低功率射頻器材須忍受合法通信或工業、科學及醫療用電波輻射性電機設備之干擾。

應避免影響附近雷達系統之操作。

高增益指向性天線只得應用於固定式點對點系統。

BSMI Notice

安全諮詢及注意事項

- 請使用原裝電源供應器或只能按照本產品注明的電源類型使用本產品。
- 清潔本產品之前請先拔掉電源線。請勿使用液體、噴霧清潔劑或濕布進行清潔。
- 注意防潮，請勿將水或其他液體潑灑到本產品上。
- 插槽與開口供通風使用，以確保本產品的操作可靠並防止過熱，請勿堵塞或覆蓋開口。
- 請勿將本產品置放於靠近熱源的地方。除非有正常的通風，否則不可放在密閉位置中。
- 不要私自拆開機殼或自行維修，如產品有故障請與原廠或代理商聯繫。

設備名稱：AC1200 Wireless Dual Band Gigabit Router Router		型號（型式）：MR30G				
Equipment name		Type designation (Type)				
單元 Unit	限用物質及其化學符號 Restricted substances and its chemical symbols					
	鉛 Lead (Pb)	汞 Mercury (Hg)	鎘 Cadmium (Cd)	六價鉻 Hexavalent chromium (Cr ⁺⁶)	多溴聯苯 Polybrominated biphenyls (PBB)	多溴二苯醚 Polybrominated diphenyl ethers (PBDE)
PCB	○	○	○	○	○	○
外殼	○	○	○	○	○	○
電源供應器	—	○	○	○	○	○
天線	○	○	○	○	○	○

備考 1. “超出 0.1 wt %” 及 “超出 0.01 wt %” 係指限用物質之百分比含量超出百分比含量基準值
 Note 1: “Exceeding 0.1 wt %” and “exceeding 0.01 wt %” indicate that the percentage content of the restricted substance exceeds the reference percentage value of presence condition.

備考 2. “o” 係指該項限用物質之百分比含量未超出百分比含量基準值。
 Note 2: “o” indicates that the percentage content of the restricted substance does not exceed the percentage of reference value of presence.

備考 3. “-” 係指該項限用物質為排除項目。
 Note 3: The “-” indicates that the restricted substance corresponds to the exemption.



Продукт сертифіковано згідно с правилами системи УкрСЕПРО на відповідність вимогам нормативних документів та вимогам, що передбачені чинними законодавчими актами України.



Safety Information

- Keep the device away from water, fire, humidity or hot environments.
- Do not attempt to disassemble, repair, or modify the device. If you need service, please contact us.
- Do not use damaged charger or USB cable to charge the device.
- Do not use any other chargers than those recommended
- Do not use the device where wireless devices are not allowed.
- Adapter shall be installed near the equipment and shall be easily accessible.
- Use only power supplies which are provided by manufacturer and in the original packing of this product. If you have any questions, please don't hesitate to contact us.

Please read and follow the above safety information when operating the device. We cannot guarantee that no accidents or damage will occur due to improper use of the device. Please use this product with care and operate at your own risk.

Explanation of the symbols on the product label

Symbol	Explanation
	DC voltage
	Class II equipment
	Polarity of d.c. power connector
	Energy efficiency Marking
	Indoor use only
	Operator's manual



RECYCLING

This product bears the selective sorting symbol for Waste electrical and electronic equipment (WEEE). This means that this product must be handled pursuant to European directive 2012/19/EU in order to be recycled or dismantled to minimize its impact on the environment.

User has the choice to give his product to a competent recycling organization or to the retailer when he buys a new electrical or electronic equipment.

CONTENTS

Conventions	01
Chapter 1 Introduction	02
1.1 Product Overview	02
1.2 Product Appearance	02
1.2.1 The Front Panel	02
1.2.2 The Rear Panel	03
Chapter 2 Connect to the Internet	04
2.1. Position Your Router	04
2.2. Connect to the Internet	04
2.2.1. Router Mode	04
2.2.2. Access Point Mode	06
Chapter 3 Log In to the Router	08
Chapter 4 Configure the Router in Wireless Router Mode	09
4.1. Operation Mode	09
4.2. Network	10
4.2.1. Status	10
4.2.2. Internet	11
4.2.3. MAC Clone	17
4.2.4. NAT	18
4.2.5. LAN	18
4.2.6. IPTV/VLAN	19
4.2.7. DHCP Server	19
4.2.8. Dynamic DNS	21
4.2.9. Static Routing	22
4.3. Wireless	24
4.3.1. Wireless Settings	24
4.3.2. Guest Network	25
4.3.3. Wireless Schedule	26
4.3.4. WPS	27
4.3.5. Additional Settings	29
4.4. NAT Forwarding	30

4. 4. 1. Port Forwarding.....	30
4. 4. 2. Port Triggering.....	32
4. 4. 3. UPnP.....	33
4. 4. 4. DMZ.....	34
4. 5. Parental Controls.....	35
4. 6. QoS.....	38
4. 7. Security.....	38
4. 7. 1. Firewall.....	39
4. 7. 2. Access Control.....	39
4. 7. 3. IP & MAC Binding.....	41
4. 8. ALG.....	42
4. 9. IPv6.....	42
4. 10. System.....	45
4. 10. 1. Firmware Upgrade.....	45
4. 10. 2. Backup & Restore.....	46
4. 10. 3. Change Password.....	47
4. 10. 4. Local Management.....	47
4. 10. 5. Remote Management.....	48
4. 10. 6. System Log.....	50
4. 10. 7. Diagnostics.....	51
4. 10. 8. Time.....	52
4. 10. 9. Language.....	54
4. 10. 10. Reboot.....	54
4. 10. 11. LED Control.....	55
Chapter 5. Configure the Router in Access Point Mode.....	56
5. 1. Operation Mode.....	56
5. 2. Firmware Upgrade.....	57
5. 3. Backup & Restore.....	57
5. 4. Administration.....	58
5. 4. 1. Change Password.....	58
5. 4. 2. Local Management.....	59
5. 5. System Log.....	60
5. 6. Diagnostics.....	60

5. 7. Time.....	62
5. 8. Reboot.....	63
5. 9. LED Control	64
Appendix A: FAQ (Frequently Asked Questions)	65
Appendix B: Configuring the PC.....	66

Conventions

The Router, or MR30G, mentioned in this User Guide stands for AC1200 Wireless Dual Band Gigabit Router without any explanations.

Parameters provided in the pictures are just references for setting up the product, which may differ from the actual situation.

You can set the parameters according to your demand.

More Info

Specifications and the latest software can be found at the product page at the official website <http://www.mercusys.com>.

The Quick Installation Guide can be found where you find this guide or inside the package of the router.

Speed/Coverage Disclaimer

*Maximum wireless signal rates are the physical rates derived from IEEE Standard 802.11 specifications. Actual wireless data throughput and wireless coverage are not guaranteed and will vary as a result of 1) environmental factors, including building materials, physical objects, and obstacles, 2) network conditions, including local interference, volume and density of traffic, product location, network complexity, and network overhead, and 3) client limitations, including rated performance, location, connection, quality, and client condition.

**Use of MU-MIMO requires clients to also support MU-MIMO.

Chapter 1 Introduction

1.1 Product Overview

Complying with the powerful 802.11ac standard, MR30G delivers blazing fast Wi-Fi speeds up to 1200 Mbps. Choose the 300 Mbps (2.4 GHz) for internet surfing, email, and social media or 867 Mbps (5 GHz) for bandwidth-intensive tasks like HD streaming and gaming.†

1.2 Product Appearance

1.2.1 The Front Panel



The router's status LED is located on the top.

Name	Status	Indication
SYS	Off	Power is off.
	Solid Orange	The router is functioning normally but the wireless networks are disabled
	Flashing	Flashing quickly: The WPS connection is in progress Flashing slowly: The router is starting up or upgrading.
	Solid Green	The router is functioning normally and the wireless networks are enabled.

1.2.2 The Rear Panel

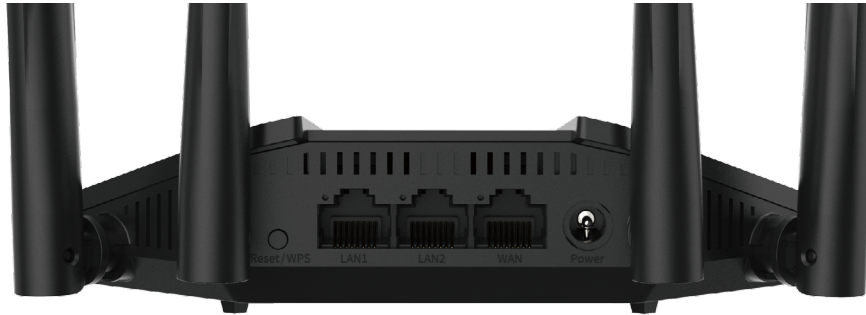

The following items are located on the rear panel (View from left to right).

Item	Description
WPS/RESET Button	Press this button for 1 second to use WPS function. Press and hold this button for more than 5 seconds to reset the router.
LAN1, LAN2 Port	These ports connect the router to the local devices.
WAN Port	This port is where you will connect the router to the DSL/Cable Modem, or Ethernet.
POWER Socket	The power socket is where you will connect the power adapter. Please use the power adapter provided with this router.
Wireless Antennas	To receive and transmit the wireless data.

Item	Indication
WAN Port LED	Wireless Router Mode: Off: The WAN port is not connected. Flashing: The WAN port is connected, but the internet is not available. On: The WAN port is connected. Access Point Mode: Off: The WAN port is not connected. On: The WAN port is connected.
LAN Port LED	Off: The LAN port is not connected. On: The LAN port is connected.

Chapter 2 Connect to the Internet

2.1. Position Your Router

- The product should not be located in a place where it will be exposed to moisture or excessive heat.
- Place the router in a location where it can be connected to multiple devices as well as to a power source.
- Make sure the cables and power cord are safely placed out of the way so they do not create a tripping hazard.
- The router can be placed on a shelf or desktop.
- Keep the router away from devices with strong electromagnetic reference, such as Bluetooth devices, cordless phones and microwaves.

Generally, the router is placed on a horizontal surface, such as on a shelf or desktop. The device also can be mounted on the wall as shown in the following figure.

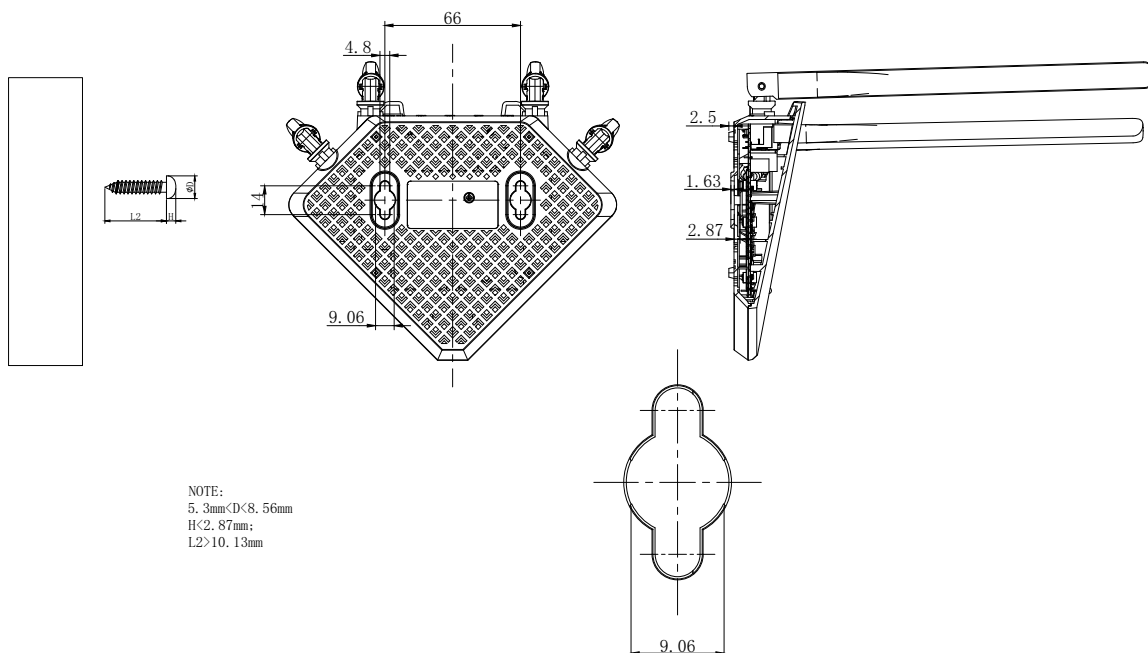

Note:

The diameter of the screw, $5.3\text{mm} < D < 8.56\text{mm}$. The distance of two screws is 66 mm. The screw that project from the wall need around 2.7 mm based, and the length of the screw need to be at least 10.13 mm to withstand the weight of the product.

2.2. Connect to the Internet

The Router provides two working modes: **Router Mode** and **Access Point Mode**. You can choose the mode to better suit your network needs and follow the guide to complete the configuration.

2.2.1. Router Mode

In this mode, the router can provide internet access for multiple wired and wireless devices. This mode is required most commonly.



1. Follow the steps below to connect your router.

If your Internet connection is through an Ethernet cable from the wall instead of through a DSL/Cable/Satellite modem, connect the Ethernet cable directly to the router's Internet/WAN port, then connect the power adapter to the router.

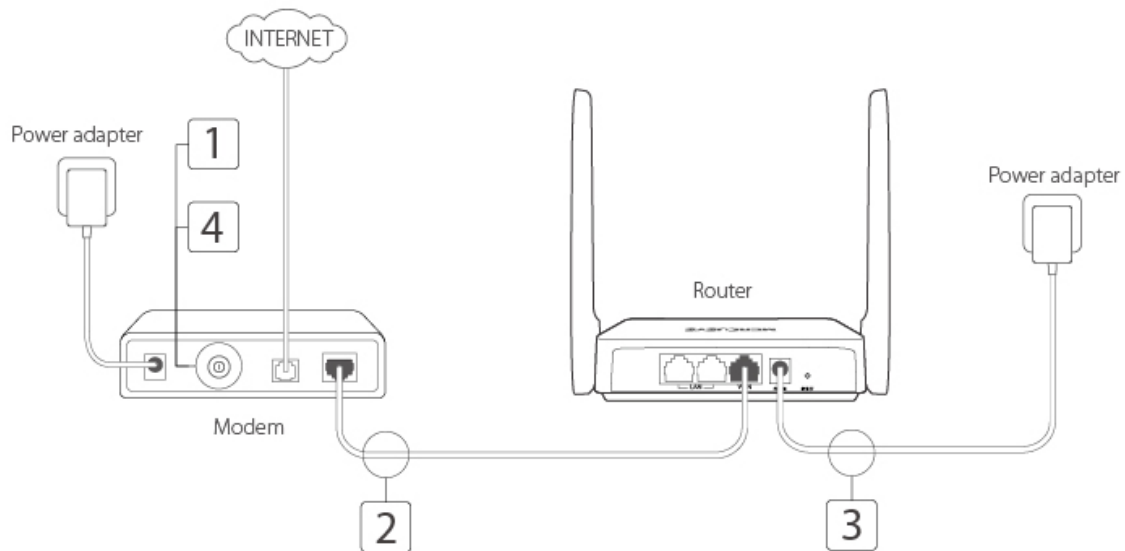

- 1) Turn off the modem, and remove the backup battery if it has one.
 - 2) Connect the modem to the router's WAN port with an Ethernet cable.
 - 3) Connect the power adapter to the router.
 - 4) Turn on the modem, and then wait about **2 minutes** for it to restart.
2. Connect your computer to the router.
- **Method 1: Wired**
Turn off the Wi-Fi on your computer and connect the devices as shown below.
 - **Method 2: Wirelessly**
 - 1) Find the SSID (Network Name) printed on the label at the bottom of the router.
 - 2) Click the network icon of your computer or go to Wi-Fi Settings of your smart device, and then select the SSID to join the network.

3. Enter **http://mwlogin.net** in the address bar of a web browser. Create a password to log in.

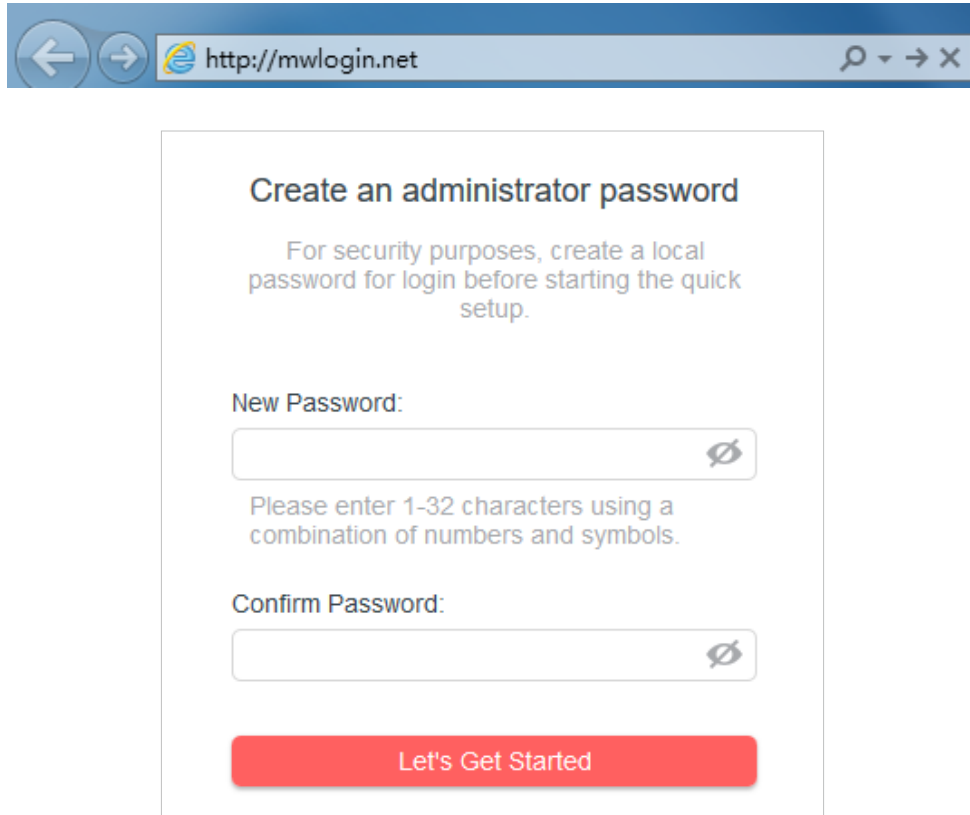

Create an administrator password

For security purposes, create a local password for login before starting the quick setup.

New Password:

Please enter 1-32 characters using a combination of numbers and symbols.

Confirm Password:

Let's Get Started

Note:

If the above screen does not pop-up, it means that your IE Web-browser has been set to a proxy. Go to menu **Tools** > **Internet Options** > **Connections** > **LAN Settings**, in the screen that appears, untick the **Using Proxy** checkbox, and click **OK**.

4. Follow the **Quick Setup** to set up the internet connection.
5. **Enjoy!** For wireless devices, you may have to reconnect to the wireless network if you have customized the SSID (wireless name) and password during the configuration.

2.2.2. Access Point Mode

In this mode, the router changes an existing wired network into a wireless one.

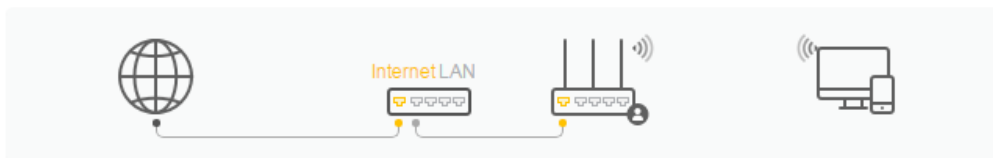

1. Connect the power adapter to the router.
2. Connect the router's WAN port (recommended) to your wired host router's LAN port via an Ethernet cable as shown above.

3. Connect a computer to the router via an Ethernet cable or wirelessly by using the SSID (network name) printed on the bottom label of the router.
4. Enter **<http://mwlogin.net>** in the address bar of a web browser. Create a password to log in.

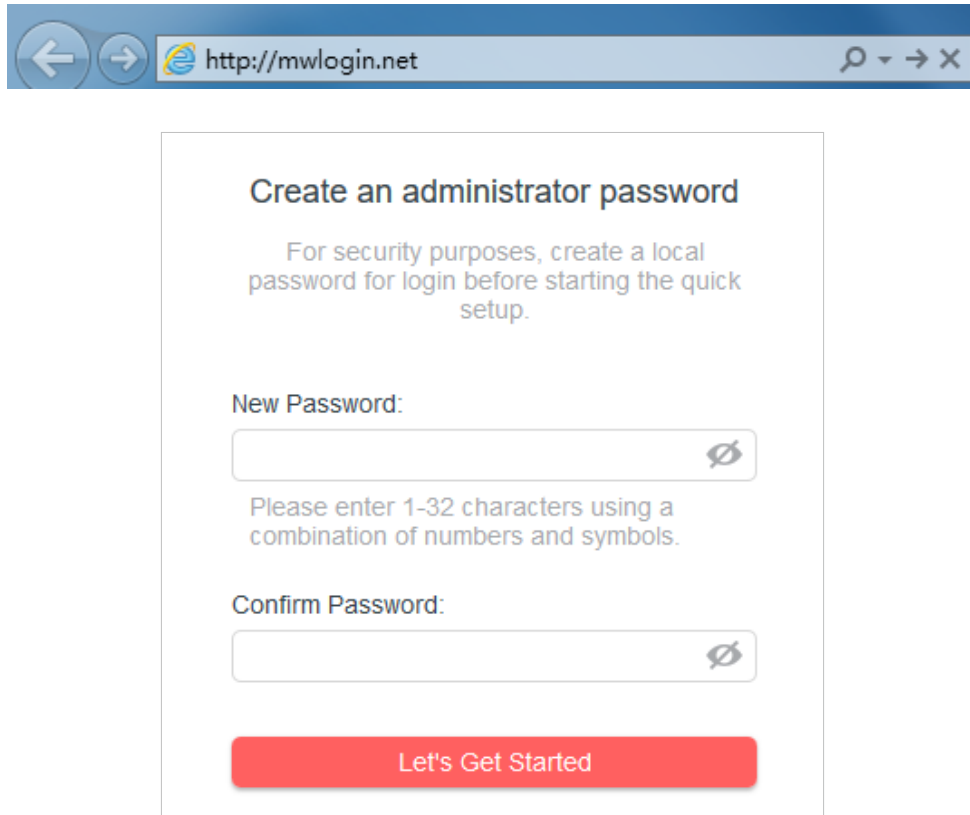

The screenshot shows a web browser window with the address bar containing <http://mwlogin.net>. The main content area displays the following text:

Create an administrator password

For security purposes, create a local password for login before starting the quick setup.

New Password:

Please enter 1-32 characters using a combination of numbers and symbols.

Confirm Password:

Note:

If the above screen does not pop-up, it means that your IE Web-browser has been set to a proxy. Go to menu Tools > Internet Options > Connections > LAN Settings, in the screen that appears, untick the Using Proxy checkbox, and click OK.

5. Click **Change Mode** in the top right corner and select **Access Point Mode**. Wait for the router to reboot.
6. Follow the **Quick Setup** to set up the internet connection.
7. **Enjoy!** Connect to the wireless network by using the SSID (network name) and password of the router.

Chapter 3 Log In to the Router

This chapter introduces how to log in to the web management page of the router.

With the web-based utility, it is easy to configure and manage the router. The web-based utility can be used on any Windows, Macintosh or UNIX OS with a Web browser, such as Microsoft the Internet Explorer, Mozilla Firefox or Apple Safari.

Follow the steps below to log in to your router.

1. Set up the TCP/IP Protocol in Obtain an IP address automatically mode on your computer.
2. Visit <http://mwlogin.net>, and log in with the password you set for the router.

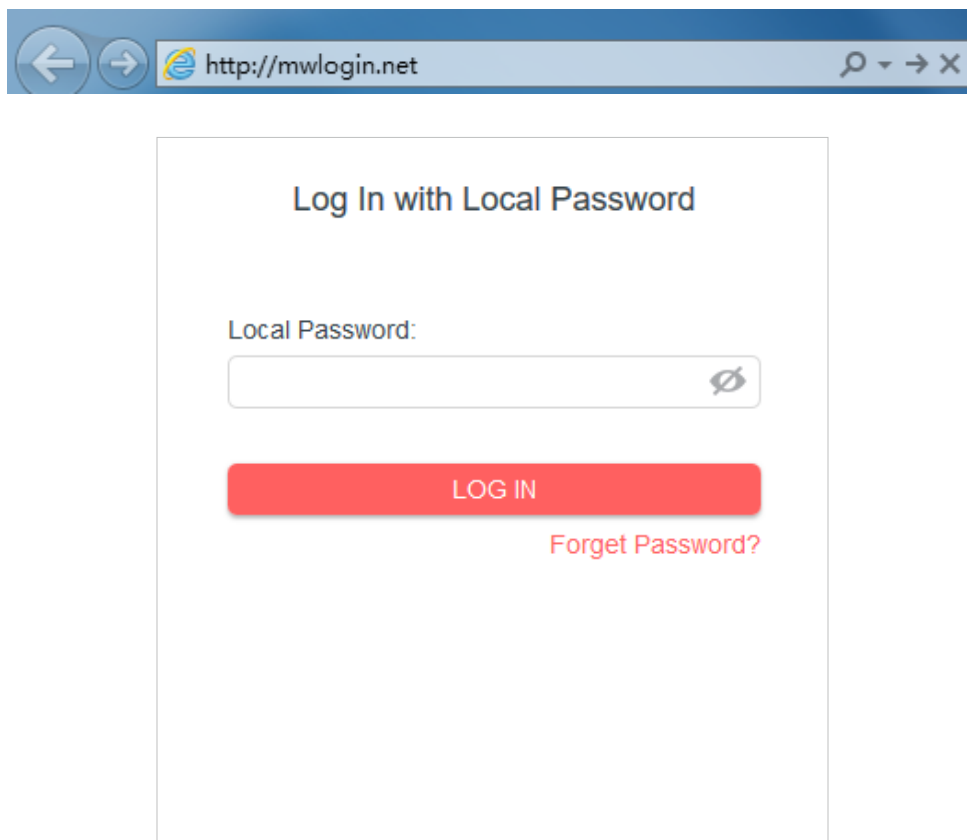

Note:

If the login window does not appear, please refer to the [FAQ](#) section.

Chapter 4. Configure the Router in Wireless Router Mode

This chapter presents how to configure the various features of the router working as a wireless router.

It contains the following sections:

- **Operation Mode**
- **Network**
- **Wireless**
- **NAT Forwarding**
- **Parental Controls**
- **QoS**
- **Security**
- **IPv6**
- **System**

4. 1. Operation Mode

1. Visit <http://mwlogin.net>, and log in with the password you set for the router.
2. Go to **System > Operation Mode**.
3. Select the working mode as needed and click **SAVE**.

Operation Mode

Select an operation mode according to your needs.

Wireless Router Mode (Current)

In this mode, the router can provide internet access for multiple wired and wireless devices. This mode is required most commonly.



Access Point Mode

In this mode, the router changes an existing wired (Ethernet) network into a wireless one.

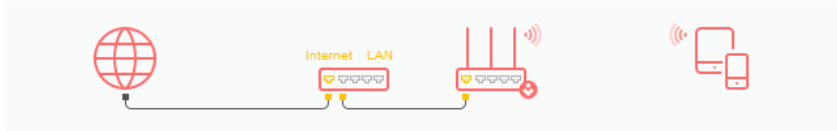

4.2. Network

4.2.1. Status

1. Visit <http://mwlogin.net>, and log in with password you set for the router.
2. Go to **Advanced > Network > Status**. You can view the current status information of the router.

Status

Internet status overview is displayed on this page.

Internet

Status: Disconnected

Internet Connection Type: Static IP

IP Address: 2.2.2.2

Subnet Mask: 255.255.0.0

Default Gateway: 3.3.3.3

Primary DNS: 4.4.4.4

Secondary DNS: 5.5.5.5

LAN

MAC Address: 88-CD-04-81-92-55

IP Address: 192.168.1.14

Subnet Mask: 255.255.255.0

IPTV/VLAN

LAN1: Internet

LAN2: Internet

LAN3: VoIP

LAN4: IPTV

DHCP Server

DHCP Server: Disabled

Dynamic DNS

Service Provider: DynDNS

Host Name: a.cn

Status: Connecting...

- **Internet** - This field displays the current settings of the internet, and you can configure them on the **Advanced > Network > Internet** page.

- **Status** - Indicates whether the router has been connected to the internet.
 - **Internet Connection Type** - Indicates the way in which your router is connected to the internet.
 - **IP Address** - The WAN IP address of the router.
 - **Subnet Mask** - The subnet mask associated with the WAN IP address.
 - **Default Gateway** - The Gateway currently used is shown here. When you use Dynamic IP as the internet connection type, click **Renew** or **Release** here to obtain new IP parameters dynamically from the ISP or release them.
 - **Primary & Secondary DNS** - The IP addresses of DNS (Domain Name System) server.
- **LAN** - This field displays the current settings of the LAN, and you can configure them on the **Advanced > Network > LAN page**.
 - **MAC Address** - The physical address of the router.
 - **IP Address** - The LAN IP address of the router.
 - **Subnet Mask** - The subnet mask associated with the LAN IP address.
 - **DHCP Server** - This field displays the current settings of DHCP (Dynamic Host Configuration Protocol) Server, and you can configure them on the **Network > DHCP Server** page.
 - **DHCP Server** - Indicates whether the DHCP server is enabled or disabled. It is enabled by default and the router acts as a DHCP server.
 - **IP Address Pool** - The IP address range for the DHCP server to assign IP addresses.
 - **Dynamic DNS** - This field displays the current settings of the Dynamic DNS (Domain Name System), and you can configure them on the **Advanced > Network > Dynamic DNS** page.
 - **Service Provider** - The Dynamic DNS service provider you have signed up for.
 - **Host Name** - The Domain Name you have entered in the Dynamic DNS page.
 - **Status** - The status of the Dynamic DNS service connection.

4.2.2. Internet

1. Visit <http://mwlogin.net>, and log in with the password you set for the router.
2. Go to **Advanced > Network > Internet**.
3. Set up the internet connection and click **SAVE**.

Dynamic IP

If your ISP provides the DHCP service, please select **Dynamic IP**, and the router will automatically get IP parameters from your ISP.

Click **RENEW** to renew the IP parameters from your ISP.

Click **RELEASE** to release the IP parameters.

- **MTU Size** - The normal MTU (Maximum Transmission Unit) value for most Ethernet networks is 1500 Bytes. It is not recommended that you change the default MTU size unless required by your ISP.
- **Host Name** - This option specifies the name of the router.
- **Get IP with Unicast DHCP** - A few ISPs' DHCP servers do support the broadcast applications. If you cannot get the IP address normally, you can choose this option (it is rarely required).

Static IP

If your ISP provides a static or fixed IP address, subnet mask, default gateway and DNS setting, please select **Static IP**.

- **IP Address** - Enter the IP address in dotted-decimal notation provided by your ISP.
- **Subnet Mask** - Enter the subnet mask in dotted-decimal notation provided by your ISP. Normally 255.255.255.0 is used as the subnet mask.
- **Default Gateway** - Enter the gateway IP address in dotted-decimal notation provided by your ISP.
- **Primary/Secondary DNS** - (Optional) Enter one or two DNS addresses in dotted-decimal notation provided by your ISP.
- **MTU Size** - The normal MTU (Maximum Transmission Unit) value for most Ethernet networks is 1500 bytes. It is not recommended that you change the default MTU size unless required by your ISP.

PPPoE

If your ISP provides PPPoE connection, select **PPPoE**.

Internet

Set up an internet connection with the service information provided by your ISP (internet service provider).

Internet Connection Type:

Username:

Password:

IP Address: 0.0.0.0

Primary DNS: 0.0.0.0

Secondary DNS: 0.0.0.0

▼ Advanced Settings

Secondary Connection:

MTU Size: bytes
The default is 1480, do not change unless necessary.

Service Name:
(Leave blank unless ISP requires.)

Access Concentrator Name:
(Leave blank unless ISP requires.)

Detect Online Interval: seconds

IP Address:

DNS Address:

Primary DNS: 0.0.0.0

Secondary DNS: 0.0.0.0

Connection Mode:
(Disconnect after max idle time and reconnect on demand.)

Max Idle Time: minutes
(0 means always connected.)

- **Username/Password** - Enter the user name and password provided by your ISP. These fields are case-sensitive.
- **Secondary Connection** - It's available only for PPPoE connection. If your ISP provides an extra connection type, select **Dynamic IP** or **Static IP** to activate the secondary connection.

- **MTU Size** - The default MTU size is 1480 bytes. It is not recommended that you change the default MTU size unless required by your ISP.
- **Service Name** - The service name should not be configured unless you are sure it is necessary for your ISP. In most cases, leaving these fields blank will work.
- **Access Concentrator Name** - The access concentrator name should not be configured unless you are sure it is necessary for your ISP. In most cases, leaving these fields blank will work.
- **Detect Online Interval** - The router will detect Access Concentrator online at every interval. The default value is 10. You can input the value between 0 and 120. The value 0 means no detect.
- **IP Address** - The default setting is to get an IP address dynamically from your ISP. If your ISP does not automatically assign IP addresses to the router, please select **Use the Following IP Address** and enter the IP address provided by your ISP in dotted-decimal notation.
- **DNS Address** - The default setting is to get an IP address dynamically from your ISP. If your ISP does not automatically assign DNS addresses to the router, please select **Use the Following DNS Addresses** and enter the IP address in dotted-decimal notation of your ISP's primary DNS server. If a secondary DNS server address is available, enter it as well.
- **Connection Mode** - Select an appropriate connection mode that determines how to connect to the internet.
 - **Auto** - In this mode, the internet connection reconnects automatically any it gets disconnected.
 - **On Demand** - In this mode, the internet connection will be terminated automatically after a specified inactivity period (Max Idle Time) and be re-established when you attempt to access the internet again.
 - **Time-based** - In this mode, the internet connection is only established in a specific timeframe. If this option is selected, enter the start time and end time. Both are in HH:MM format.
 - **Manual** - In this mode, the internet connection is controlled manually by clicking the **Connect/Disconnect** button. This mode also supports the **Max Idle Time** function as **On Demand** mode. Enter a maximum time (in minutes), the internet connection can be inactive before it is terminated into the Max Idle Time. The default value is 15 minutes. If you want the internet connection remains active all the time, enter 0 (zero).

Note:

Sometimes the connection cannot be terminated although you have specified the **Max Idle Time** because some applications are visiting the internet continually in the background.

L2TP

If your ISP provides L2TP connection, please select **L2TP**.

Internet

Set up an internet connection with the service information provided by your ISP (internet service provider).

Internet Connection Type:

Username:

Password:

IP Address: 0.0.0.0

Primary DNS: 0.0.0.0

Secondary DNS: 0.0.0.0

Dynamic IP

Static IP

VPN Server IP/Domain Name:

IP Address: 0.0.0.0

Subnet Mask: 0.0.0.0

Default Gateway: 0.0.0.0

Primary DNS: 0.0.0.0

Secondary DNS: 0.0.0.0

MTU Size:

The default is 1460, do not change unless necessary.

Connection Mode:

- **Username/Password** - Enter the username and password provided by your ISP. These fields are case-sensitive.
- **VPN Server IP/ Domain Name** - Enter the VPN server's IP address or domain name provided by your ISP.
- **MTU Size** - The default MTU size is "1460" bytes, which is usually fine. It is not recommended that you change the default MTU Size unless required by your ISP.
- **Connection Mode**
 - **Auto** - In this mode, the internet connection reconnects automatically any it gets disconnected.

- **On Demand** - In this mode, the internet connection will be terminated automatically after a specified inactivity period (Max Idle Time) and be re-established when you attempt to access the internet again.
- **Manual** - In this mode, the internet connection is controlled manually by clicking the **Connect/Disconnect** button. This mode also supports the **Max Idle Time** function as **On Demand** mode. Enter a maximum time (in minutes), the internet connection can be inactive before it is terminated into the Max Idle Time. The default value is 15 minutes. If you want the internet connection remains active all the time, enter 0 (zero).

Note:

Sometimes the connection cannot be terminated although you have specified the **Max Idle Time** because some applications are visiting the internet continually in the background.

PPTP

If your ISP provides PPTP connection, please select **PPTP**.

Internet

Set up an internet connection with the service information provided by your ISP (internet service provider).

Internet Connection Type:

Username:

Password:

IP Address: 0.0.0.0

Primary DNS: 0.0.0.0

Secondary DNS: 0.0.0.0

Dynamic IP
 Static IP

VPN Server IP/Domain Name:

IP Address: 0.0.0.0

Subnet Mask: 0.0.0.0

Default Gateway: 0.0.0.0

Primary DNS: 0.0.0.0

Secondary DNS: 0.0.0.0

MTU Size:
The default is 1420, do not change unless necessary.

Connection Mode:

- **Username/Password** - Enter the username and password provided by your ISP. These fields are case-sensitive.
- **VPN Server IP/ Domain Name** - Enter the VPN server's IP address or domain name provided by your ISP.
- **MTU Size** - The default MTU size is "1420" bytes, which is usually fine. It is not recommended that you change the default MTU Size unless required by your ISP.
- **Connection Mode**
 - **Auto** - In this mode, the internet connection reconnects automatically any it gets disconnected.
 - **On Demand** - In this mode, the internet connection will be terminated automatically after a specified inactivity period (Max Idle Time) and be re-established when you attempt to access the internet again.
 - **Manual** - In this mode, the internet connection is controlled manually by clicking the **Connect/Disconnect** button. This mode also supports the **Max Idle Time** function as **On Demand** mode. Enter a maximum time (in minutes), the internet connection can be inactive before it is terminated into the Max Idle Time. The default value is 15 minutes. If you want the internet connection remains active all the time, enter 0 (zero).

Note:

Sometimes the connection cannot be terminated although you have specified the **Max Idle Time** because some applications are visiting the internet continually in the background.

4.2.3. MAC Clone

1. Visit <http://mwlogin.net>, and log in with the password you set for the router.
2. Go to **Advanced > Network > Internet** and locate the MAC Clone section.
3. Configure **Router MAC Address** and click **SAVE**.

- **Use Default MAC Address** - Do not change the default MAC address of your router in case the ISP does not bind the assigned IP address to the MAC address.

- **Use Current MAC Address** - Select to copy the current MAC address of the computer that is connected to the router, in case the ISP binds the assigned IP address to the MAC address.
- **Use Custom MAC Address** - Select if your ISP requires you to register the MAC address and enter the correct MAC address in this field, in case the ISP binds the assigned IP address to the specific MAC address.

Note:

- You can only use the MAC Address Clone function for PCs on the LAN.
- If you have changed the WAN MAC address when the WAN connection is PPPoE, it will not take effect until the connection is re-established.

4.2.4. NAT

1. Visit <http://mwlogin.net>, and log in with the password you set for the router.
2. Go to **Advanced > Network > Internet** and locate the NAT section.
3. Configure **NAT** and NAT Boost, then click **SAVE**.

Note:

- NAT Boost will not be able to configure or take effect when QoS feature is enabled.

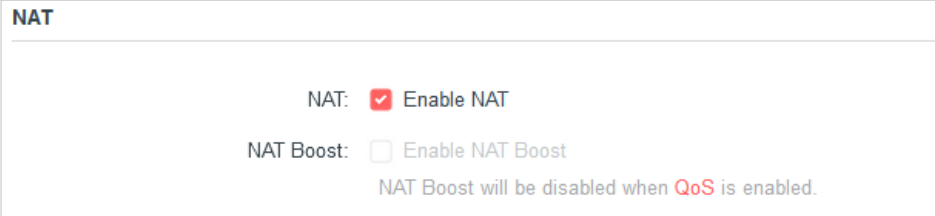

NAT

NAT: Enable NAT

NAT Boost: Enable NAT Boost

NAT Boost will be disabled when QoS is enabled.

4.2.5. LAN

1. Visit <http://mwlogin.net>, and log in with the password you set for the router.
2. Go to **Advanced > Network > LAN**.
3. Configure the IP parameters of the LAN and click **SAVE**.

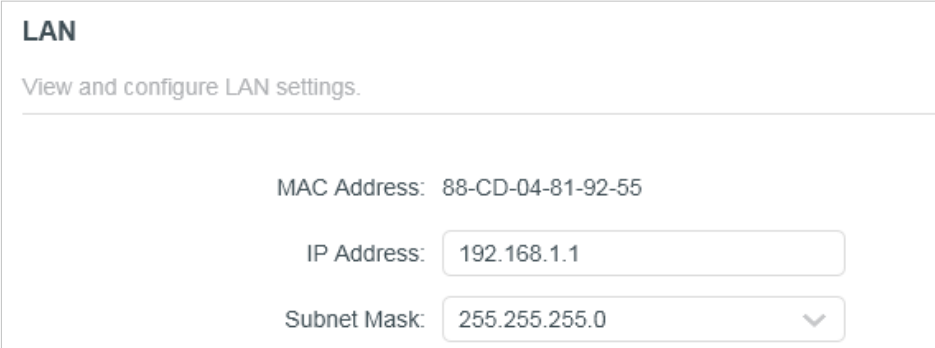

LAN

View and configure LAN settings.

MAC Address: 88-CD-04-81-92-55

IP Address:

Subnet Mask: ▼

- **MAC Address** - The physical address of the LAN ports. The value can not be changed.
- **IP Address** - Enter the IP address in dotted-decimal notation of your router (the default one is 192.168.1.1).

- **Subnet Mask** - An address code that determines the size of the network. Normally 255.255.255.0 is used as the subnet mask.

Note:

- If you have changed the IP address, you must use the new IP address to log in.
- If the new IP address you set is not in the same subnet as the old one, the IP address pool in the DHCP Server will be configured automatically, but the Virtual Server and DMZ Host will not take effect until they are re-configured.

4.2.6. IPTV/VLAN

1. Visit <http://mwlogin.net>, and log in with the password you set for the router.
2. Go to **Advanced > Network > IPTV/VLAN**.
3. Configure IPTV/VLAN settings if you want to enjoy IPTV or VoIP service, or if your ISP requires VLAN tags.

IPTV/VLAN

Configure IPTV/VLAN settings if you want to enjoy IPTV or VoIP service, or if your ISP requires VLAN tags.

IPTV/VLAN: Enable

Mode:

LAN1:

LAN2:

LAN3:

- **IPTV/VLAN** - Select to enable the IPTV feature.
- **Mode** - Select the appropriate mode according to your ISP.
- **LAN 1/2/3** - Assign your LAN port to whether function as the internet supplier or as the IPTV supplier.

4.2.7. DHCP Server

By default, the DHCP (Dynamic Host Configuration Protocol) Server is enabled and the router acts as a DHCP server; it dynamically assigns TCP/IP parameters to client devices from the IP Address Pool. You can change the settings of DHCP Server if necessary, and you can reserve LAN IP addresses for specified client devices.

- **To specify the IP address that the router assigns:**

1. Visit <http://mwlogin.net>, and log in with the password you set for the router.
2. Go to **Advanced > Network > DHCP Server** and locate the DHCP Server section.

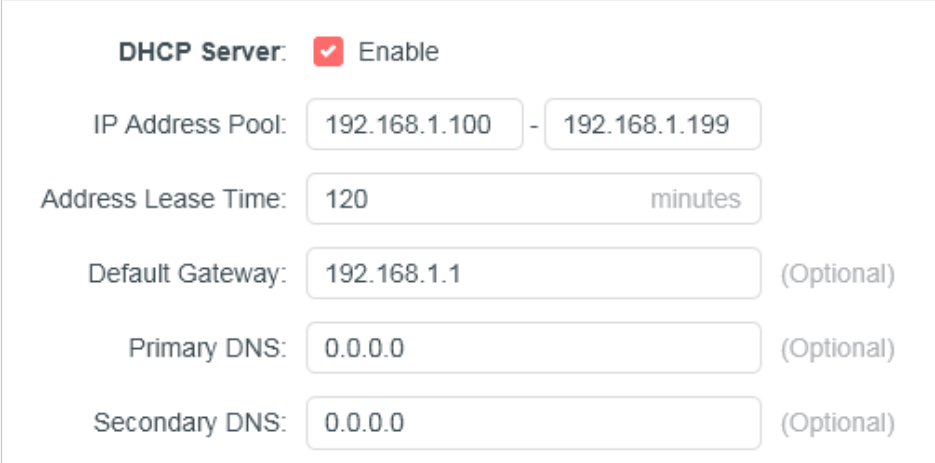

DHCP Server: Enable

IP Address Pool: 192.168.1.100 - 192.168.1.199

Address Lease Time: 120 minutes

Default Gateway: 192.168.1.1 (Optional)

Primary DNS: 0.0.0.0 (Optional)

Secondary DNS: 0.0.0.0 (Optional)

1. Tick the **Enable** checkbox.
2. Enter the starting and ending IP addresses in the **IP Address Pool**.
3. Enter other parameters if the ISP offers. The **Default Gateway** is automatically filled in and is the same as the LAN IP address of the router.
4. Click **SAVE**.

Note:

To use the DHCP server function of the router, you must configure all computers on the LAN as Obtain an IP Address automatically.

- **To reserve an IP address for a specified client device:**

1. Visit <http://mwlogin.net>, and log in with the password you set for the router.
2. Go to **Advanced > Network > DHCP Server** and locate the **Address Reservation** section.
3. Click **Add** in the **Address Reservation** section.

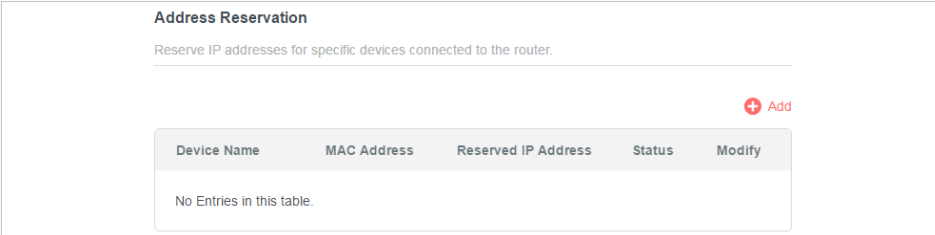

Address Reservation

Reserve IP addresses for specific devices connected to the router.

[+ Add](#)

Device Name	MAC Address	Reserved IP Address	Status	Modify
No Entries in this table.				

4. Click **VIEW CONNECTED DEVICES** and select the you device you want to reserve an IP for. Then the **MAC and IP Address** will be automatically filled in. You can also enter the **MAC and IP address** of the client device.

Add a Reservation Entry
✕

MAC Address:

[VIEW CONNECTED DEVICES](#)

IP Address:

[CANCEL](#)
[SAVE](#)

• **To check the DHCP client list:**

1. Visit <http://mwlogin.net>, and log in with the password you set for the router.
2. Go to **Advanced > Network > DHCP Server** and locate the **DHCP Client List** section. You can see the device information of the list.
3. Click **Refresh** to see the current attached devices.

DHCP Client List

View the devices that are currently assigned with IP addresses by the DHCP server.

Total Clients: 66 [Refresh](#)

Device Name	MAC Address	Assigned IP Address	Lease Time
-PC	40-8D-5C-69-BD-B8	192.168.1.100	01:55:42

4. 2. 8. Dynamic DNS

The router offers the DDNS (Dynamic Domain Name System) feature, which allows the hosting of a website, FTP server, or e-mail server with a fixed domain name (named by yourself) and a dynamic IP address. Thus your friends can connect to your server by entering your domain name no matter what your IP address is. Before using this feature, you need to sign up for DDNS service providers such as www.comexe.cn, www.dyndns.org, or www.noip.com. The Dynamic DNS client service provider will give you a password or key.

1. Visit <http://mwlogin.net>, and log in with the username and password you set for the router.
2. Go to **Advanced > Network > Dynamic DNS**.
3. Select the **DDNS Service Provider**: NO-IP or DynDNS. If you don't have a DDNS account, you have to register first by clicking **Register Now**.

Dynamic DNS

Assign a fixed host name (domain name) for remote access to your device, website, or server behind the router.

Service Provider: Register Now

Username:

Password: 

Domain Name:

Status: Connecting...

4. Enter the **Username** for your DDNS account.
5. Enter the **Password** for your DDNS account.
6. Enter the **Domain Name** you received from dynamic DNS service provider here.
7. If your service provider is NO-IP, select **WAN IP binding** to ensure that the domain name is bound to the WAN IP of this router.
8. Click **LOGIN AND SAVE**.

4.2.9. Static Routing

Static Routing is a form of routing that is configured manually by a network administrator or a user by adding entries into a routing table. The manually-configured routing information guides the router in forwarding data packets to the specific destination.

I want to:

Visit multiple networks and servers at the same time.

For example, in a small office, my PC can surf the internet through Router A, but I also want to visit my company's network. Now I have a switch and Router B. I connect the devices as shown in the following figure so that the physical connection between my PC and my company's server is established. To surf the internet and visit my company's network at the same time, I need to configure the static routing.

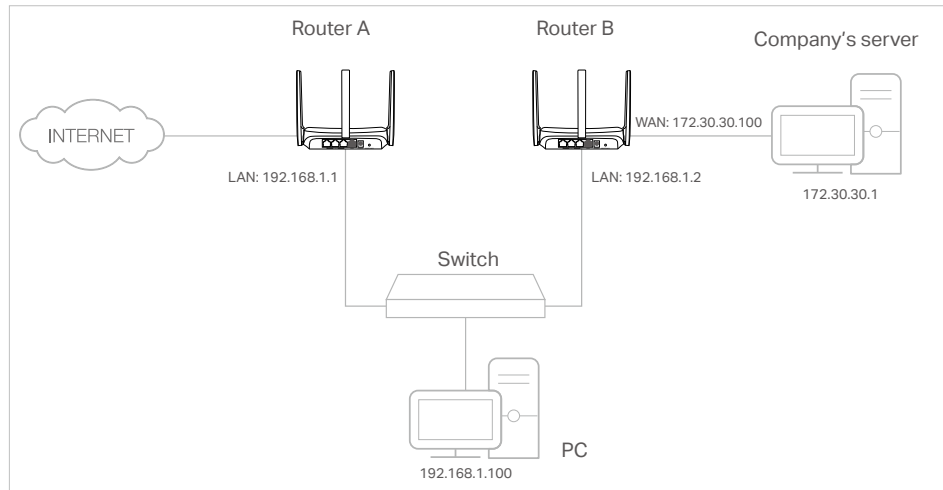

How can I do that?

1. Change the routers' LAN IP addresses to two different IP addresses on the same subnet. Disable Router B's DHCP function.
2. Visit <http://mwlogin.net>, and log in with the password you set for Router A.
3. Go to **Advanced > Network > Routing** and locate the Static Routing section.
4. Click **Add** and finish the settings according to the following explanations:

Add a Routing Entry
✕

Network Destination:

Subnet Mask:

Default Gateway:

Interface: WAN ▼

Description:

CANCEL
SAVE

- **Network Destination** - The destination IP address that you want to assign to a static route. This IP address cannot be on the same subnet with the WAN IP or LAN IP of Router A. In the example, the IP address of the company network is the destination IP address, so here enter 172.30.30.1.
- **Subnet Mask** - The Subnet Mask determines which portion of an IP address is the network portion, and which portion is the host portion.
- **Default Gateway** - The IP address of the gateway device to which the data packets will be sent. This IP address must be on the same subnet with the router's IP which

sends out data. In the example, the data packets will be sent to the LAN port of Router B and then to the Server, so the default gateway should be 192.168.1.2.

- **Interface** - Determined by the port (WAN/LAN) that sends out data packets. In the example, the data are sent to the gateway through the LAN port of Router A, so **LAN** should be selected.
- **Description** - Enter a description for this static routing entry.

5. Click **SAVE**.

6. Check the **Routing Table** below. If you can find the entry you've set, the static routing is set successfully.

4.3. Wireless

4.3.1. Wireless Settings

1. Visit <http://mwlogin.net>, and log in with the password you set for the router.
2. Go to **Advanced > Wireless > Wireless Settings**.
3. Configure the wireless settings for the wireless network and click **SAVE**.

Wireless Settings

Personalize wireless settings as you need.

2.4GHz: Enable Sharing Network

Network Name (SSID): Hide SSID

Security: ▼

Transmit Power: ▼

Channel Width: ▼

Channel: ▼

Mode: ▼

- **2.4GHz** - Select this checkbox to enable the 2.4GHz wireless network.
- **Network Name (SSID)** - Enter a value of up to 32 characters. The same Name (SSID) must be assigned to all wireless devices in your network.
- **Hide SSID** - Select this checkbox if you want to hide the 2.4GHz network name (SSID) from the Wi-Fi network list. In this case, you need to manually join the network.
- **Security** - Select an option from the Security drop-down list.
 - **None** - No security. It is highly recommend you enable the wireless security to protect your wireless network from unauthorized access.

- **WPA-PSK/WPA2-Personal** - It's the WPA/WPA2 authentication type based on pre-shared passphrase. It's also the recommended security type.
- **WPA2/WPA3-Personal** - If you are having WPA3-supported clients, select this option to enjoy stronger protections than WPA/WPA2-Personal.
- **WPA /WPA2-Enterprise** - It's based on Radius Server.
- **Version** - Keep default version value.
- **Encryption** - Select **Auto**, **TKIP** or **AES**. We recommend you keep the default settings.
- **Transmit Power** - Select **High**, **Middle** or **Low** to specify the data transmit power. The default and recommended setting is **High**.
- **Channel Width** - Select a channel width (bandwidth) for the wireless network.
- **Channel** - Select an operating channel for the wireless network. It is recommended to leave the channel to **Auto**, if you are not experiencing the intermittent wireless connection issue.
- **Mode** - You can choose the appropriate "Mixed" mode.

4.3.2. Guest Network

Guest Network allows you to provide Wi-Fi access for guests without disclosing your host network. When you have guests in your house, apartment, or workplace, you can create a guest network for them. In addition, you can customize guest network settings to ensure network security and privacy.

• Create a Guest Network

1. Visit <http://mwlogin.net>, and log in with the password you set for the router.
2. Go to Wireless or **Advanced > Wireless > Guest Network**.
3. Enable the **Guest Network** function.

Guest Network

Create a separate network for your guests to ensure network security and privacy.

2.4GHz: Enable Sharing Network

Network Name (SSID): Hide SSID

Security:

Password:

4. Create a network name for your guest network.
5. Select the **Security** type and create the **Password** of the guest network.
6. Click **SAVE**. Now you guests can access your guest network using the SSID and password you set!

• Customize Guest Network Options

1. Visit <http://mwlogin.net>, and log in with the password you set for the router.
2. Go to **Advanced > Wireless > Guest Network**. Locate the **Guest Permissions** section.
3. Customize guest network options according to your needs.

Guest Permissions

Control the data that guests can access.

Allow guests to see each other
 Allow guests to access your local network

- **Allow guests to see each other**

Tick this checkbox if you want to allow the wireless clients on your guest network to communicate with each other via methods such as network neighbors and Ping.

- **Allow guests to access my local network**

Tick this checkbox if you want to allow the wireless clients on your guest network to communicate with the devices connected to your router's LAN ports or main network via methods such as network neighbors and Ping.

4. Click **SAVE**. Now you can ensure network security and privacy!

4.3.3. Wireless Schedule

The wireless function can be automatically off at a specific time when you do not need the wireless function.

1. Visit <http://mwlogin.net>, and log in with the password you set for the router.
2. Go to **Advanced > Wireless > Wireless Schedule**.
3. Enable the **Wireless Schedule** function.

Wireless Schedule

Schedule when to automatically turn off your wireless network.

Wireless Schedule: Enable

Note: Make sure [Time Settings](#) are correct before using this function.

Current Time: 07:00:00 21-11-20

[+ Add](#)

Wireless Off Time	Repeat	Modify
No Entries in this table.		

4. Click **Add** to specify a wireless off period during which you need the wireless off automatically, and click **SAVE**.

The screenshot shows a dialog box titled "Add Schedule" with a close button (X) in the top right corner. Inside the dialog, there are two dropdown menus for "Wireless Off Time: From" and "To", both set to "01". The "To" dropdown has "(next day)" next to it. Below these are seven circular buttons for days of the week: S, M, T, W, T, F, S. At the bottom are two buttons: "CANCEL" and "SAVE".

Note:

- The effective wireless schedule is based on the time of the router. You can go to **Advanced > System > Time** to modify the time.
- The wireless network will be automatically turned on after the time period you set.

4.3.4. WPS

WPS (Wi-Fi Protected Setup) can help you to quickly and securely connect to a network. This section will guide you to add a new wireless device to your router's network quickly via WPS.

Note:

The WPS function cannot be configured if the wireless function of the router is disabled. Please make sure the wireless function is enabled before configuration.

1. Visit <http://mwlogin.net>, and log in with the password you set for the router.
2. Go to **Advanced > Wireless > WPS**.
3. Follow one of the following methods to connect your client device to the router's Wi-Fi network.

Method 1: Using a PIN

• Connects via the Client's PIN

1. Keep the WPS Status as **Enabled** and select **Client's PIN**.

WPS

Use WPS (Wi-Fi Protected Setup) to connect a client (personal device) to the router's wireless network easily.

WPS:

Method 1: Using a PIN

Client's PIN

Router's PIN

Enter your personal device's PIN here and click **CONNECT**

CONNECT

2. Enter the PIN of your device and click **CONNECT**. Then your device will get connected to the router.

• Connects via the Router's PIN

1. Keep the WPS Status as **Enabled** and select **Router's PIN**.

WPS

Use WPS (Wi-Fi Protected Setup) to connect a client (personal device) to the router's wireless network easily.

WPS:

Method 1: Using a PIN

Client's PIN

Router's PIN

Router's PIN:

Enter the router's PIN on your personal device.
Router's PIN: **39070340**

GET NEW PIN

2. Enter the router's PIN on your personal device. You can also generate a new one.

Note:

PIN (Personal Identification Number) is an eight-character identification number preset to each router. WPS supported devices can connect to your router with the PIN.

Method 2: Using the WPS Button on the Web Screen

Click **Start** on the screen. Within two minutes, enable WPS on your personal device. A **Device-(XX-XX-XX-XX-XX-XX) Connected** message should appear on the screen, indicating successful WPS connection.

Note:

XX-XX-XX-XX-XX-XX is the MAC address of your device.

Method 2: Using the button below

Click the button below, then enable WPS on your personal device within 2 minutes.

**Method 3: Using the WPS Button on the Router**

Press the router's WPS button. Within two minutes, enable WPS on your personal device.

Method 3: Using the router's WPS button

Press the router's WPS button, then enable WPS on your personal device within 2 minutes.

4.3.5. WDS

WDS (Wireless Distribution System) Bridging feature allows you to bridge a router with an access point to extend the wireless network coverage.

Note:

- WDS bridging only requires configuration on the extended router;
- WDS bridging function can be enabled either in 2.4GHz frequency or 5GHz frequency. The WDS function can work at only one of the bands at one time.

1. Visit <http://mwlogin.net>, and log in with the password you set for the router.
2. Configure the router's LAN IP.
 - 1) Go to **Advanced > Network > LAN**.
 - 2) Set the LAN IP to be in the same subnet as the access point/router to be bridged. (For example, if your access point's LAN IP is 192.168.0.1, you can set this router's LAN IP to an address from 192.168.0.2 to 192.168.0.254.)
 - 3) Save the settings.
3. Configure WDS Bridging.
 - 1) Go to **Advanced > Wireless > WDS**.
 - 2) Enable **WDS Bridging** either in 2.4GHz frequency or 5GHz frequency.

2.4GHz WDS

WDS Bridging: Enable WDS Bridging

SSID (to be bridged):

SURVEY

MAC Address:

Security:

5GHz WDS

WDS Bridging: Enable WDS Bridging

The WDS function can work at only one of the two bands at one time.

3) Click **Survey** to and choose the network to be bridged. The SSID (network name) and MAC Address will be automatically filled in. You can also manually fill in these parameters.

4) Set the **Security** type and related parameters to be the same as the network to be bridged.

5) Save the settings.

4. Go to **Advanced > Network > DHCP Server**, and disable **DHCP Server**.

4.3.6. Additional Settings

1. Visit <http://mwlogin.net>, and log in with the password you set for the router.

2. Go to **Advanced > Wireless > Additional Settings**.

3. Configure the advanced settings of your wireless network and click **Save**.

Note:

If you are not familiar with the setting items on this page, it's strongly recommended to keep the provided default values; otherwise it may result in lower wireless network performance.

Additional Settings

Check advanced wireless settings for your device.

WMM: Enable

AP Isolation: Enable

Airtime Fairness: Enable

Beacon Interval:

RTS Threshold:

DTIM Interval:

Group Key Update Period: s

- **WMM** - WMM function can guarantee the packets with high-priority messages being transmitted preferentially.
- **AP Isolation** - This function isolates all connected wireless stations so that wireless stations cannot access each other through WLAN.
- **Airtime Fairness** - This function can improve the overall network performance by sacrificing a little bit of network time on your slow devices.
- **Beacon Interval** - Enter a value between 40-1000 milliseconds for Beacon Interval here. Beacon Interval value determines the time interval of the beacons. The beacons are the packets sent by the router to synchronize a wireless network. The default value is 100.
- **RTS Threshold** - Here you can specify the RTS (Request to Send) Threshold. If the packet is larger than the specified RTS Threshold size, the router will send RTS frames to a particular receiving station and negotiate the sending of a data frame. The default value is 2346.
- **DTIM Interval** - This value determines the interval of the Delivery Traffic Indication Message (DTIM). A DTIM field is a countdown field informing clients of the next window for listening to broadcast and multicast messages. When the router has buffered broadcast or multicast messages for associated clients, it sends the next DTIM with a DTIM Interval value. You can specify the value between 1-255 Beacon Intervals. The default value is 1, which indicates the DTIM Interval is the same as Beacon Interval.
- **Group Key Update Period** - Enter a number of seconds (minimum 30) to control the time interval for the encryption key automatic renewal. The default value is 0, meaning no key renewal.

4. 4. NAT Forwarding

The router's NAT (Network Address Translation) feature makes the devices on the LAN use the same public IP address to communicate on the internet, which protects the local network by hiding IP addresses of the devices. However, it also brings about the problem that external hosts cannot initiatively communicate with the specified devices in the local network.

With the forwarding feature, the router can traverse the isolation of NAT so that clients on the internet can reach devices on the LAN and realize some specific functions.

The Mercusys router includes four forwarding rules. If two or more rules are set, the priority of implementation from high to low is Port Forwarding, Port Triggering, UPNP and DMZ.

4. 4. 1. Port Forwarding

When you build up a server in the local network and want to share it on the internet, Port Forwarding can realize the service and provide it to internet users. At the same time Port

Forwarding can keep the local network safe as other services are still invisible from the internet.

Port Forwarding can be used to set up public services in your local network, such as HTTP, FTP, DNS, POP3/SMTP and Telnet. Different service uses different service port. Port 80 is used in HTTP service, port 21 in FTP service, port 25 in SMTP service and port 110 in POP3 service. Please verify the service port number before the configuration.

I want to:

Share my personal website I've built in local network with my friends through the internet.

For example, the personal website has been built in my home PC (192.168.1.100). I hope that my friends on the internet can visit my website in some way. My PC is connected to the router with the WAN IP address 218.18.232.154.

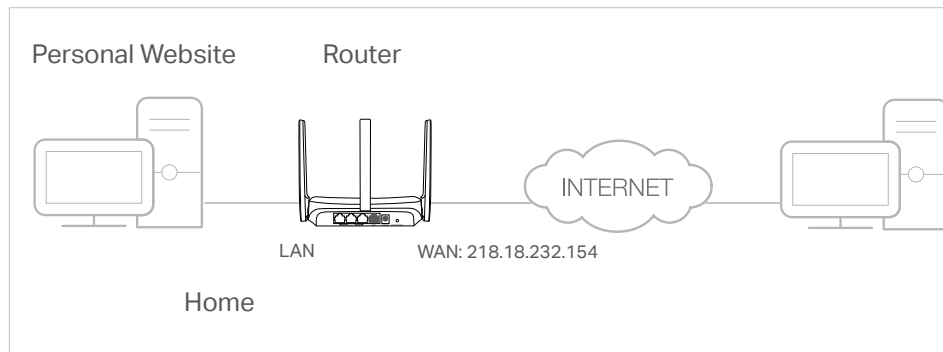

1. Set your PC to a static IP address, for example 192.168.1.100.
2. Visit <http://mwlogin.net>, and log in with the password you set for the router.
3. Go to **Advanced > NAT Forwarding > Port Forwarding**.
4. Click **Add**.

5. Click **VIEW COMMON SERVICES** and select **HTTP**. The **External Port**, **Internal Port** and **Protocol** will be automatically filled in.
6. Click **VIEW CONNECTED DEVICES** and select your home PC. The **Device IP Address** will be automatically filled in. Or enter the PC's IP address 192.168.1.100 manually in the **Device IP Address** field.
7. Click **SAVE**.

Note:

- It is recommended to keep the default settings of **Internal Port** and **Protocol** if you are not clear about which port and protocol to use.
- If the service you want to use is not in the **Common Services** list, you can enter the corresponding parameters manually. You should verify the port number that the service needs.
- You can add multiple virtual server rules if you want to provide several services in a router. Please note that the **External Port** should not be overlapped.

Done!

Users on the internet can enter **http:// WAN IP** (in this example: **http:// 218.18.232.154**) to visit your personal website.

Note:

- If you have changed the default **External Port**, you should use **http:// WAN IP: External Port** to visit the website.
- The WAN IP should be a public IP address. For the WAN IP is assigned dynamically by the ISP, it is recommended to apply and register a domain name for the WAN referring to **Dynamic DNS**. Then users on the internet can use **http:// domain name** to visit the website.

4.4.2. Port Triggering

Port triggering can specify a triggering port and its corresponding external ports. When a host in the local network initiates a connection to the triggering port, all the external ports will be opened for subsequent connections. The router can record the IP address of the

host. When the data from the internet return to the external ports, the router can forward them to the corresponding host. Port triggering is mainly applied to online games, VoIPs, video players and common applications including MSN Gaming Zone, Dialpad, Quick Time 4 players and more.

Follow the steps below to configure the port triggering rules:

1. Visit <http://mwlogin.net>, and log in with the password you set for the router.
2. Go to **Advanced > NAT Forwarding > Port Triggering**.
3. Click **Add**.
4. Click **VIEW COMMON SERVICES**, and select the desired application. The Triggering Port, Triggering Protocol and External Port will be automatically filled in. The following picture takes application MSN Gaming Zone as an example.

The screenshot shows a dialog box titled "Add a Port Triggering Entry" with a close button (X) in the top right corner. The dialog contains the following fields and controls:

- Service Name:** A text input field containing "MSN Gaming Zone".
- VIEW COMMON SERVICES:** A red button located below the Service Name field.
- Triggering Port:** A text input field containing "47624".
- Triggering Protocol:** A dropdown menu with "All" selected and a downward arrow.
- External Port:** A text input field containing "2300-2400,28800-29000". Below this field is a note: "(XX or XX-XX, 1-65535, at most 5 pairs)".
- External Protocol:** A dropdown menu with "All" selected and a downward arrow.
- Enable This Entry:** A checkbox that is checked, located below the External Protocol field.
- CANCEL:** A white button with a red border at the bottom left.
- SAVE:** A red button at the bottom right.

5. Click **SAVE**.

Note:

- You can add multiple port triggering rules as needed.
- The triggering ports can not be overlapped.
- If the application you need is not listed in the Common Services list, please enter the parameters manually. You should verify the external ports the application uses first and enter them in External Ports field. You can input at most 5 groups of ports (or port sections). Every group of ports must be set apart with ",". For example, 2000-2038, 2050-2051, 2085, 3010-3030.

4.4.3. UPnP

The UPnP (Universal Plug and Play) protocol allows the applications or host devices to automatically find the front-end NAT device and send request to it to open the corresponding ports. With UPnP enabled, the applications or host devices on the local network and the internet can freely communicate with each other realizing the seamless

connection of the network. You may need to enable the UPnP if you want to use applications for multiplayer gaming, peer-to-peer connections, real-time communication (such as VoIP or telephone conference) or remote assistance, etc.

Tips:

- UPnP is enabled by default in this router.
- Only the application supporting UPnP protocol can use this feature.
- UPnP feature needs the support of operating system (e.g. Windows Vista/ Windows 7/ Windows 8, etc. Some of operating system need to install the UPnP components).

For example, when you connect your Xbox to the router which is connected to the internet to play online games, UPnP will send request to the router to open the corresponding ports allowing the following data penetrating the NAT to transmit. Therefore, you can play Xbox online games without a hitch.

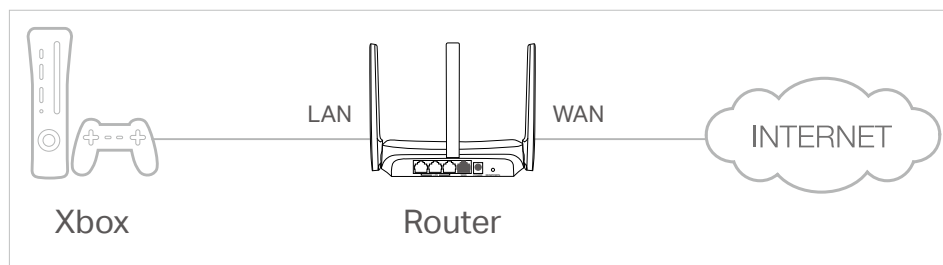

If necessary, you can follow the steps to change the status of UPnP.

1. Visit <http://mwlogin.net>, and log in with the password you set for the router.
2. Go to **Advanced > NAT Forwarding > UPnP** and toggle on or off according to your needs.

UPnP

Enable UPnP (Universal Plug and Play) to allow devices on your local network to dynamically open ports for applications such as multiplayer gaming and real-time communications.

UPnP:

UPnP Client List

Displays the UPnP device information.

Total Clients: 2 Refresh

Service Description	Client IP Address	Internal Port	External Port	Protocol
sk	192.168.0.14	20	10	TCP
gnss	1.1.1.1	70	20	UDP

4.4.4. DMZ

When a PC is set to be a DMZ (Demilitarized Zone) host in the local network, it is totally exposed to the internet, which can realize the unlimited bidirectional communication between internal hosts and external hosts. The DMZ host becomes a virtual server with all ports opened. When you are not clear about which ports to open in some special applications, such as IP camera and database software, you can set the PC to be a DMZ host.

Note:

DMZ is more applicable in the situation that users are not clear about which ports to open. When it is enabled, the DMZ host is totally exposed to the internet, which may bring some potential safety hazards. If DMZ is not in use, please disable it in time.

I want to:

Make the home PC join the internet online game without port restriction.

For example, due to some port restriction, when playing the online games, you can log in normally but cannot join a team with other players. To solve this problem, set your PC as a DMZ host with all ports opened.

How can I do that?

1. Assign a static IP address to your PC, for example 192.168.1.100.
2. Visit <http://mwlogin.net>, and log in with the password you set for the router.
3. Go to **Advanced > NAT Forwarding > DMZ** and select **Enable DMZ**.
4. Click **VIEW CONNECTED DEVICES** and select your PC. The DMZ Host IP Address will be automatically filled in. Or enter the PC's IP address 192.168.1.100 manually in the DMZ Host IP Address field.

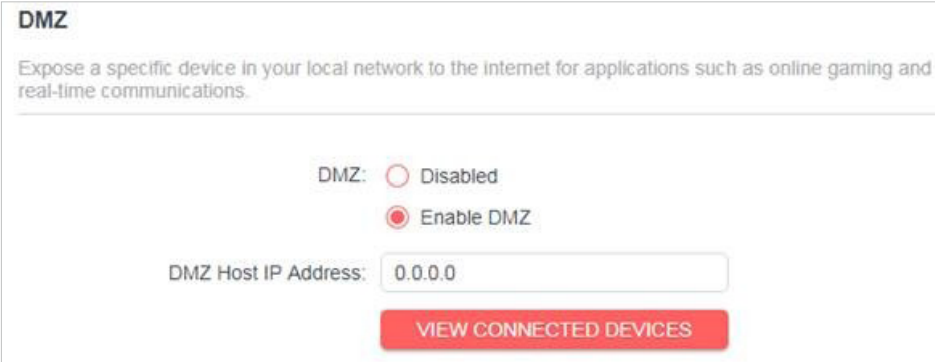

DMZ

Expose a specific device in your local network to the internet for applications such as online gaming and real-time communications.

DMZ: Disabled
 Enable DMZ

DMZ Host IP Address:

VIEW CONNECTED DEVICES

5. Click **SAVE**.

Done!

You've set your PC to a DMZ host and now you can make a team to game with other players.

4.5. Parental Controls

Parental Controls allows you to set up unique restrictions on internet access for each member of your family. You can block inappropriate content, set daily limits for the total time spent online and restrict internet access to certain times of the day.

I want to:

Block access to inappropriate online content for my child's devices, restrict internet access to 2 hours every day and block internet access during bed time (10 PM to 7 AM) on weekdays.

How can I do that?

1. Visit <http://mwlogin.net>, and log in with the password you set for the router.
2. Go to **Advanced > Parental Controls**.
3. Click **Add** to create a profile for a family member.

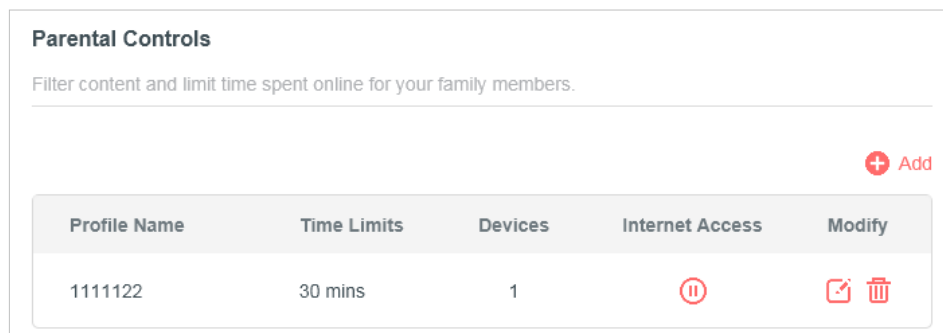

4. Add basic profile information.

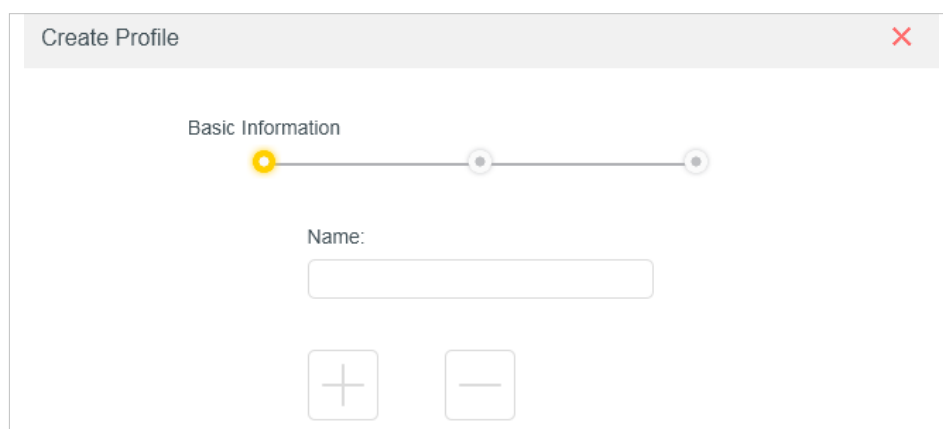

- 1) Enter a Name for the profile to make it easier to identify.
- 2) Under Devices, click .
- 3) Select the devices that belong to this family member. Access restrictions will be applied to these devices. Click **ADD** when finished.

Note: Only devices that have previously been connected to your router's network are listed here. If you are unable to find the device you want to add, connect it to your network and then try again.

4) Click **NEXT**.

5. Block content for this profile.

The screenshot shows the 'Create Profile' wizard with the 'Blocked Content' step selected. A progress bar at the top has three yellow circles, with the second one highlighted. Below the progress bar, the 'Blocked Content' section is active. It contains the text 'Blocked Content' and 'Block all websites that contain a specific keyword.' Below this is an input field labeled 'Input keyword' with a red plus sign to its right.

1) Enter the key word of the website that you want to block. Click **+** if want to block multiple websites.

2) Click **NEXT**.

6. Set time restrictions on internet access.

The screenshot shows the 'Create Profile' wizard with the 'Time Controls' step selected. A progress bar at the top has three yellow circles, with the third one highlighted. Below the progress bar, the 'Time Controls' section is active. It contains the text 'Time Controls' and 'Set daily time limits for the total time spent online.' Below this are two sections: 'Time Limits' and 'Bed Time'.
 In the 'Time Limits' section, there are two rows. The first row is for 'Mon to Fri' with a red toggle switch and a 'Daily Time Limit' dropdown set to '2 hours'. The second row is for 'Sat & Sun' with a red toggle switch and a 'Daily Time Limit' dropdown set to '2 hours'.
 In the 'Bed Time' section, there are three rows. The first row is for 'School Nights: (Sun to Thur)' with a red toggle switch, a 'Good Night' dropdown set to '22', and a time dropdown set to '00'. The second row is for 'Good Morning' with a dropdown set to '07' and a time dropdown set to '00'. The third row is for 'Weekend: (Fri & Sat)' with a white toggle switch.

- 1) Enable **Time Limits** on Monday to Friday and Saturday & Sunday then set the allowed online time to 2 hours each day.
- 2) Enable **Bed Time** on School Nights (Sun to Thur) and use the up/down arrows or enter times in the fields. Devices under this profile will be unable to access the internet during this time period.
- 3) Click **SAVE**.

Note: The effective time limits are based on the time of the router. You can go to **Advanced > System > Time** to modify the time.

Done!

The amount of time your child spends online is controlled and inappropriate content is blocked on their devices.

4.6. QoS

QoS (Quality of Service) is designed to ensure the efficient operation of the network when come across network overload or congestion. Devices set as high priority will be allocated more bandwidth and so continue to run smoothly even when there are many devices connected to the network.

I want to:

Ensure a fast connection of my computer while I play online games for the next 2 hours.

How can I do that

1. Visit <http://mwlogin.net>, and log in with the password you set for the router.
2. Go to **Advanced > QoS**.
3. Tick the **Enable** checkbox of QoS.
4. Enter the maximum upload and download bandwidths provided by your internet service provider, and then click **SAVE**. 1Mbps equals to 1,000Kbps.
5. Find your computer in the **Device Priority** section and toggle on **Priority**. Select 4 hours from the drop-down list of **Timing**. Your computer will be prioritized for the next 4 hours.

Global Settings

Prioritize the internet traffic of specific devices to guarantee a faster connection. You need to set the total bandwidth before using QoS.

QoS: Enable

Upload Bandwidth: Kbps ▼

Download Bandwidth: Kbps ▼

Device Priority

Type	Information	Real-time Rate	Traffic Usage	Priority	Timing
+		↑ 2.0 KB/s		-	4 hours ▼

Done!

You can now enjoy playing games without lag on your computer for the next 4 hours.

4.7. Security

This function allows you to protect your home network from cyber attacks and unauthorized users by implementing these network security functions.

4.7.1. Firewall

The SPI (Stateful Packet Inspection) Firewall protects the router from cyber attacks and validate the traffic that is passing through the router based on the protocol. This function is enabled by default.

1. Visit <http://mwlogin.net>, and log in with the password you set for the router.
2. Go to **Advanced > Security > Firewall**, and configure the parameters as you need. It's recommended to keep the default settings.

4.7.2. Access Control

Access Control is used to block or allow specific client devices to access your network (via wired or wireless) based on a list of blocked devices (Blacklist) or a list of allowed devices (Whitelist).

I want to:

Block or allow specific client devices to access my network (via wired or wireless).

How can I do that?

1. Visit <http://mwlogin.net>, and log in with the password you set for the router.
2. Go to **Advanced > Security > Access Control**.
3. Select the access mode to either block (recommended) or allow the device(s) in the list.

To block specific device(s):

- 1) Select **Blacklist** and click **SAVE**.

Access Control

Control the access to your network from the specified devices.

Access Control:





Access Mode: Blacklist
 Configure a blacklist to only block access to your network from the specified devices.

Whitelist

[+ Add](#)

- 2) Click **Add** and select devices you want to be blocked. You can see the devices have been added to the blacklist.

[+ Add](#)

Device Type	Device Name	MAC Address	Modify
	192.168.1.100	00-11-22-33-44-55	
	192.168.1.101	70-47-E9-E7-22-44	

To allow specific device(s):

- 1) Select **Whitelist** and click **SAVE**.

Access Control

Control the access to your network from the specified devices.

Access Control:

Access Mode: Blacklist
 Whitelist
 Configure a whitelist to only allow access to your network from the specified devices.

[+ Add](#)

- 2) Add devices to the whitelist.

- **Add connected devices**

Click **Select From Device List** and select the devices you want to be allowed.

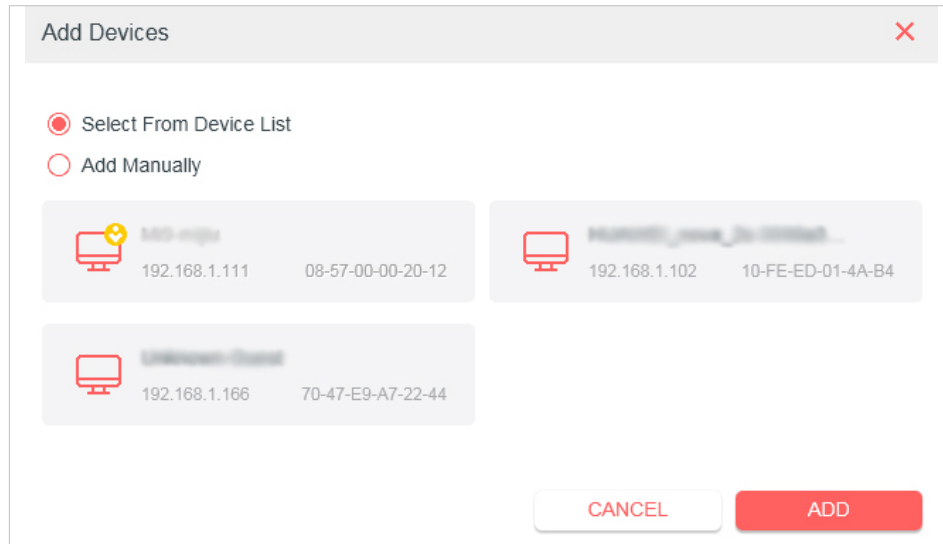

- **Add unconnected devices**

Click **Add Manually** and enter the **Device Name** and **MAC Address** of the device you want to be allowed.

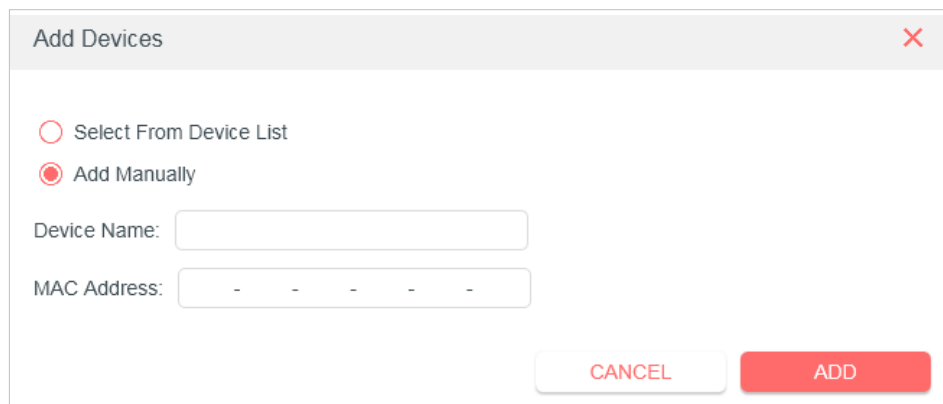

Done!

Now you can block or allow specific client devices to access your network (via wired or wireless) using the **Blacklist** or **Whitelist**.

4.7.3. IP & MAC Binding

IP & MAC Binding, namely, ARP (Address Resolution Protocol) Binding, is used to bind network device's IP address to its MAC address. This will prevent ARP Spoofing and other ARP attacks by denying network access to a device with matching IP address in the Binding list, but unrecognized MAC address.

I want to:

Prevent ARP spoofing and ARP attacks.

How can I do that?

1. Visit <http://mwlogin.net>, and log in with the password you set for the router.
2. Go to **Advanced > Security > IP & MAC Binding**.
3. Enable **IP & MAC Binding** and click **SAVE**.

IP & MAC Binding

Bind the MAC and IP addresses of devices to prevent ARP spoofing and attacks.

IP & MAC Binding:

4. Bind your device(s) according to your need.

To bind the connected device(s):

Locate the **ARP List** section and enable Bind to bind the IP and MAC addresses of a specific device.

ARP List

Bind or unbind the MAC and IP addresses of currently connected devices.

 Refresh

Device Name	MAC Address	IP Address	Bind	Modify
Unknown	08-57-00-00-20-12	192.168.1.111	<input checked="" type="checkbox"/>	
Unknown2	08-57-00-00-20-13	192.168.1.114	<input type="checkbox"/>	

To add a binding entry:

- 1) Click **Add** in the **Binding List** section.
- 2) Click **VIEW CONNECTED DEVICES** and select the device you want to bind. Or enter the **MAC Address** and **IP Address** that you want to bind.
- 3) Click **ADD**.

Add Binding Entry ✕

MAC Address:

IP Address:

4.8. ALG

You can view ALG (Application Layer Gateway) settings at **Advanced > Security > ALG**. It is recommended to keep them as default.

4.9. IPv6

This function allows you to enable IPv6 function and set up the parameters of the router's Wide Area Network (WAN) and Local Area Network (LAN).

1. Visit <http://mwlogin.net>, and log in with the password you set for the router.
2. Go to **Advanced > IPv6**, and you can view the current IPv6 status information of the router.
3. Enable **IPv6** and select the mode: **Router** or **Pass-Through (Bridge)**.

- **If you select Router:**

IPv6

Set up an IPv6 connection if your ISP provides IPv6 service.

Mode: Router ▼

Fill in WAN and LAN information as required by different connection types.

- **Normal:** The default connection type.
 - 1) Configure the WAN settings.

WAN

Configure the WAN connection based on your network typology.

WAN Connection Type: Normal ▼

Get IPv6 Address: Auto ▼

Manually set DNS server

Link-Local Address:

Global Address:

Gateway:

Primary DNS:

Secondary DNS:

2) Configure the LAN settings. Fill in **Address Prefix** provided by your ISP.

LAN

Configure the LAN IPv6 address of the router.

Enable Prefix Delegation

Address Prefix:

Prefix Length:

Link-Local Address:

Prefix:

3) Click **SAVE**.

- **PPPoE**: Select this type if your ISP uses PPPoEv6, and provides a username and password.

1) Configure the WAN settings.

WAN

Configure the WAN connection based on your network typology.

WAN Connection Type:

Get IPv6 Address:

Use the same PPPoE session as IPv4 

Username:

Password:

Manually set DNS server

Link-Local Address:

Global Address:

Gateway:

Primary DNS:

Secondary DNS:

2) Configure the LAN settings. Fill in Address Prefix provided by your ISP.

LAN

Configure the LAN IPv6 address of the router.

Enable Prefix Delegation

Address Prefix:

Prefix Length:

Link-Local Address:

Prefix:

- **Tunnel 6to4:** Select this type if your ISP uses 6 to 4 deployment for assigning address.

1) Configure the WAN settings.

WAN

Configure the WAN connection based on your network typology.

WAN Connection Type:

Manually set DNS server

Link-Local Address:

Global Address:

Gateway:

Primary DNS:

Secondary DNS:

2) Configure the LAN settings.

- **If you select Pass-Through (Bridge):**

Click **SAVE**. No configuration is required.

IPv6

Set up an IPv6 connection if your ISP provides IPv6 service.

Mode:

Select this type if your ISP uses Pass-Through (Bridge) network deployment.

4. 10. System

4. 10. 1. Firmware Upgrade

Mercusys is dedicated to improving and enriching the product features, giving users a better network experience. We will release the latest firmware at Mercusys official website www.mercusys.com. You can download the latest firmware file from the Support page of our website and upgrade the firmware to the latest version.

1. Download the latest firmware file for the router from our website www.mercusys.com.
2. Visit <http://mwlogin.net>, and log in with the password you set for the router.
3. Go to **Advanced > System > Firmware Upgrade**.
4. Click **BROWSE** to locate the downloaded firmware file, and click **UPGRADE**.

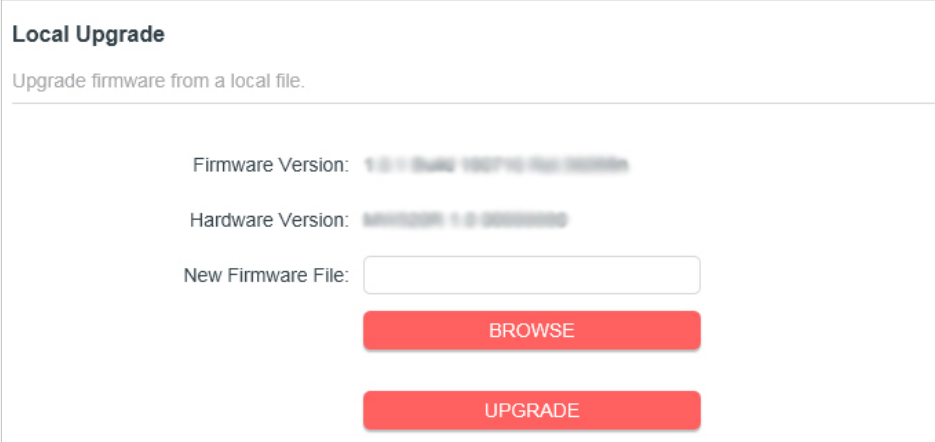

The screenshot shows the 'Local Upgrade' section of the router's web interface. It includes the title 'Local Upgrade', a subtitle 'Upgrade firmware from a local file.', and two lines of status information: 'Firmware Version: 1.0.1 Build 100710-100000' and 'Hardware Version: M5350V1 1.0 000000'. Below this is a text input field labeled 'New Firmware File:' with a red 'BROWSE' button underneath it. At the bottom of the section is a red 'UPGRADE' button.

4. 10. 2. Backup & Restore

The configuration settings are stored as a configuration file in the router. You can backup the configuration file in your computer for future use and restore the router to the previous settings from the backup file when needed.

1. Visit <http://mwlogin.net>, and log in with the password you set for the router.
2. Go to **Advanced > System > Backup & Restore**.

To backup configuration settings:

Click **BACK UP** to save a copy of the current settings in your local computer. A ".bin" file of the current settings will be stored in your computer.

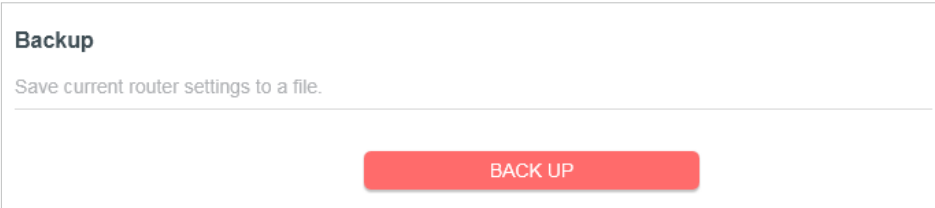

The screenshot shows the 'Backup' section of the router's web interface. It includes the title 'Backup' and the subtitle 'Save current router settings to a file.'. At the bottom of the section is a red 'BACK UP' button.

To restore configuration settings:

1. Click **BROWSE** to locate the backup configuration file stored in your computer, and click **RESTORE**.
2. Wait a few minutes for the restoring and rebooting.

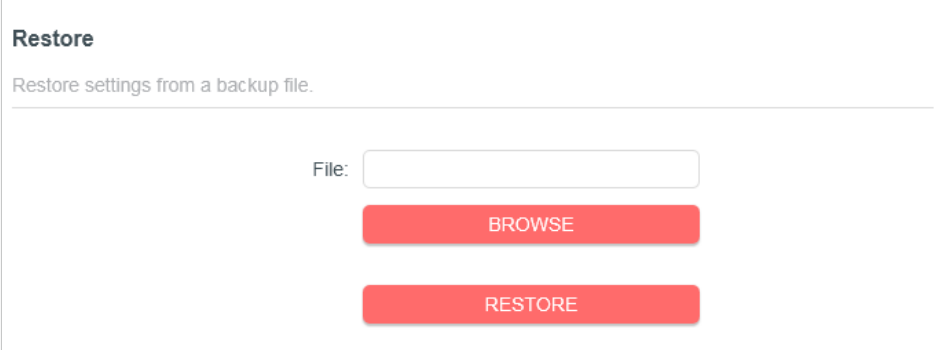

Restore
Restore settings from a backup file.

File:

BROWSE

RESTORE

To reset the router to factory default settings:

1. Click **FACTORY RESTORE** to reset the router.

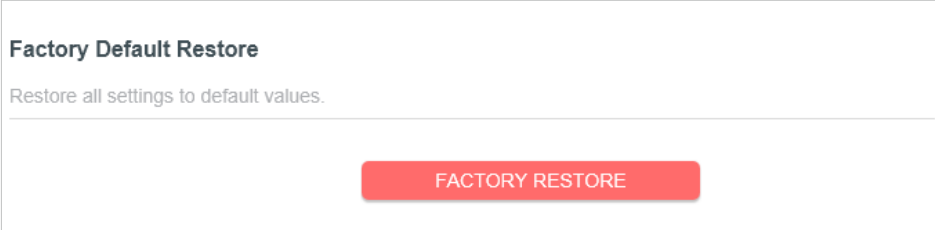

Factory Default Restore
Restore all settings to default values.

FACTORY RESTORE

2. Wait a few minutes for the restoring and rebooting.

Note:

- During the resetting process, do not turn off or reset the router.
- We strongly recommend you back up the current configuration settings before resetting the router.

4. 10. 3. Change Password

1. Visit <http://mwlogin.net>, and log in with the password you set for the router.
2. Go to **Advanced > System > Administration**, and focus on the Change Password section.

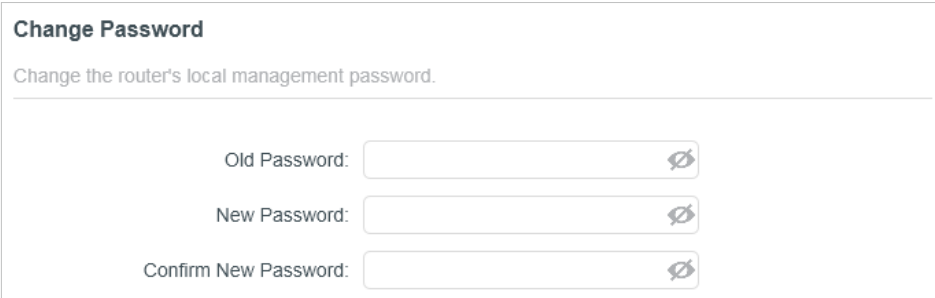

Change Password
Change the router's local management password.

Old Password:

New Password:

Confirm New Password:

3. Enter the old password, then a new password twice (both case-sensitive). Click **SAVE**.
4. Use the new password for future logins.

4. 10. 4. Local Management

1. Visit <http://mwlogin.net>, and log in with the password you set for the router.
2. Go to **Advanced > System > Administration**, and focus on the Local Management section.

- **Allow all LAN connected devices to manage the router:**

Select **All Devices** for Local Managers.

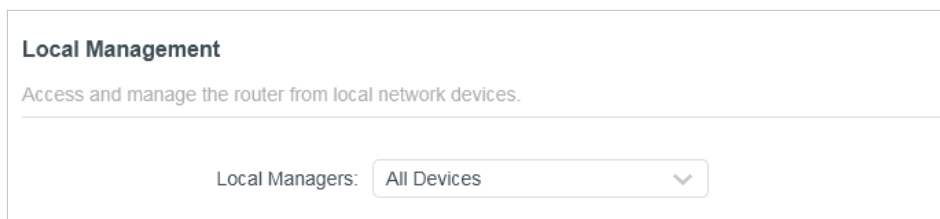

The screenshot shows the 'Local Management' section of a router's configuration interface. The title is 'Local Management' with a subtitle 'Access and manage the router from local network devices.' Below this, there is a dropdown menu labeled 'Local Managers:' which is currently set to 'All Devices'.

- **Allow specific devices to manage the router:**

1. Select **Specified Devices** for Local Managers and click **SAVE**.

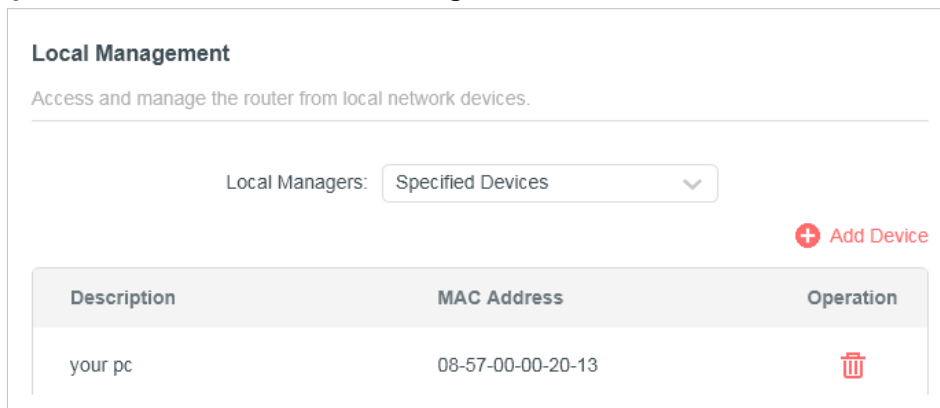

The screenshot shows the 'Local Management' section with the 'Local Managers:' dropdown set to 'Specified Devices'. To the right of the dropdown is a red '+ Add Device' button. Below this is a table with three columns: 'Description', 'MAC Address', and 'Operation'. The table contains one entry: 'your pc' with MAC address '08-57-00-00-20-13' and a red trash icon in the 'Operation' column.

Description	MAC Address	Operation
your pc	08-57-00-00-20-13	

2. Click **Add Device**.

3. Click **VIEW CONNECTED DEVICES** and select the device to manage the router from the Connected Devices list, or enter the **MAC address** of the device manually.
4. Specify a **Description** for this entry.
5. Click **SAVE**.

4. 10. 5. Remote Management

1. Visit <http://mwlogin.net>, and log in with the password you set for the router.
2. Go to **Advanced > System > Administration**, and focus on the Remote Management section.

- **Forbid all devices to manage the router remotely:**

Do not tick the **Enable** checkbox of **Remote Management**.

- **Allow all devices to manage the router remotely:**

1. Tick the **Enable** checkbox of **Remote Management**.
2. Keep the HTTP port as default setting (recommended) or enter a value between 1024 and 65535.
3. Select **All Devices** for **Remote Managers**.
4. Click **SAVE**.

Devices on the internet can log in to **http://Router's WAN IP address:port number** (such as **http://113.116.60.229:1024**) to manage the router.

Tips:

- You can find the WAN IP address of the router on **Network Map > Internet**.
- The router's WAN IP is usually a dynamic IP. Please refer to **Dynamic DNS** if you want to log in to the router through a domain name.
- **Allow a specific device to manage the router remotely:**

Remote Management

Access and manage the router over the internet.

Note: Remote Management is not supported when you are connected to the internet only via IPv6. If you want to use Remote Management, please make sure you have set up an IPv4 connection first.

Remote Management: Enable

HTTP Port:

Web Address for Management: 2.2.2.2

Remote Managers: ▼

Only this IP Address:

1. Tick the **Enable** checkbox of **Remote Management**.
2. Keep the HTTP port as default setting (recommended) or enter a value between 1024 and 65535.
3. Select **Specified Device** for **Remote Managers**.
4. In the Only this IP Address field, enter the IP address of the remote device to manage the router.
5. Click **SAVE**.

Devices using this WAN IP can manage the router by logging in to **http://Router's WAN IP:port number** (such as **http://113.116.60.229:1024**).

Tips: The router's WAN IP is usually a dynamic IP. Please refer to **Dynamic DNS** if you want to log in to the router through a domain name.

4. 10. 6. System Log

1. Visit **http://mwlogin.net**, and log in with the password you set for the router.

2. Go to **Advanced > System > System Log**, and you can view the logs of the router.

3. Click **SAVE TO LOCAL** to save the system logs to a local disk.

4. 10. 7. Diagnostics

Diagnostics is used to test the connectivity between the router and the host or other network devices.

1. Visit <http://mwlogin.net>, and log in with the password you set for the router.
2. Go to **Advanced > System > Diagnostics**.

3. Enter the information:

- 1) Choose **Ping** or **Tracert** as the diagnostic tool to test the connectivity.

- **Ping** is used to test the connectivity between the router and the tested host, and measure the round-trip time.
 - **Tracert** is used to display the route (path) your router has passed to reach the tested host, and measure transit delays of packets across an Internet Protocol network.
- 2) Enter the **IP Address** or **Domain Name** of the tested host.
 - 3) Modify the **Ping Count** number and the **Ping Packet Size**. It's recommended to keep the default value.
 - 4) If you have chosen **Tracert**, you can modify the **Traceroute Max TTL**. It's recommended to keep the default value.

4. Click **START** to begin the diagnostics.

The figure below indicates the proper connection between the router and the Yahoo server (www.Yahoo.com) tested through **Ping**.

```
Finding host yahoo.com by DNS server (1 of 2).
Pinging yahoo.com [98.138.219.231] with 64 bytes of data:
Reply from 98.138.219.231: bytes=64 time=233ms TTL=48 (seq=0).
Reply from 98.138.219.231: bytes=64 time=233ms TTL=48 (seq=1).
Reply from 98.138.219.231: bytes=64 time=233ms TTL=48 (seq=2).
Reply from 98.138.219.231: bytes=64 time=233ms TTL=48 (seq=3).
Ping statistics for 98.138.219.231:
Packets: Sent = 4, Received = 4, Lost = 0 (0% loss).
Approximate round trip times in milli-seconds:
Minimum = 233ms, Maximum = 233ms, Average = 233ms
```

The figure below indicates the proper connection between the router and the Yahoo server (www.Yahoo.com) tested through **Tracert**.

```
Finding host yahoo.com by DNS server (1 of 2).
Tracing route to yahoo.com [72.30.35.10]
over a maximum of 30 hops:
 0 1 ms 1 ms 1 ms 10.0.0.1
 1 1 ms 1 ms 1 ms 116.24.64.1
 2 1 ms 1 ms 1 ms 202.105.155.185
 3 1 ms 1 ms 1 ms 183.56.65.2
 4 * 1 ms * 202.97.94.150
 5 16 ms 16 ms 16 ms 202.97.94.94
 6 150 ms 150 ms 150 ms 202.97.27.242
 7 166 ms 166 ms 166 ms 202.97.50.74
 8 150 ms 150 ms 150 ms 4.53.210.145
```

4. 10. 8. Time

This function allows you to set the time manually or to configure automatic time synchronization. The router can automatically update the time from an NTP server via the internet.

1. Visit <http://mwlogin.net>, and log in with the password you set for the router.

2. Go to **Advanced > System > Time & Language**.

- **To set System Time:**

System Time

Set the router's system time.

Current Time: 2020-07-26 09:05:18

24-Hour Time:

Set Time:

Time Zone:

NTP Server I:

NTP Server II: (Optional)

1. In the **System Time** section, select the way in which the router gets its time: **Get from Internet, Get from Managing Device, Manually**.

2. Select your local **Time Zone**.

3. Enter the address or domain of the **NTP Server 1** or **NTP Server 2**.

4. Click **SAVE**.

- **To set up Daylight Saving Time:**

1. In the **Daylight Saving Time** section, tick the **Enable** box.

Daylight Saving Time

Automatically synchronize the system time with daylight saving time.

Daylight Saving Time: Enable

Start: 2020

End: 2020

Running Status: Daylight Saving Time is off.

2. Select the start time from the drop-down list in the **Start** fields.

3. Select the end time from the drop-down list in the **End** fields.

4. Click **SAVE**.

Note:

This setting will be used for some time-based functions such as firewall. You must specify your time zone once you log in to the router successfully; otherwise, time-based functions will not take effect.

4. 10. 9. Language

This function allows you to set the language for the system.

1. Visit <http://mwlogin.net>, and log in with the password you set for the router.
2. Go to **Advanced > System > Time & Language**.

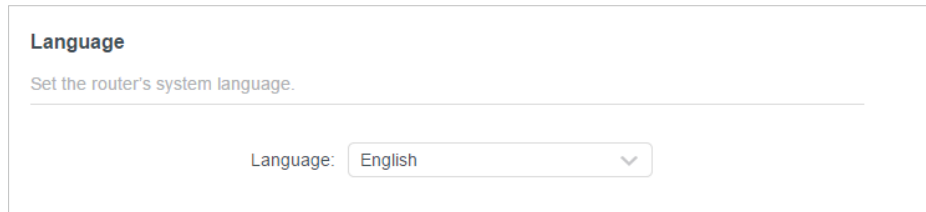

Language
Set the router's system language.

Language: English

3. In the **Language** section, choose your desired language.
4. Click **SAVE**.

4. 10. 10. Reboot

Some settings of the router will take effect only after rebooting, and the system will reboot automatically. You can also reboot the router to clear cache and enhance running performance.

1. Visit <http://mwlogin.net>, and log in with the password you set for the router.
2. Go to **Advanced > System > Reboot**, and you can restart your router.

- **To reboot the router manually:**

Click **REBOOT**, and wait a few minutes for the router to reboot.

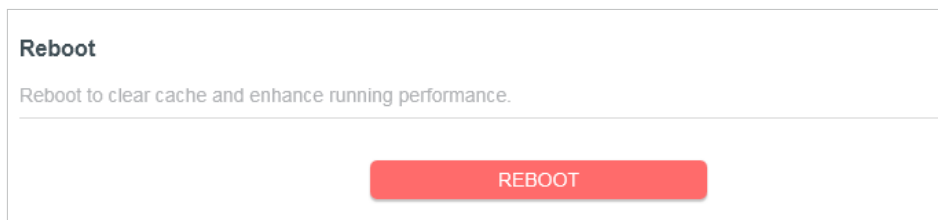

Reboot
Reboot to clear cache and enhance running performance.

REBOOT

- **To set the router to reboot regularly:**

1. Tick the **Enable** box of **Reboot Schedule**.
2. Specify the **Reboot Time** when the router reboots and **Repeat** to decide how often it reboots.
3. Click **SAVE**.

Reboot Schedule

Set when and how often the router reboots automatically.

Reboot Schedule: Enable

Note: Make sure **Time Settings** are correct before using this function.

Current Time: 2019-07-26 01:00:10

Reboot Time: 02 : 00

Repeat: Every Day

4. 10. 11. LED Control

The LED of the router indicates its activities and status. You can enable the **Night Mode** feature to specify a time period during which the LED is off.

1. Visit <http://mwlogin.net>, and log in with the password you set for the router.
2. Go to **Advanced > System > LED Control**.
3. Enable **Night Mode**.

LED Control

Turn the router's LEDs on or off.

LED Status:

Night Mode

Set a time period when the LEDs will be off automatically.

Night Mode: Enable

Note: Make sure **Time Settings** are correct before using this function.

Current Time: 2019-07-26 01:00:10

LED Off From: 23 : 00

To: 06 : 00 (next day)

4. Specify the LED off time, and the LED will be off during this period every day.

Note: The effective LED off time is based on the time of the router. You can go to **Advanced > System > Time** to modify the time.

5. Click **SAVE**.

Chapter 5. Configure the Router in Access Point Mode

This chapter presents how to configure the various features of the router working as an access point.

It contains the following sections:

- **Operation Mode**
- **Firmware Upgrade**
- **Backup & Restore**
- **Administration**
- **System Log**
- **Diagnostics**
- **Time**
- **Language**
- **Reboot**
- **LED Control**

5.1. Operation Mode

1. Visit <http://mwlogin.net>, and log in with the password you set for the router.
2. Go to **System > Operation Mode**.
3. Select the working mode as needed and click **SAVE**.

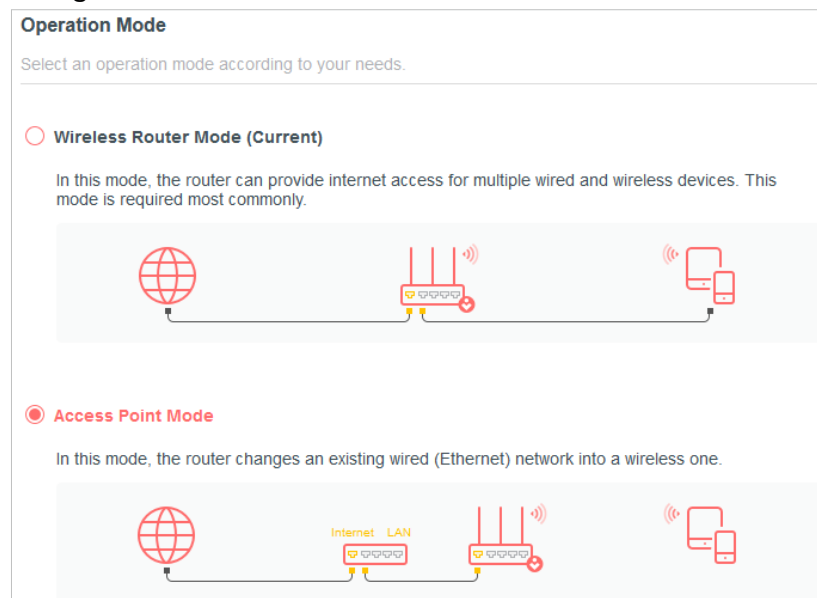

5.2. Firmware Upgrade

Mercusys is dedicated to improving and enriching the product features, giving users a better network experience. We will release the latest firmware at Mercusys official website www.mercusys.com. You can download the latest firmware file from the Support page of our website and upgrade the firmware to the latest version.

1. Download the latest firmware file for the router from our website www.mercusys.com.
2. Visit <http://mwlogin.net>, and log in with the password you set for the router.
3. Go to **System > Firmware Upgrade**.
4. Click **BROWSE** to locate the downloaded firmware file, and click **UPGRADE**.

Local Upgrade
Upgrade firmware from a local file.

Firmware Version: V1.1.1 (Build 100710) (RC 1000000)
Hardware Version: M7820N V1.0 (0000000)

New Firmware File:

BROWSE

UPGRADE

5.3. Backup & Restore

The configuration settings are stored as a configuration file in the router. You can backup the configuration file in your computer for future use and restore the router to the previous settings from the backup file when needed.

1. Visit <http://mwlogin.net>, and log in with the password you set for the router.
2. Go to **System > Backup & Restore**.

To backup configuration settings:

Click **BACK UP** to save a copy of the current settings in your local computer. A ".bin" file of the current settings will be stored in your computer.

Backup
Save current router settings to a file.

BACK UP

To restore configuration settings:

1. Click **BROWSE** to locate the backup configuration file stored in your computer, and click **RESTORE**.
2. Wait a few minutes for the restoring and rebooting.

Restore

Restore settings from a backup file.

File:

BROWSE

RESTORE

To reset the router to factory default settings:

1. Click **FACTORY RESTORE** to reset the router.

Factory Default Restore

Restore all settings to default values.

FACTORY RESTORE

2. Wait a few minutes for the restoring and rebooting.

Note:

- During the resetting process, do not turn off or reset the router.
- We strongly recommend you back up the current configuration settings before resetting the router.

5.4. Administration

5.4.1. Change Password

1. Visit <http://mwlogin.net>, and log in with the password you set for the router.
2. Go to **System > Administration**, and focus on the Change Password section.

Change Password

Change the router's local management password.

Old Password: 

New Password: 

Confirm New Password: 

3. Enter the old password, then a new password twice (both case-sensitive). Click **SAVE**.

4. Use the new password for future logins.

5. 4. 2. Local Management

1. Visit <http://mwlogin.net>, and log in with the password you set for the router.
2. Go to **System > Administration**, and focus on the Local Management section.

- **Allow all LAN connected devices to manage the router:**

Select **All Devices** for Local Managers.

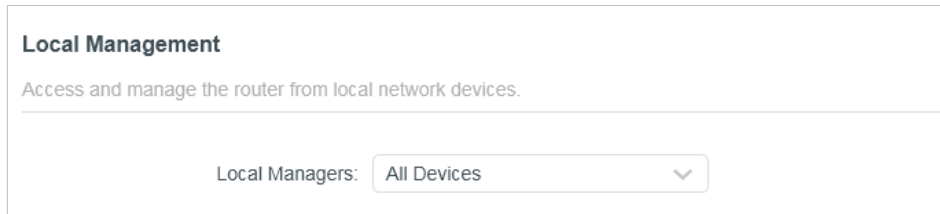

Local Management
Access and manage the router from local network devices.

Local Managers:

- **Allow specific devices to manage the router:**

1. Select **Specified Devices** for Local Managers and click **SAVE**.

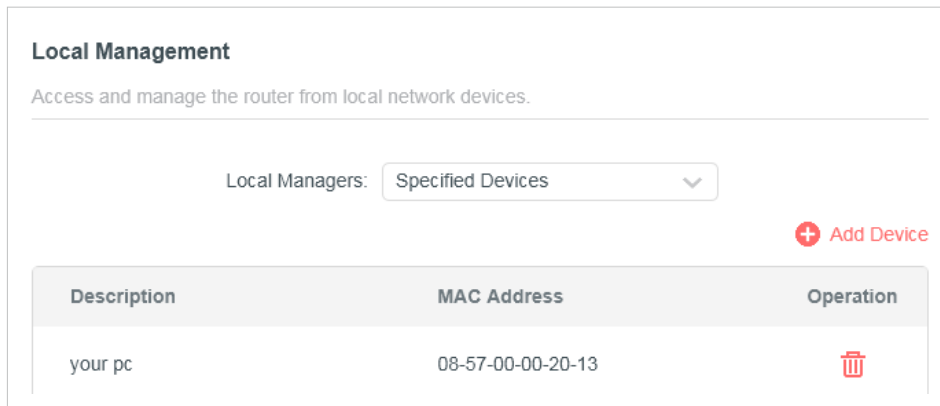

Local Management
Access and manage the router from local network devices.

Local Managers:

[+ Add Device](#)

Description	MAC Address	Operation
your pc	08-57-00-00-20-13	

2. Click **Add Device**.

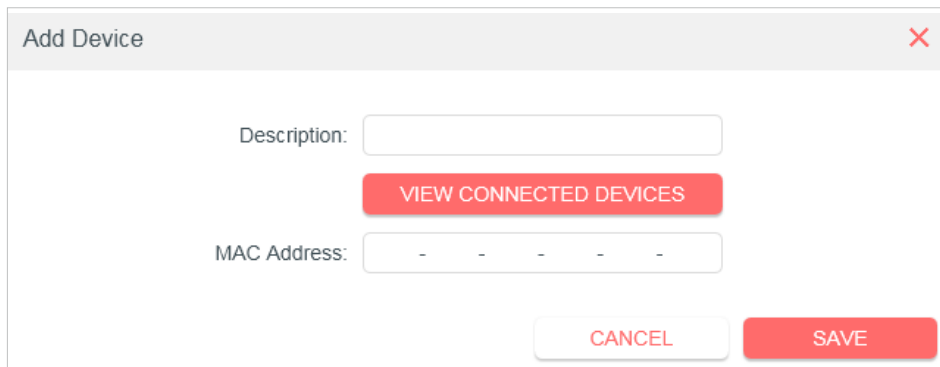

Add Device ✕

Description:

[VIEW CONNECTED DEVICES](#)

MAC Address:

[CANCEL](#) [SAVE](#)

3. Click **VIEW CONNECTED DEVICES** and select the device to manage the router from the Connected Devices list, or enter the **MAC address** of the device manually.
4. Specify a **Description** for this entry.
5. Click **SAVE**.

5.5. System Log

1. Visit <http://mwlogin.net>, and log in with the password you set for the router.
2. Go to **System > System Log**, and you can view the logs of the router.

System Log

View a detailed record of system activities.

Current Time: 2018-07-20 01:00:10

🔍
🔄 Refresh
🗑️ Clear All

```

1 EXCEPTION hello
2 EXCEPTION 1days, 02:03:04, 6

```

Save Log

Save system log locally.

SAVE TO LOCAL

3. Click **SAVE TO LOCAL** to save the system logs to a local disk.

5.6. Diagnostics

Diagnostic is used to test the connectivity between the router and the host or other network devices.

1. Visit <http://mwlogin.net>, and log in with the password you set for the router.
2. Go to **System > Diagnostics**.

Diagnostics

Troubleshoot network connectivity problems.

Diagnostic Tools: ▼

IP Address/Domain Name:

Ping Packet Number:

Ping Packet Size: Bytes

START

3. Enter the information:

- 1) Choose **Ping** or **Tracert** as the diagnostic tool to test the connectivity.
 - **Ping** is used to test the connectivity between the router and the tested host, and measure the round-trip time.
 - **Tracert** is used to display the route (path) your router has passed to reach the tested host, and measure transit delays of packets across an Internet Protocol network.
- 2) Enter the **IP Address** or **Domain Name** of the tested host.
- 3) Modify the **Ping Count** number and the **Ping Packet Size**. It's recommended to keep the default value.
- 4) If you have chosen **Tracert**, you can modify the **Traceroute Max TTL**. It's recommended to keep the default value.

4. Click **START** to begin the diagnostics.

The figure below indicates the proper connection between the router and the Yahoo server (www.Yahoo.com) tested through **Ping**.

```
Finding host yahoo.com by DNS server (1 of 2).
Pinging yahoo.com [98.138.219.231] with 64 bytes of data:
Reply from 98.138.219.231: bytes=64 time=233ms TTL=48 (seq=0).
Reply from 98.138.219.231: bytes=64 time=233ms TTL=48 (seq=1).
Reply from 98.138.219.231: bytes=64 time=233ms TTL=48 (seq=2).
Reply from 98.138.219.231: bytes=64 time=233ms TTL=48 (seq=3).
Ping statistics for 98.138.219.231:
Packets: Sent = 4, Received = 4, Lost = 0 (0% loss),
Approximate round trip times in milli-seconds:
Minimum = 233ms, Maximum = 233ms, Average = 233ms
```

The figure below indicates the proper connection between the router and the Yahoo server (www.Yahoo.com) tested through **Tracert**.

```
Finding host yahoo.com by DNS server (1 of 2).
Tracing route to yahoo.com [72.30.35.10]
over a maximum of 30 hops:
 0 1 ms 1 ms 1 ms 10.0.0.1
 1 1 ms 1 ms 1 ms 116.24.64.1
 2 1 ms 1 ms 1 ms 202.105.155.185
 3 1 ms 1 ms 1 ms 183.56.65.2
 4 * 1 ms * 202.97.94.150
 5 16 ms 16 ms 16 ms 202.97.94.94
 6 150 ms 150 ms 150 ms 202.97.27.242
 7 166 ms 166 ms 166 ms 202.97.50.74
 8 150 ms 150 ms 150 ms 4.53.210.145
```

5.7. Time

This function allows you to set the time manually or to configure automatic time synchronization. The router can automatically update the time from an NTP server via the internet.

1. Visit <http://mwlogin.net>, and log in with the password you set for the router.
2. Go to **System > Time & Language**.

- **To set System Time:**

System Time

Set the router's system time.

Current Time: 2020-07-26 09:00:10

24-Hour Time:

Set Time:

Time Zone:

NTP Server I:

NTP Server II: (Optional)

1. In the **System Time** section, select the way in which the router gets its time: **Get from Internet, Get from Managing Device, Manually**.
2. Select your local **Time Zone**.
3. Enter the address or domain of the **NTP Server 1** or **NTP Server 2**.
4. Click **SAVE**.

- **To set up Daylight Saving Time:**

1. In the **Daylight Saving Time** section, tick the **Enable** box.

Daylight Saving Time

Automatically synchronize the system time with daylight saving time.

Daylight Saving Time: Enable

Start: 2020

End: 2020

Running Status: Daylight Saving Time is off.

2. Select the start time from the drop-down list in the **Start** fields.
3. Select the end time from the drop-down list in the **End** fields.
4. Click **SAVE**.

Note:

This setting will be used for some time-based functions such as firewall. You must specify your time zone once you log in to the router successfully; otherwise, time-based functions will not take effect.

5.8. Reboot

Some settings of the router will take effect only after rebooting, and the system will reboot automatically. You can also reboot the router to clear cache and enhance running performance.

1. Visit <http://mwlogin.net>, and log in with the password you set for the router.
2. Go to **System > Reboot**, and you can restart your router.

- **To reboot the router manually:**

Click **REBOOT**, and wait a few minutes for the router to reboot.

Reboot

Reboot to clear cache and enhance running performance.

REBOOT

- **To set the router to reboot regularly:**

1. Tick the **Enable** box of **Reboot Schedule**.
2. Specify the **Reboot Time** when the router reboots and **Repeat** to decide how often it reboots.
3. Click **SAVE**.

Reboot Schedule

Set when and how often the router reboots automatically.

Reboot Schedule: Enable

Note: Make sure **Time Settings** are correct before using this function.

Current Time: 2018-07-26 01:00:00

Reboot Time: 02 : 00

Repeat: Every Day

5.9. LED Control

The LED of the router indicates its activities and status. You can enable the **Night Mode** feature to specify a time period during which the LED is off.

1. Visit <http://mwlogin.net>, and log in with the password you set for the router.
2. Go to **System > LED Control**.
3. Enable **Night Mode**.

LED Control

Turn the router's LEDs on or off.

LED Status:

Night Mode

Set a time period when the LEDs will be off automatically.

Night Mode: Enable

Note: Make sure **Time Settings** are correct before using this function.

Current Time: 2016-07-20 01:00:00

LED Off From: 23 : 00

To: 06 : 00 (next day)

4. Specify the LED off time, and the LED will be off during this period every day.

Note: The effective LED off time is based on the time of the router. You can go to **Advanced > System > Time** to modify the time.

5. Click **SAVE**.

Appendix A: FAQ (Frequently Asked Questions)

Q1. What can I do if the login window does not appear?

- Reboot your main router and try again.
- If the computer is set to a static IP address, change its settings to obtain an IP address automatically.
- Make sure you are accessing the web management through wireless connection.
- Verify that **http://mwlogin.net** is correctly entered in the web browser.
- Use another web browser and try again.
- Disable and enable the network adapter in use again.

Q2. What can I do if I cannot access the internet?

- Reboot your modem and main router, then try again.
- Check if the internet is working properly by connecting a computer directly to the modem via an Ethernet cable. If it is not, contact your internet service provider.
- Open a web browser, enter **http://mwlogin.net** and run the Quick Setup again.
- For cable modem users, reboot the modem first. If the problem still exists, log in to the web management page of the router to clone MAC address.

Q3. How do I restore the router to its factory default settings?

- With the router powered on, press and hold the **Reset** button on the router until there is an obvious change of the LEDs, and then release the button.
- Log in to the web management page and go to **Advanced > System tools > Factory Defaults** to restore the router to factory settings.

NOTE:

Once the modem router is reset, the current configuration settings will be lost and you will need to re-configure the router.

Q4. What can I do if I forgot my web management password?

Refer to FAQ >Q3 to reset the router, and then create a password for future logins.

Q5. What can I do if I forgot my wireless network password?

- By default, the wireless network has no password.
- If you have set a password for the wireless network, log in to the web management page of the router to retrieve or reset your password.

Appendix B: Configuring the PC

In this section, we'll introduce how to install and configure the TCP/IP correctly in Windows 7. First make sure your Ethernet Adapter is working, refer to the adapter's manual if needed.

1. Install TCP/IP component

- a. On the Windows taskbar, click **Start** button, and then click **Control Panel**.
- b. Click the **Network and Internet**, and click the **Network and Sharing Center**, then click **Change adapter settings**.
- c. Right click the icon that showed below, select **Properties** on the prompt page.

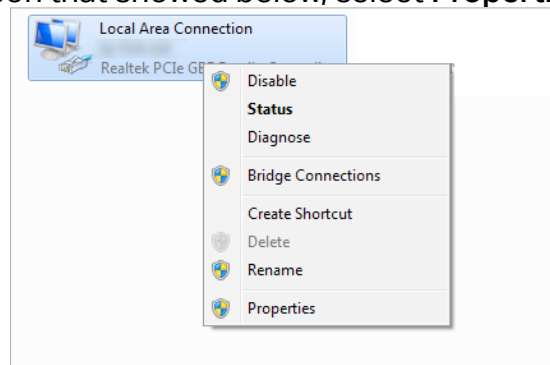

- d. In the prompt page that showed below, double click on the **Internet Protocol Version 4 (TCP/IPv4)**.

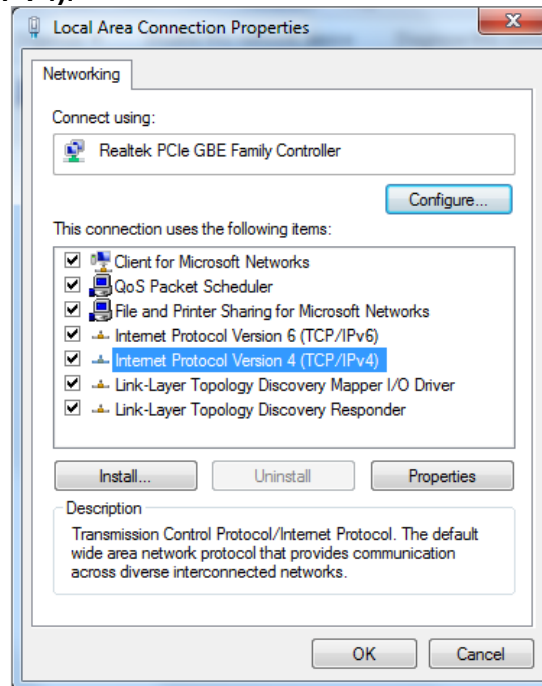

- e. The following **TCP/IP Properties** window will display and the **IP Address** tab is open on this window by default.

2. Configure the TCP/IP protocol

Now you have two ways to configure the **TCP/IP** protocol below:

- **Setting IP address automatically**

Select **Obtain an IP address automatically**, Choose **Obtain DNS server automatically**, as shown in the Figure below:

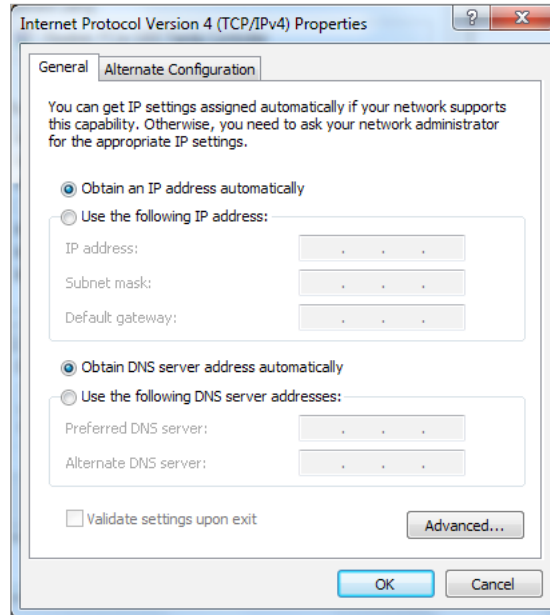

- **Setting IP address manually**

- a. Select **Use the following IP address** radio button. And the following items available.
- b. If the router's LAN IP address is 192.168.1.1, specify the IP address as 192.168.1.x (x is from 2 to 254), and **Subnet mask** is 255.255.255.0.
- c. Enter the router's LAN IP address (the default IP is 192.168.1.1) in the **Default gateway** field.
- d. Select **Use the following DNS server addresses** radio button. In the **Preferred DNS Server** field you can type the DNS server IP address, which has been provided by your ISP.

