

# Air Purifier

---

## User manual

AX60R5080WD / AX60T5080WF

---

- Thank you for purchasing this Samsung air purifier.
- Before operating this unit, please read this user manual carefully and retain it for future reference.

**SAMSUNG**

# Contents

---

<b>Package Content</b>	<b>3</b>
Accessories / Product specifications	3
<b>At a Glance</b>	<b>4</b>
At a Glance / General	4
Display and buttons	5
Removing the filter	6
Assembling the filter	7
<b>Operation Features</b>	<b>10</b>
Turning the power on/off / Controlling the fan speed	10
Sleep mode / Timed on/off function / Display lighting	11
Turning the Wi-Fi feature on/off / Clearing the filter replacement reminder / Lock function	12
Checking the air quality	13
<b>Cleaning and Maintenance</b>	<b>14</b>
Cleaning the air purifier exterior	14
Cleaning and drying the filter	15
<b>SmartThings app</b>	<b>16</b>
SmartThings app	16
<b>Appendix</b>	<b>20</b>
Before Requesting Service	20
Safety Precautions	23
Reference	28



## ***Correct Disposal of This Product (Waste Electrical & Electronic Equipment)***

### **(Applicable in countries with separate collection systems)**

This marking on the product, accessories or literature indicates that the product and its electronic accessories (e.g. charger, headset, USB cable) should not be disposed of with other household waste at the end of their working life. To prevent possible harm to the environment or human health from uncontrolled waste disposal, please separate these items from other types of waste and recycle them responsibly to promote the sustainable reuse of material resources.

Household users should contact either the retailer where they purchased this product, or their local government office, for details of where and how they can take these items for environmentally safe recycling. Business users should contact their supplier and check the terms and conditions of the purchase contract. This product and its electronic accessories should not be mixed with other commercial wastes for disposal.

For information on Samsung's environmental commitments and product-specific regulatory obligations, e.g. REACH, WEEE, Batteries, visit: [www.samsung.com/uk/aboutsamsung/sustainability/environment/our-commitment/data/](http://www.samsung.com/uk/aboutsamsung/sustainability/environment/our-commitment/data/)

# Package Content

## Accessories

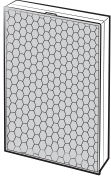

2-in-1 filter 1EA  
(Deodorization Filter+Dust  
Collecting Filter)

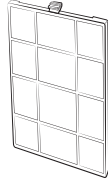

Pre-filter  
1 EA

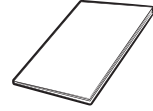

User manual 1 EA

## Product specifications

The product dimensions are based on the maximum dimensions. They may vary depending on the measurement position.

The product design and specifications are subject to change without prior notice for quality improvement.

Model name	Dimensions (width × height × depth)	Area coverage
AX60R5080WD / AX60T5080WF	360 mm x 783 mm x 293 mm	60 m <sup>2</sup>

# At a Glance

## General

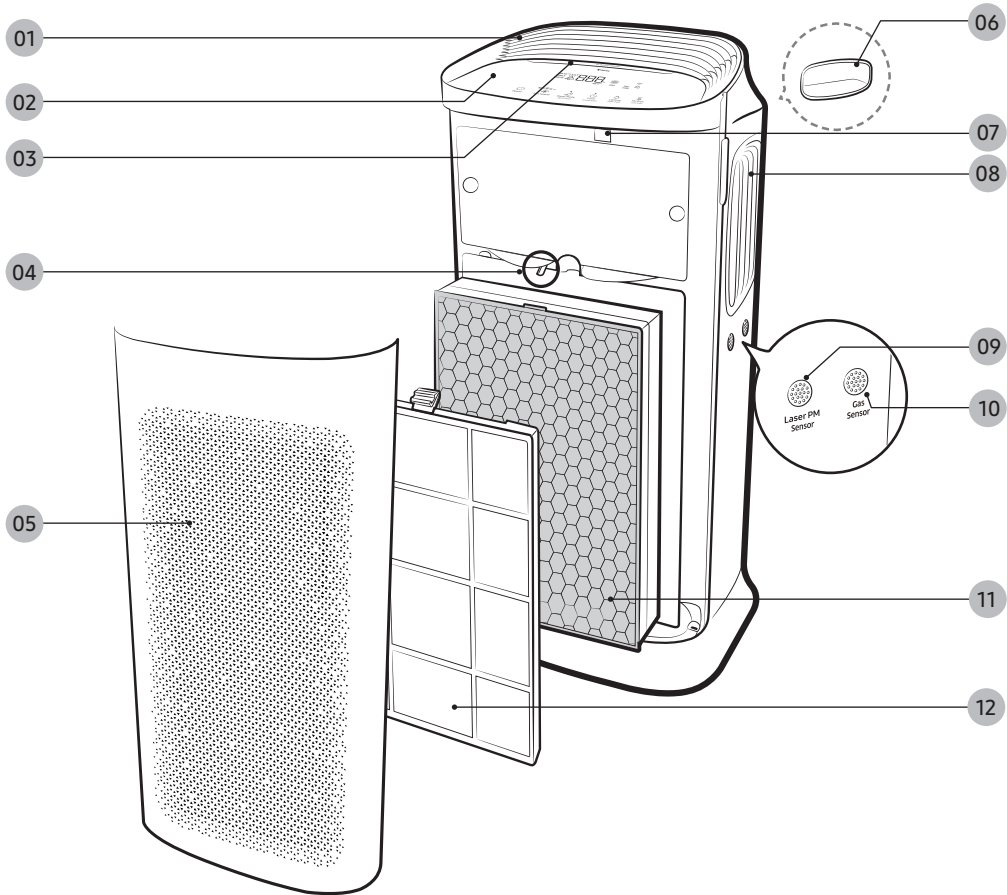

**01** Air outlet (top)

**02** Display and buttons

**03** Display lighting

**04** Filter holder

**05** Air inlet / Front panel

**06** Handle (rear side)

**07** Dongle mount

- This model is provided with integrated Wi-Fi connectivity and does not require an external dongle to use this function.

**08** Air outlet (side)

**09** Laser PM sensor

**10** Gas sensor

**11** 2-in-1 filter (Deodorization Filter + Dust Collecting Filter)

**12** Pre-filter

## Display and buttons

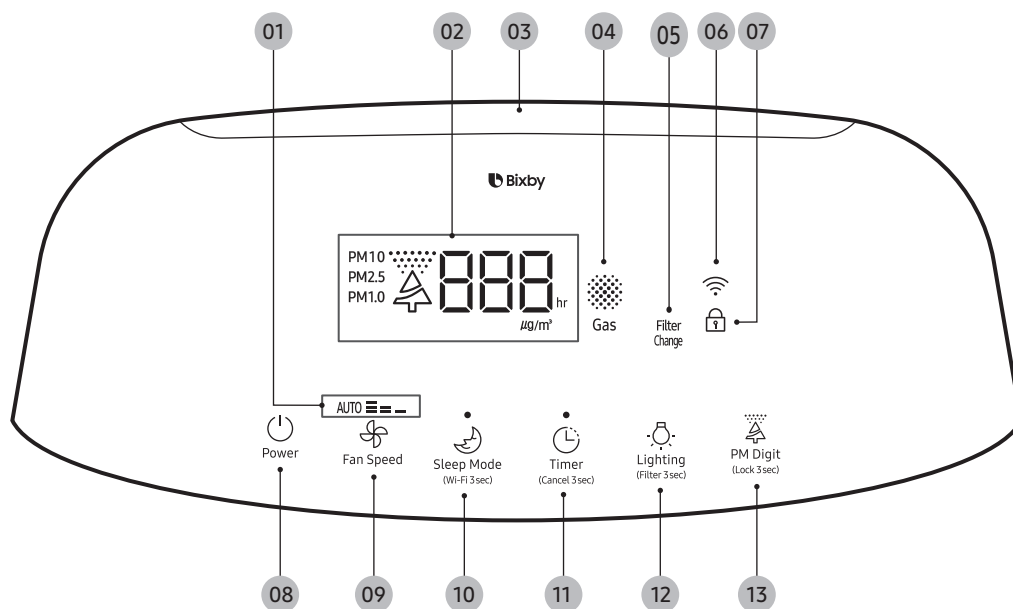

**01** Current fan speed

**02** PM10 / PM2.5 / PM1.0 pollution / Concentration / Timer indicator

**03** Air quality indicator

**04** Gas pollution indicator

**05** Filter replacement indicator

**06** Wi-Fi function indicator

**07** Lock indicator

**08** Power button

**09** Fan speed button

**10** Sleep mode /  
Wi-Fi On or Off button

**11** Timed on/off button

**12** Lighting / Filter reset button

**13** Air quality / Lock button

### NOTE

- PM10: Dust in the air with a diameter of 10 µm or less
  - Fine particles with about 1/5 of the diameter of a human hair
- PM2.5: Dust in the air with a diameter of 2.5 µm or less
  - Fine particles with about 1/20 of the diameter of a human hair
- PM1.0: Dust in the air with a diameter of 1.0 µm or less
  - Fine particles with about 1/50 of the diameter of a human hair

\* Diameter of a human hair: 50 to 70 µm

Bixby is the name of a Samsung AI solution and allows you to control the product with voice. To use the voice recognition function, you must connect the SmartThings app on your smartphone to the product. If the product does not support voice recognition directly, you can only control some functions using Bixby on your Samsung smartphone.

### NOTE

- Bixby only supports some languages, and the supported functions may differ depending on the geographical area.

# At a Glance

## Removing the filter

When using the 2-in-1 filter for the first time or replacing them with a new set, remove the vinyl packaging first.

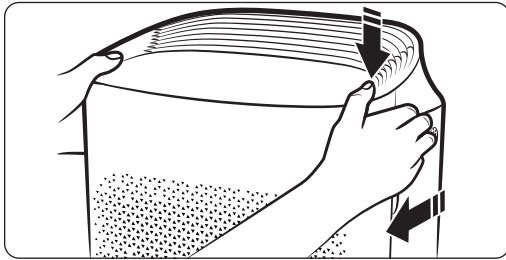

**STEP 1** Remove the front panel.

- Use your thumbs to press on the top of the product and pull the front panel forward with other fingers.



**STEP 2** Remove the pre-filter.

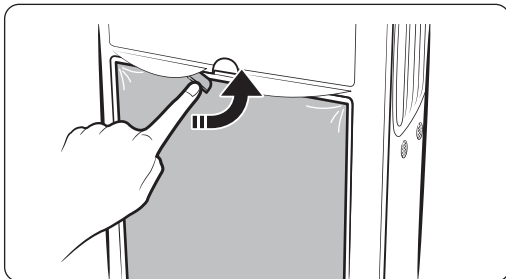

**STEP 3** Release the 2-in-1 filter.

- Rotate the filter holder 90° anticlockwise to release the filter.



**STEP 4** Remove the 2-in-1 filter.

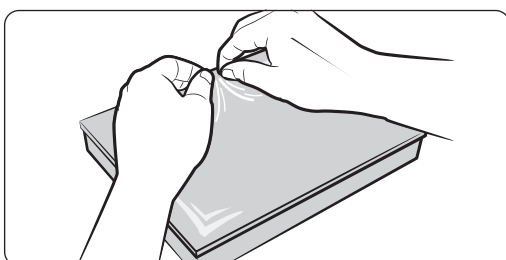

**STEP 5** Remove the vinyl packaging from the filter.

## Assembling the filter

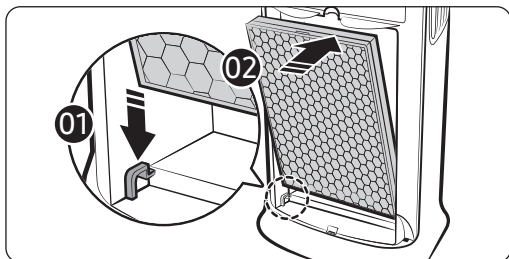

**STEP 1** Place the 2-in-1 filter.

- Let the filter sit inside the grooves at the bottom.
- Check the insert direction before placing the filter.

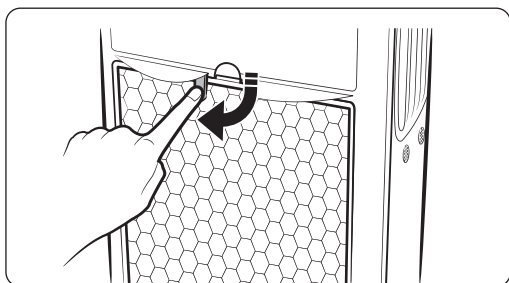

**STEP 2** Secure the 2-in-1 filter.

- Rotate the filter holder 90° clockwise to hold the filter in place.

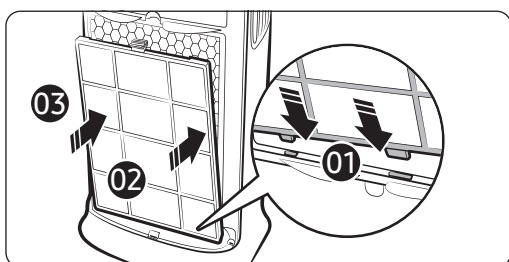

**STEP 3** Place the pre-filter.

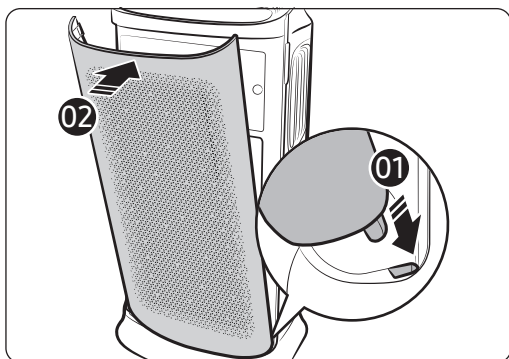

**STEP 4** Place the front panel.

- First, insert the hook on the panel into the groove at the bottom of the product.

# At a Glance

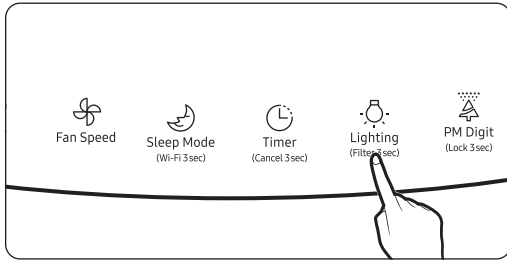

**STEP 5** Before using new filter, reset the filter replacement reminders.

- Press and hold the Lighting [Lighting (Filter 3sec)] button for 3 seconds or longer.

## NOTE

- The product is not as effective when it is operated without filter.
- You may notice a subtle odour from fresh filter when using your newly purchased air purifier for the first time,
  - which will disappear naturally in about a day.
- Keep the windows and doors closed whenever you can while the product is running. Ventilate the air regularly to avoid high concentration of carbon dioxide when you keep the room enclosed for a duration of time. When the filter have a weak smell, regular ventilation also reduces the smell.
- Carbon monoxide (CO) is a harmful gas that cannot be removed by the filter and usually comes from an outdoor origin.
- The frequency of filter cleaning and replacement may vary depending on the operating environment.

## Tips for using the 2-in-1 filter

- Operating the product without filter may cause abnormal air noise.  
Be sure to use the product with the 2-in-1 filter.
- In a room with persisting odours, using the product after ventilating the room first allows more effective odour control.
  - Operating the product while cooking food that has a strong odour may cause the deodorization filter to smell, and early replacement may be necessary.
  - If you operate the product after it has been unused for 2 weeks or more, or if there is a smell, run a cleaning operation by running the product in a well-ventilated space at the High fan speed for 4 hours or more, or dry the filter in the sunlight for 4 hours or more. This can help remove odours from the filter.
- The filter replacement reminder generates an alert when the maximum filter operation time has been reached based on the product uptime.  
The frequency of filter cleaning and replacement may vary depending on the operating environment.
- Do not wash the 2-in-1 filter with water. When using the product, be sure to keep the filter away from water.



- 
- The replacement cycle of the 2-in-1 filter can be between 6 months to 1 year, provided that the product operates 24 hours every day.  
(Filter can be used longer when the duration of product operation is shorter.) Filter life depends on the air quality.  
The life span of filter may shorten depending on the usage environment, the frequency of use, and the amount of contaminants adsorbed.
  - The indicator illuminates to notify when the filter need to be replaced. However, replace them regardless of the indicator status if they are visually dirty or smell, or if the output air flow is noticeably slowing down.
  - The dust collecting filter is a high performance filter that removes fine particles in the air such as particulate matter (PM) and cigarette smoke particles.
  - The deodorization filter is a high-performance active carbon (charcoal) filter, effectively controlling household odours from a toilet, food, and such.
  - If the filter begin to smell when you operate the product due to absorbed odourants or heavy use, they are no longer usable and need to be replaced.
    - The 2-in-1 filter is a consumable material, and even if the warranty period is free, replacement of filter that occurs during use will be charged.
  - You can purchase new replacement filter from a Samsung Service Centre.

# Operation Features

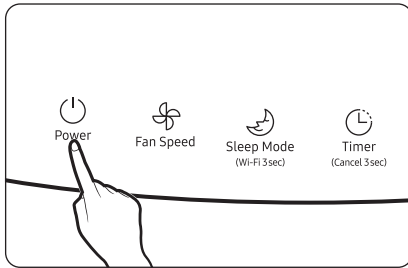

## Turning the power on/off

- Press the Power button. The air purifier turns on with a notification sound and automatically begins operation.
  - Sensor preparation begins upon startup with a display indication and continues for 12 seconds. The air quality is then indicated by colour and the concentration level.
  - Coloured air quality indicator: PM10, PM2.5 and PM1.0 levels, and gas pollution display: PM10, PM2.5, PM1.0

### Sensor loading display



- When you turn off the power and turn it back on, the product operates at the last fan speed you used.

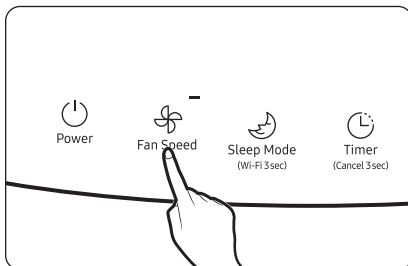

## Controlling the fan speed

Use the button to select the intensity of air flow to purify the indoor air.

- Press the Fan speed [  ] button to change between the options.
  - Each time you press the button, the fan speed changes in the order of Low → Auto → High → Medium → Low.
- In Auto mode, the fan speed is automatically adjusted to the particle and odour levels around it to keep the room clean.

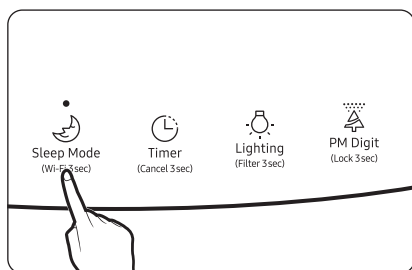

## Sleep mode

Sleep mode provides a clean, quiet and comfortable room for a good night's sleep.

- Use Sleep mode to only allow the mode indicator and turn off all other display indicators.
- Changing the fan speed when Sleep mode has been active for 10 seconds or more will cancel the mode and the sensor loading display will appear. (See 'Sensor loading display' on page 10.)
- Lock feature becomes unavailable while Sleep mode is on.

### Cancel

- Press the Sleep mode [  ] button or Fan speed [  ] button.

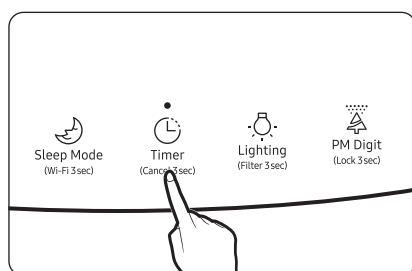



## Timed on/off function

The product automatically turns off after a specified duration.

- You can select between 1 hour to 12 hours by pressing the Timed on/off [  ] button when the product is powered on. Time can be adjusted by hour.
- Timed off is scheduled 3 seconds after selecting the desired operating hours.

### Cancel

- Press and hold the Timed on/off [  ] button for at least 3 seconds or press the Timed on/off [  ] button to set the timer to .

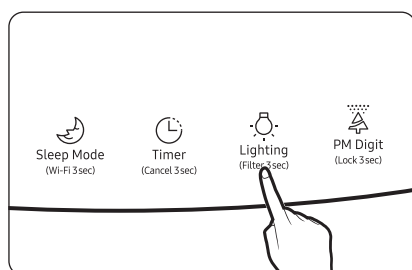

## Display lighting

The air quality is displayed in pleasantly dimmed colour lighting.

- It reflects the PM10, PM2.5, PM1.0 or gas pollution level, whichever is the worst.
- Colours do not apply when using the product in Sleep mode.

### Cancel

- Press the Lighting [  ] button.

# Operation Features

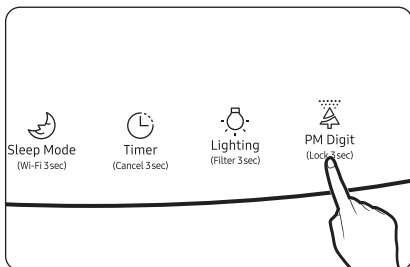
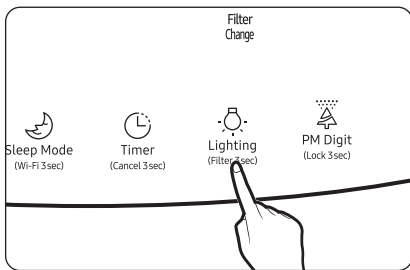
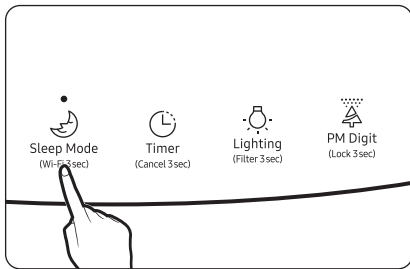

## Turning the Wi-Fi feature on/off

You can turn the Wi-Fi feature on or off.

- Press and hold the Sleep mode [Sleep Mode (Wi-Fi 3sec)] button for 3 seconds or more to turn the Wi-Fi on or off.
- To use this feature, first register the product to Samsung SmartThings app. Once connected, the Wi-Fi icon will automatically light up.
  - The Wi-Fi icon only lights up when the product is connected to SmartThings app.
  - About connecting to SmartThings app, see page 16.

## Clearing the filter replacement reminder

This feature notifies when to replace the 2-in-1 filter (Deodorization Filter+Dust Collecting Filter).

- If you hear a beep and the filter replacement indicator [Filter Change] lights up while the product is in use, replace the filter and press the Lighting [Lighting (Filter 3sec)] button for 3 seconds or more to reset. The replacement reminder turns off after [Filter Change] blink twice with the notification sound.
- Likewise, if the filter have been replaced before [Filter Change] activation for other reasons, reset the status by pressing the Lighting [Lighting (Filter 3sec)] button for longer than 3 seconds.
- After resetting the filter, press the Lighting [Lighting (Filter 3sec)] button to reset this feature as well.

### ⚠ CAUTION

- The filter change indicator may not work properly if you continue to use old filter without replacement or perform the reset process without filter.

## Lock function

Use this feature to lock all buttons and prevent unintended button operation, especially by children.

- Press and hold the Air quality [PM Digit (Lock 3sec)] button for 3 seconds or more to activate this feature, which locks all buttons after a beep.
- All buttons become inaccessible while Lock feature is on.

Cancel

- Press and hold the Air quality [PM Digit (Lock 3sec)] button for 3 seconds or more. The feature is released after a beep.

## Checking the air quality

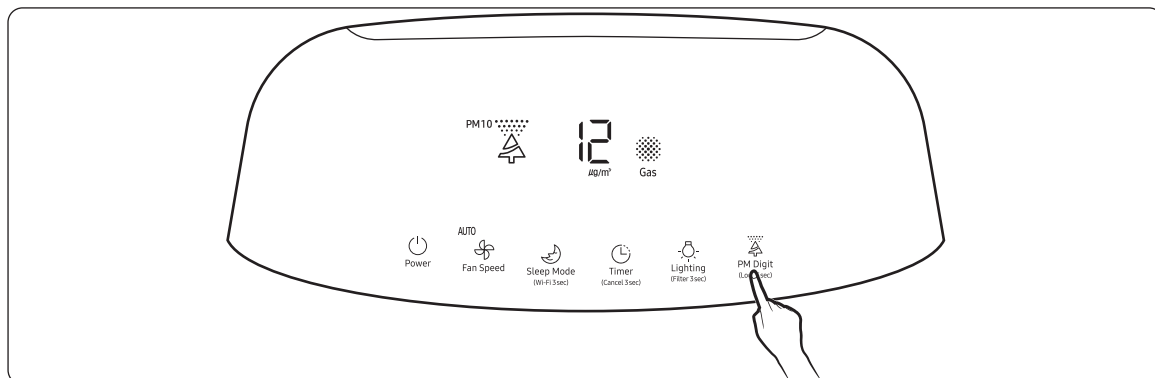

You can review the current air quality from the display panel with the colour (reflecting the PM10 / PM2.5 / PM1.0 / gas pollution) and the concentration level indicators.

- By default, the colour and PM10 / PM2.5 / PM1.0 level indicators reflect the PM10 concentration.
- Each time you press the Air quality [PM Digit] button, the current state is displayed in the order of PM10 → PM2.5 → PM1.0. The PM2.5 and PM1.0 levels are displayed for 10 seconds, before automatically changes to the PM10 level.
  - The air quality will be 'Very Poor' when the PM2.5 / PM1.0 levels are worse than the PM10 level.
  - If the concentration levels are same for all PM groups, the indicator will reflect the PM10 level.
- Air quality levels

Pollution level		PM10 level ( $\mu\text{g}/\text{m}^3$ )	PM2.5 / PM1.0 level ( $\mu\text{g}/\text{m}^3$ )	Gas pollution level
Very poor	Red	151 and over	76 and over	4
Poor	Yellow	81 - 150	36 - 75	3
Moderate	Green	31 - 80	16 - 35	2
Good	Blue	30 and below	15 and below	1

- PM10, PM2.5 and PM1.0 measurement will be displayed in numbers 05 – 999.

### NOTE

- The dust concentration may vary depending on the environmental conditions (for example, when the product is near a construction site, road, or fabric sofa, or when a vacuum cleaner is used or bedding and clothes are arranged near the product, etc.).
- The following conditions may cause temporarily high readings of PM level:
  - When the product is used near fur rugs or used in vets, clothes stores, or other places prone to high humidity, smoke or infestation
  - When humidifiers, electric pressure cookers, sprayers and such are being used in the same room
  - When the product is used where there is inflow of outside air with dust or other types of air pollution (e.g. proximity to the building's HVAC or ventilation systems, or loose window frames)
- The gas pollution reading can be affected by odorous household items such as air fresheners, deodorants and detergents.
- If you are using more than one air purifier in the same room, the dust concentration reading on each unit may not be same as they affect air circulation. The dust concentration reading may vary depending on the sensor or product being used.
- If there is no change in the intensity of gas (odour), it may not be reflected in the gas pollution reading even though you can clearly smell it.
- PM levels on the display may differ from the official forecasts.
- Nearby electromagnetic waves or electrical noises may cause temporarily high readings of PM level.

# Cleaning and Maintenance

---

Be sure to disconnect the power plug from the socket before cleaning the product.

## Cleaning the air purifier exterior

---

- Dampen a soft cloth with lukewarm water and wring it out, and then wipe the product exterior with it.
- Wipe the grooves on the front panel with a cotton swab.
- If it is too hard to clean the dust from the front panel, remove the panel and wash it with water.

### CAUTION

- Do not wipe the product with an alkaline detergent.
- Do not wipe the product surface with sulphuric acid, hydrochloric acid, or organic solvents (thinner, kerosene, acetone, etc.). Do not attach a sticker to the product. Failure to do so may result in damage to the product surface.

## Cleaning the sensors

---

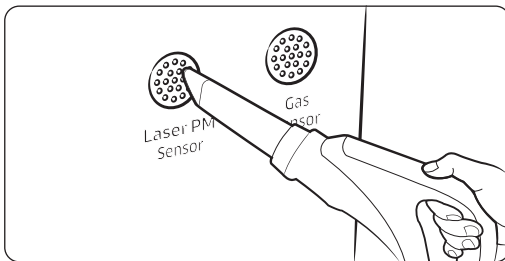

- If there is dust or foreign substance on a sensor, use a vacuum cleaner to clean the sensor and its surrounding.

### CAUTION

- Do not put any dust into the sensor openings.

---

## Cleaning and drying the filter

---

### NOTE

- About removing/assembling the filter, see pages 6 and 7.

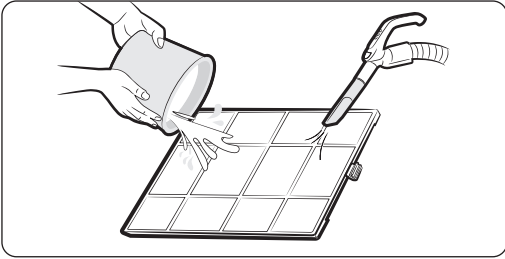

### Cleaning the pre-filter

---

- Depending on the dust accumulation, first remove dust with a vacuum cleaner and gently wash the filter with a pH-neutral detergent diluted in lukewarm water.
  - Cleaning interval: 2 weeks (when using the product 24 hours every day)

### CAUTION

- Cleaning the pre-filter by rubbing with a brush or a similar tool may damage the superfine fibres.

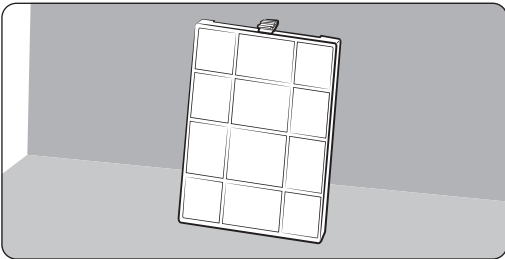

### Drying the filter

---

- Keep the filter in the shade until completely dry and away from direct sunlight.

# SmartThings app

To use the SmartThings app, connect the product to the network in the sequence described below. The images shown may differ depending on your smartphone model, OS version and manufacturer. You need to set up the Wi-Fi access point only when connecting the product to a Wi-Fi network. Once the product is connected, you can use the SmartThings app via Wi-Fi, 3G, LTE or more wireless networks.

## 1 Checking the power connections

Check if the power is connected to the product and the access point.

## 2 Setting up and connecting to a Wi-Fi access point using your smartphone

1 To connect the product to a Wi-Fi network, turn on Wi-Fi at "Settings > Wi-Fi", and then select the access point to connect to

- Only alphanumeric characters are supported for wireless access point names (SSIDs). If an SSID has a special character, rename it before connecting to it.
- This product supports only Wi-Fi 2.4 GHz.

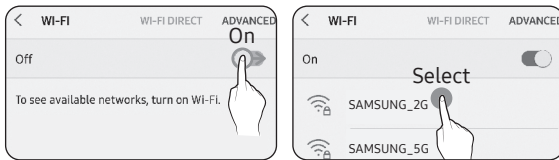

2 Turning off "SMART NETWORK SWITCH" at "Settings > Wi-Fi" on your Smartphone

- If "SMART NETWORK SWITCH" or "Adaptive Wi-Fi" is turned on, you cannot connect to the network. Be sure to turn off these functions before connecting to the network.

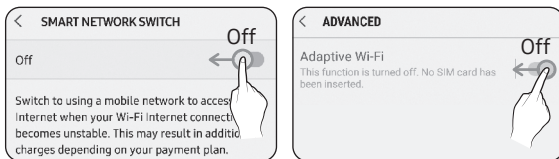

### NOTE

- The setup may differ depending on your smartphone model, OS version and manufacturer.

## 3 Checking the Internet connectivity

- After connecting to Wi-Fi, check that your smartphone is connected to the Internet.

### NOTE

- A firewall may prevent your smartphone from connecting to the Internet. Contact your Internet service provider for troubleshooting.

## 3 Downloading the SmartThings app and registering your Samsung account

### 1 Downloading the SmartThings app

- Search for "SmartThings" on Play Store or App Store, and download the SmartThings app to your smartphone.
- If the SmartThings app is already installed on your smartphone, update it to the latest version.



### NOTE

- For the tablets that are not supported by the SmartThings app and the smart phones that has an OS version earlier than the recommended versions, the SmartThings app may not be found.
  - Android OS 6.0 or later (with at least 2 GB RAM) is recommended.
  - Supported screen resolutions: 1280 x 720 (HD), 1920 x 1080 (FHD), 2560 x 1440 (WQHD)
- The SmartThings app is not compatible with some Apple devices including iPad and some smartphones.
  - iPhone 6 or later with iOS 10.0 or later is supported.
  - Supported screen resolutions: 1334x750, 1920x1080
- The SmartThings app may change without prior notice to improve product usability and performance.



## 2 Registering your Samsung account

- A Samsung account is required to use the SmartThings app. To create your Samsung account and log in to your account, follow the instructions displayed on the SmartThings app. You do not need to install an additional app.

### NOTE

- If you already have a Samsung account, log in to the account. If you have a smartphone that is a Samsung device and you have a Samsung account, your smartphone is automatically logged in to your account.
- If you log in from a smartphone produced for other country, you need to log in with its country code when you create your Samsung account, and the SmartThings app may not be used on some smartphones.

## 4 Connecting the SmartThings app to your product

### 1 Selecting the product to connect to

- 1) Start the SmartThings app about one minute after turning on the product to connect to.
- 2) After the SmartThings app is started, select 'ADD NOW' when a pop-up window saying that a product to connect to is found appears.

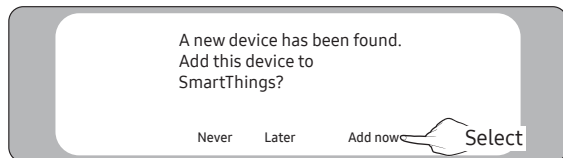

- 3) If the pop-up window does not appear, select "+", and then "Add Devices."



You can add a product you want to connect to by selecting it manually or by selecting "Auto detect".

- Select manually: Samsung > Air purifier
- Auto detect: [Air purifier] Samsung

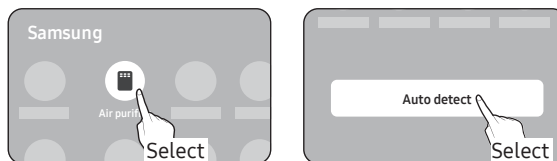

### 2 Connecting the SmartThings app to your product

- Follow the instructions displayed on the SmartThings app to connect to your product.
- For information on how to use the SmartThings app, select the How To menu on the app.

### NOTE

- If any pop-window appears on the top of the smartphone while connecting to your product, do not select it.
- If a pop-up window saying that the device is already registered appears during connecting to your product, get permission using "REQUEST PERMISSION" from a user already connected to the product, or create a new account using "REGISTER MY ACCOUNT" to independently connect to the product.
- If a Samsung account-related country error occurs during connecting to your product, log out of your current Samsung account, log in to your previous Samsung account, and then delete all devices that have been connected previously. Then, log in to your current Samsung account again, and then configure the settings.
- If a failure message appears while adding a device, see "Setting up and connecting to a Wi-Fi access point using your smartphone" on page 16. The connection may fail temporarily due to an installation location problem of the access point or other problems.
- If a message appears on the SmartThings app, follow its instructions.

# SmartThings app

---

## NOTE

- For the security protocols for wireless/wired access points, WPA-PSK and WPA2-PSK are recommended. For the authentication methods, AES is recommended. New Wi-Fi authentication specifications and Wi-Fi nonstandard authentication methods are not supported.
- The product supports the IEEE802.11 b/g/n (2.4 GHz) communication protocol. (Samsung recommends IEEE802.11n.)
- If your Internet service provider permanently have registered the MAC address (a unique identification number) of your PC or modem, you may not be able to connect your product to the Internet. Contact your Internet service provider and ask how to connect devices other than your PC (such as an air conditioner and an air purifier) to the Internet.

## Open Source Announcement

---

The software included in this product contains open source software. You may obtain the complete corresponding source code for a period of three years after the last shipment of this product by sending an email to <mailto:oss.request@samsung.com>.

It is also possible to obtain the complete corresponding source code in a physical medium such as a CD-ROM; a minimal charge will be required.

The following URL [http://opensource.samsung.com/opensource/SMART\\_AT\\_051/seq/0](http://opensource.samsung.com/opensource/SMART_AT_051/seq/0) leads to the download page of the source code made available and open source license information as related to this product. This offer is valid to anyone in receipt of this information.



## Controlling your air purifier with SmartThings app

Smartly control your air purifier using the SmartThings app.

Category	Function	Description
Monitoring	Indoor air quality	<p><b>Check the indoor air cleanliness.</b></p> <ul style="list-style-type: none"> <li>• Touch the ⓘ icon to view the PM10 / PM2.5 / PM1.0 levels and gas cleanliness.</li> <li>• Some of the options may not be available on your air purifier.</li> <li>• Models that use the dongle do not support PM1.0 pollution level display.</li> </ul>
	Outdoor air quality	<p><b>You can access to air quality information for your area.</b></p> <ul style="list-style-type: none"> <li>• Touch the ⓘ icon to view detailed air quality information for the region you specified in the settings.</li> <li>• If you cannot view any outdoor air quality information, specify your region in the settings.</li> </ul>
Control	Power supply	<b>Turn your air purifier on or off.</b>
	Controlling the fan speed	<b>Select the fan speed you want.</b>
	Timed on/off	<p><b>Set the timed on/off times.</b></p> <ul style="list-style-type: none"> <li>• You can set a total of up to 10 timed on/off times.</li> <li>• You cannot set the same time for both of the timed on and timed off times.</li> <li>• While you are setting a timed on/off time, no timed on/off indications are displayed on your air purifier display.</li> <li>• Once you set a timed on/off time, it persists even if you unplug and plug in the power cord of your air purifier.</li> </ul>
	Operation functions	<p><b>Touch the buttons for various additional functions you want to run.</b></p> <ul style="list-style-type: none"> <li>• Some of the options may not be available on your air purifier.</li> </ul>
	settings	<p><b>Check the settings for region, lighting, mute, or filter.</b></p> <ul style="list-style-type: none"> <li>• If you change the region, your display panel will show the outdoor air quality information for the new region.</li> <li>• You can check the filter replacement time and reset the filter replacement reminder using Filter Info. You can also view the information about replacement filter.</li> <li>• Some of the options may not be available on your air purifier.</li> </ul>
	Help	<b>Useful information to help you understand air related information and terms.</b>
	Device information	<p><b>View or open the version, tutorial, manual, store, self diagnosis, help desk.</b></p> <ul style="list-style-type: none"> <li>• Some of the options may not be available on your air purifier.</li> </ul>

# Before Requesting Service

Check the following before requesting service from the Service Centre.

## Operation

### The air purifier does not operate.

- Check the power supply and turn on the air purifier again.
- Make sure that the power plug is plugged in, and then turn on the air purifier again.  
If it still does not operate, try a different power outlet.
- Make sure that the front panel is closed properly.

## Sound

### The air purifier makes strange noises.

- If you move the product during operation, it may cause noise. Turn off the power before moving the product.

## Odours

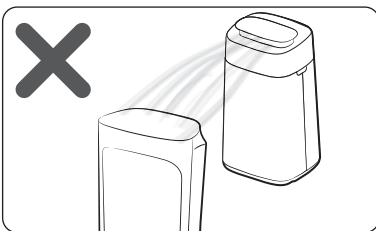
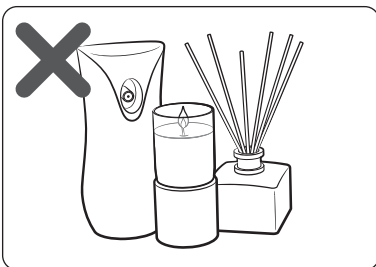
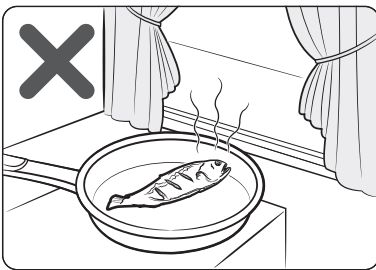

### The air purifier smells strange.

- Because the air purifier sucks and circulates indoor air, if you use it in a closed space for a long time, odours generated in your home can saturate the filter.
  - Remove the pre-filter, 2-in-1. See if any of them smell and clean or replace them when necessary.  
You will be charged for replacing filter regardless of the remaining warranty.
  - Open the doors and windows, and then operate the product for 3 to 4 hours.
  - When grilling or frying food ingredients such as fish and meat, ventilate the room well and operate the air purifier once the odours are sufficiently removed.
- Filter can become the source of odours when you use the product along with air fresheners, diffusers, scented candles or cleaning agents, or in a recently furnished room (e.g. new paint or wallpaper).
  - Ventilate until the odours are completely removed, and then operate the product.
- Operating your air purifier in a room that is constantly humid or exposing it to moisture from a humidifier can cause the filter to smell after some time.
  - If the filter smell due to moisture, dry them well in sunlight before using them again.

## Cleanliness

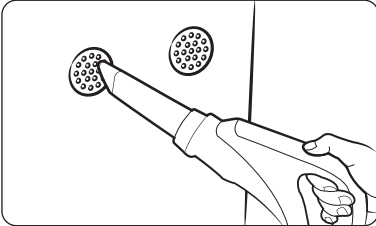

### The cleanliness colour indicator continuously lights up in red. (The cleanliness indications are strange.)

- Check the sensors for any foreign substances and clean them if necessary.
- In winter season, installing and operating the product for the first time shortly after delivery may cause the pollution level to reach  $999 \mu\text{g}/\text{m}^3$  with the indicator illuminated in red. This is a temporary issue that happens if there is a significant temperature change from outdoor exposure causing condensation inside the unit. In this case, do not be alarmed and continue using the product. The status will be cleared within 1 to 2 hours of operation.
- The gas sensor reacts to changes in the indoor odourant level due to cooking or ventilation, causing the indicator to illuminate in red. When this happens, ventilate the room for 1 to 2 hours.
- Disconnect the power plug, then put it back after 1 minute. (To reset the sensor)
- If the indicator colour stays in red after you have followed all the provided instructions and solutions, it may be a sensor issue. In this case, please contact your local Samsung Service Centre.
- When humidifiers, electric pressure cookers, sprayers and such are being used in the same room, the pollution level may be measured as Poor.

### The fan speed does not change according to cleanliness.

- Set the fan speed to Auto. The fan speed does not change automatically when it is set to Low, Medium or High, and when Sleep mode is on.

### The PM10, PM2.5, PM1.0 concentration values do not change from the Good (05) level.

- This may happen when the room is properly sealed and the air is clean. To check if the sensor is functioning, test it by tearing paper by the sensor and/or rub them to create some dust. This will cause the PM levels to change if the sensor is working properly.
  - Dusting off or cleaning the room may not necessarily cause sensor feedback if the dust particles are bigger than PM10, while they are still filtered and removed from the air.

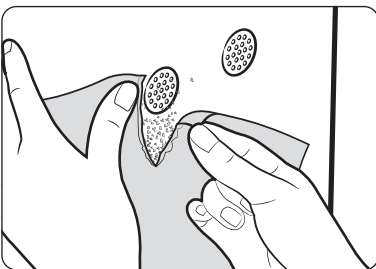

# Before Requesting Service

---

## Display

**The PM10, PM2.5, PM1.0 concentration values are the same continuously.**

- When the air is clean, you may not see a difference between the PM10, PM2.5 and PM1.0 levels.  
To check if the sensor is functioning, test it by tearing paper by the sensor and/or rub them to create some dust. This will cause the PM levels to change if the sensor is working properly.

**The filter replacement indicator is always turned on.**

- After replacing the filter, press and hold the [Lighting] button for 3 seconds or more to reset the filter replacement reminder.

**Strange indications appear on the display.**

- If any of the indications *E 103, 105, 154, 163* appears, contact a Samsung Service Centre.

## Air circulation

**The fan does not seem to circulate the air evenly.**

- Your air purifier is designed to send the clean air upwards for effective circulation. Since the air circulates clockwise, you may find the output on the right relatively stronger, and weaker on the left.

# Safety Precautions

---





These safety precautions are for owner's safety and preventions of property damage. Therefore, please read this manual thoroughly before using your product.

## **WARNING**

Hazards or unsafe practices that may result in severe personal injury or death.

## **CAUTION**

Hazards or unsafe practices that may result in minor personal injury or property damage.

-  Follow directions.
-  Do NOT attempt.
-  Make sure the machine is grounded to prevent electric shock.
-  Unplug the power plug from the wall socket.
-  Do NOT disassemble.

## **FOR INSTALLATION**

---

## **WARNING**

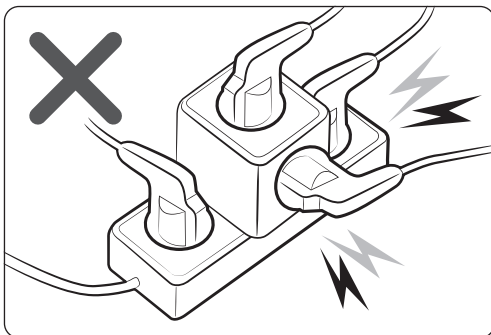

Only connect to a socket that can provide the rated power supply. Do not use the socket with other products. Do not extend the power cord.

- Using a multi-socket with other products or extending the power cord may cause electric shock or fire.
- Using a voltage converter may cause electric shock or fire.
- Failing to meet the exact voltage, frequency and/or rated current may cause electric shock or fire.

-  Do not install the air purifier near a heat source and inflammable objects, or in areas that are highly humid or dusty. Avoid exposure to oil, gas, direct sunlight and water.
  - Follow instructions to avoid electric shock or fire.

## **CAUTION**

-  When installing the product, make sure that the power plug can be easily removed when needed.

- Follow instructions to avoid electric shock or fire due to electrical leakage.

**Install the product on a solid flat ground.**

- Follow instructions to avoid excessive vibration, noise and operational issues thereof.

# Safety Precautions

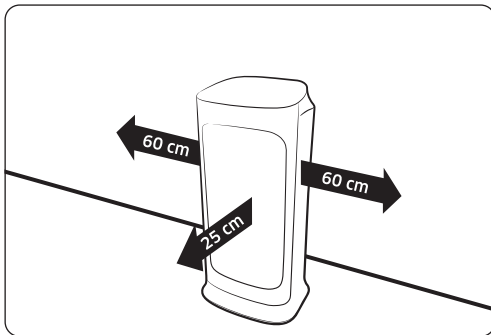

Keep a safe distance from surrounding objects.

- Clear space from each side: at least 60 cm and the front: at least 25 cm
- The space is necessary to ensure efficient air intake and proper purification.
- Make sure that the inlet and outlet are not covered.

Make sure that the power cord is not pressed under the product.

- Follow instructions to avoid electric shock or fire.

## FOR POWER SUPPLY

### WARNING

 Use a dry cloth to wipe the power plug and the contact area to keep them free from dust, water and other undesirable substances.

- Follow instructions to avoid electric shock or fire.

Check the position of the power plug when you connect it to a socket.

- Having the cord hanging from above the plug may damage the wires inside, which can lead to electric shock or fire.

Please contact your local Samsung Service Centre if the power plug or cord is damaged.

 Make sure that the power plug is securely fitted in the socket. Do not use it when the plug or cord is damaged.

- Follow instructions to avoid electric shock or fire.

When you disconnect the power cord, pull it by the plug. Do not pull the cord itself.

- Follow instructions to avoid electric shock or fire.

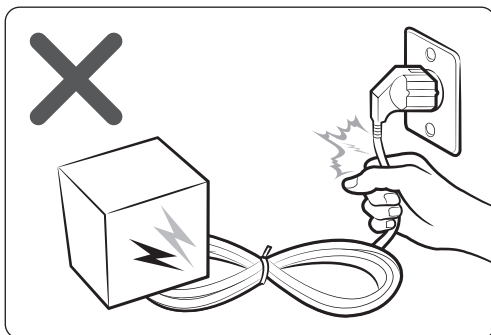

Do not fold, pull out, twist or tie the power cord. Do not hang it over a metal object or place a heavy object on it. Do not put the cord between objects or behind the air purifier.

- Follow instructions to avoid electric shock or fire.



---

**⚠ CAUTION**

**🔌** Remove the power plug of your air purifier when it is not used for a period of time and during a thunderstorm.

- Follow instructions to avoid electric shock or fire.

Product installation must be handled by official Samsung service personnel or a certified local technician to avoid power cord or plug damage, which can be dangerous.

Disconnect the air purifier from the power source before cleaning or repairing.

**FOR USING**

---

**⚠ WARNING**

**❗** If the product is exposed to water, immediately disconnect it from the power source and contact your local Samsung Service Centre.

- Follow instructions to avoid electric shock or fire.

If you notice a noise, burning smell or smoke from the product, immediately stop using it and contact your local Samsung Service Centre.

- Follow instructions to avoid electric shock or fire.

In the event of a gas leak in proximity of the air purifier, do not touch it or attempt to unplug it. Immediately ventilate the room and contact your provider or a certified technician for advice.

- Do not turn the ventilation fan on.
- A spark can cause an explosion or fire.

**Do not pull out the power plug while operating the air purifier.**

- This may cause a spark when reconnecting the plug, which can lead to an explosion or fire.

**Please contact your local Samsung Service Centre when you require repair service.**

- Follow instructions to avoid electric shock or fire.

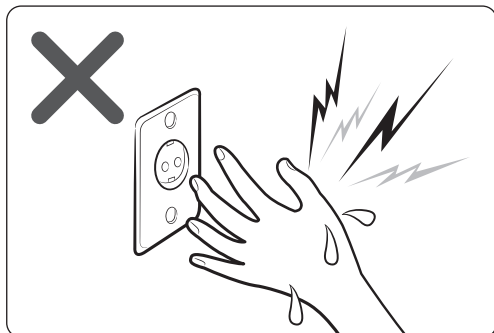

**Do not handle the power plug with wet hands.**

- Follow instructions to avoid electric shock or fire.

# Safety Precautions

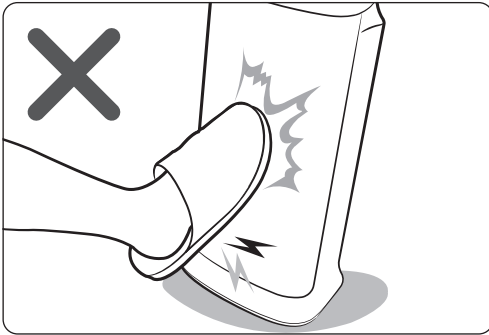

**Do not use force on the air purifier or pull the unit away.**

- Follow instructions to avoid fire, malfunction or injury.

**Store the plastic package away from children or discard it according to the law.**

- Follow instructions to protect children from a risk of suffocation.

**Do not insert your finger or other objects into the air inlet or outlet.**

- Take special care to protect children from injury.

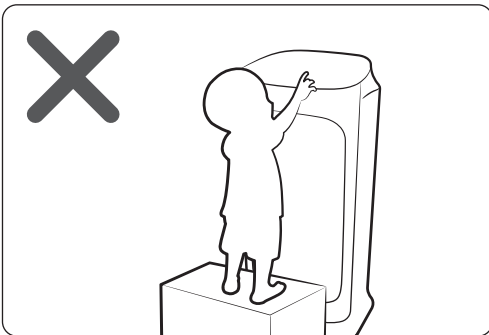

**Do not place an object near the air purifier as children may use them to climb onto the product.**

- Follow instructions to avoid injury from a tip-over or fall.

**If the power plug area has contacted water, completely dry it before using the air purifier again.**

- Follow instructions to avoid electric shock or fire.

**Do not insert a metal object and similar items inside the air purifier.**

- Follow instructions to avoid electric shock or injury.

**Do not place a heavy object on the air purifier.**

- Follow instructions to avoid malfunction or noise.

 **If any of the electric components inside the air purifier has contacted liquid or water, disconnect the product from the power source and contact your local Samsung Service Centre.**

- Follow instructions to avoid electric shock or fire.

 **Do NOT attempt to repair or modify the product.**

- Use only the standard rated fuse.
- Follow instructions to avoid electric shock, fire, malfunction or injury.

---

 **CAUTION**

 Keep your air purifier at least 2 meters away from a TV or other audio/visual media.

- They can be affected by video or audio noise.

**Secure enough space around the air purifier when operating.**

- Clear space from each side: at least 60 cm and the front: at least 25 cm
- Your air purifier is designed to take in air through the front inlet for purification. Keep the area around the inlet clear and make sure that both the inlet and outlet are not covered by curtains and such.

 **Do not step on the product or place other objects on it (laundry, candles, burning cigarettes, plates, medicine, metal items, air fresheners, etc.).**

- Follow instructions to avoid electric shock, fire, malfunction or injury.

**Do not tilt or flip the air purifier while the power plug is connected to the socket.**

- Follow instructions to avoid malfunction or fire.

**Do not use bug repellent or other spray products on the air purifier.**

- They can be harmful and may cause electric shock, fire or malfunction.

**Do not submerge the air purifier.**

- Follow instructions to avoid malfunction.

**Do not handle the product with wet hands.**

- Follow instructions to avoid electric shock.

**This appliance can be used by children aged from 8 years and above and persons with reduced physical, sensory or mental capabilities or lack of experience and knowledge if they have been given supervision or instruction concerning use of the appliance in a safe way and understand the hazards involved. Children shall not play with the appliance. Cleaning and user maintenance shall not be made by children without supervision.**

---

**FOR CLEANING**

 **WARNING**

 **Do not apply water, benzene, thinner, alcohol, acetone or similar substances directly on the product.**

- Follow instructions to avoid product discolouration or deformation, electric shock or fire.

**Disconnect the product from the power source when cleaning. Wait for the fan to completely stop before cleaning.**

- Follow instructions to avoid electric shock or fire.

 **CAUTION**

 **Be sure to disconnect the power plug from the socket before cleaning the product.**

# Reference

Wi-Fi	
1) Frequency Range	2) Transmitter Power (Max)
2412 - 2472 MHz	20 dBm

English	1) Frequency Range 2) Transmitter Power(Max)
French	1) Plage de fréquence 2) Puissance de l'émetteur (Max.)
Italian	1) Intervallo frequenza 2) Potenza trasmettitore (Max)
Polish	1) Zakres częstotliwości 2) Moc nadajnika (maksymalna)
Dutch	1) Frequentiebereik 2) Zendvermogen (max.)
Bulgarian	1) Честотен диапазон 2) Мощност на предавателя (макс.)
Romanian	1) Gama de frecvență 2) Puterea transmițătorului (Max.)
Hungarian	1) Frekvenciatartomány 2) Jeladó teljesítmény(Max)
Czech	1) Frekvenční rozsah 2) Výkon vysílače (max.)
Slovak	1) Frekvenčný rozsah 2) Výkon vysieláča (max.)

English	Hereby, Samsung declares that this radio equipment is in compliance with Directive 2014/53/EU and with the relevant statutory requirements in the UK. The full text of the EU declaration of conformity and the UK declaration of conformity is available at the following internet address: The official Declaration of conformity may be found at <a href="http://www.samsung.com">http://www.samsung.com</a> , go to Support > Search Product Support and enter the model name.
French	Par la présente, Samsung déclare que cet équipement radio est conforme à la directive 2014/53/UE et aux exigences réglementaires applicables au Royaume-Uni. Le texte intégral de la déclaration de conformité de l'UE et de la déclaration de conformité du Royaume-Uni est disponible à l'adresse Internet suivante : La Déclaration officielle de conformité se trouve sur <a href="http://www.samsung.com">http://www.samsung.com</a> , rendez-vous sur la page d'assistance > Rechercher dans l'Assistance et saisissez un nom de modèle..
Italian	Con la presente, Samsung dichiara che questa apparecchiatura radio è conforme alla Direttiva 2014/53/UE e ai relativi requisiti di legge nel Regno Unito. Il testo integrale della dichiarazione di conformità EU e del Regno Unito è disponibile al seguente indirizzo: La dichiarazione ufficiale di conformità è disponibile su <a href="http://www.samsung.com">http://www.samsung.com</a> , selezionare supporto> Cerca Supporto Prodotto e inserire il nome del modello.
Polish	Niniejszym firma Samsung deklaruje, że ten sprzęt radiowy jest zgodny z wymogami dyrektywy 2014/53/UE oraz odnośnych ustaw obowiązujących w Wielkiej Brytanii. Pełny tekst deklaracji zgodności z przepisami europejskimi i brytyjskimi jest dostępny na stronie internetowej: Treść oficjalnej deklaracji zgodności jest dostępna pod adresem <a href="http://www.samsung.com">http://www.samsung.com</a> w menu Wsparcie > Szukaj, gdzie należy podać nazwę modelu.
Dutch	Samsung verklaart hierbij dat deze radioapparatuur voldoet aan Richtlijn 2014/53/EU en aan de relevante statutaire vereisten in het VK. De volledige tekst van de EU-Conformiteitsverklaring en de conformiteitsverklaring van het VK vindt u op deze website: De officiële Conformiteitsverklaring vindt u op <a href="http://www.samsung.com">http://www.samsung.com</a> , ga naar Ondersteuning > Productondersteuning zoeken en voer de modelnaam in.

# Reference

Bulgarian	<p>С настоящото Samsung декларира, че това радиооборудване е в съответствие с Директива 2014/53/ЕС и със съответните законови изисквания в Обединеното кралство. Пълният текст на ЕС Декларацията за съответствие и Декларацията за съответствие за Обединеното кралство е наличен на следния интернет адрес: Официалната Декларация за съответствие можете да намерите на <a href="http://www.samsung.com">http://www.samsung.com</a>, отидете на отидете на поддръжка &gt; Търсене на поддръжка за продукт и въведете името на модела.</p>
Romanian	<p>Prin prezenta, Samsung declară faptul că acest echipament radio respectă Directiva 2014/53/UE și toate cerințele legale relevante din Regatul Unit. Textul complet al declarației de conformitate UE și al declarației de conformitate din Regatul Unit este disponibil la următoarea adresă de internet: Declarația de conformitate oficială poate fi găsită la <a href="http://www.samsung.com">http://www.samsung.com</a>, accesați asistența &gt; Căutați asistența produsului și introduceți numele modelului.</p>
Hungarian	<p>A Samsung ezennel kijelenti, hogy ez a rádióberendezés megfelel a 2014/53/EU irányelvnek és az Egyesült Királyságban a vonatkozó jogszabályi követelményeknek. Az EU megfelelőségi nyilatkozat és az Egyesült Királyság megfelelőségi nyilatkozat teljes szövege a következő internet cím alatt található: A hivatalos Megfelelőségi nyilatkozat a <a href="http://www.samsung.com">http://www.samsung.com</a> honlapon olvasható, lépjen a Támogatás &gt; Terméktámogatás keresése menüpontra, és adja meg a modell nevét.</p>
Czech	<p>Společnost Samsung tímto prohlašuje, že toto radiové zařízení splňuje požadavky směrnice 2014/53/EU a příslušné požadavky právních norem platných ve Spojeném království. Úplné znění EU Prohlášení o shodě a UK Prohlášení o shodě je k dispozici na následující internetové adrese: Oficiální prohlášení o shodě naleznete na webu <a href="http://www.samsung.com">http://www.samsung.com</a>, kde klepněte na odkaz Podpora a do pole Hledat Podporu zadejte název modelu.</p>
Slovak	<p>Spoločnosť Samsung týmto vyhlasuje, že toto zariadenie rádiového typu je v súlade so smernicou 2014/53/EÚ a náležitými zákonnými požiadavkami v Spojenom kráľovstve. Celé znenie Vyhlásenia o zhode v EÚ a Vyhlásenia o zhode v Spojenom kráľovstve je k dispozícii na nasledujúcej internetovej adrese: Oficiálne Vyhlásenie o zhode sa nachádza na lokalite <a href="http://www.samsung.com">http://www.samsung.com</a>, prejdite na položky Podpora &gt; Vyhľadávanie podpory produktov a zadajte názov modelu.</p>

# Memo

---

## QUESTIONS OR COMMENTS?

COUNTRY	CALL	OR VISIT US ONLINE AT
UK	0330 SAMSUNG (7267864)	<a href="http://www.samsung.com/uk/support">www.samsung.com/uk/support</a>
IRELAND (EIRE)	0818 717100	<a href="http://www.samsung.com/ie/support">www.samsung.com/ie/support</a>
GERMANY	06196 77 555 66 *HHP 06196 77 555 77 *OTH	<a href="http://www.samsung.com/de/support">www.samsung.com/de/support</a>
FRANCE	01 48 63 00 00	<a href="http://www.samsung.com/fr/support">www.samsung.com/fr/support</a>
ITALIA	800-SAMSUNG (800.7267864)	<a href="http://www.samsung.com/it/support">www.samsung.com/it/support</a>
SPAIN	91 175 00 15	<a href="http://www.samsung.com/es/support">www.samsung.com/es/support</a>
PORTUGAL	808 207 267	<a href="http://www.samsung.com/pt/support">www.samsung.com/pt/support</a>
LUXEMBURG	261 03 710	<a href="http://www.samsung.com/be_fr/support">www.samsung.com/be_fr/support</a>
NETHERLANDS	088 90 90 100	<a href="http://www.samsung.com/nl/support">www.samsung.com/nl/support</a>
BELGIUM	02-201-24-18	<a href="http://www.samsung.com/be/support">www.samsung.com/be/support</a> (Dutch) <a href="http://www.samsung.com/be_fr/support">www.samsung.com/be_fr/support</a> (French)
NORWAY	21629099	<a href="http://www.samsung.com/no/support">www.samsung.com/no/support</a>
DENMARK	707 019 70	<a href="http://www.samsung.com/dk/support">www.samsung.com/dk/support</a>
FINLAND	030-6227 515	<a href="http://www.samsung.com/fi/support">www.samsung.com/fi/support</a>
SWEDEN	0771 726 786	<a href="http://www.samsung.com/se/support">www.samsung.com/se/support</a>
POLAND	801-172-678* lub +48 22 607-93-33* Specjalistyczna infolinia do obsługi zapytań dotyczących telefonów komórkowych: 801-672-678* * (opłata według taryfy operatora)	<a href="http://www.samsung.com/pl/support/">http://www.samsung.com/pl/support/</a>
HUNGARY	0680SAMSUNG (0680-726-7864)	<a href="http://www.samsung.com/hu/support">www.samsung.com/hu/support</a>
AUSTRIA	0800 72 67 864 (0800-SAMSUNG)	<a href="http://www.samsung.com/at/support">www.samsung.com/at/support</a>
SWITZERLAND	0800 726 78 64 (0800-SAMSUNG)	<a href="http://www.samsung.com/ch/support">www.samsung.com/ch/support</a> (German) <a href="http://www.samsung.com/ch_fr/support">www.samsung.com/ch_fr/support</a> (French)
CZECH	800 - SAMSUNG (800-726786)	<a href="http://www.samsung.com/cz/support">www.samsung.com/cz/support</a>
SLOVAKIA	0800 - SAMSUNG (0800-726 786)	<a href="http://www.samsung.com/sk/support">www.samsung.com/sk/support</a>
CROATIA	072 726 786	<a href="http://www.samsung.com/hr/support">www.samsung.com/hr/support</a>
BOSNIA	055 233 999	<a href="http://www.samsung.com/support">www.samsung.com/support</a>
MONTENEGRO	020 405 888	<a href="http://www.samsung.com/support">www.samsung.com/support</a>
SLOVENIA	080 697 267 (brezplačna številka)	<a href="http://www.samsung.com/si/support">www.samsung.com/si/support</a>
SERBIA	011 321 6899	<a href="http://www.samsung.com/rs/support">www.samsung.com/rs/support</a>
ALBANIA	045 620 202	<a href="http://www.samsung.com/al/support">www.samsung.com/al/support</a>
BULGARIA	*3000 Цена в мрежата 0800 111 31 , Безплатна телефонна линия	<a href="http://www.samsung.com/bg/support">www.samsung.com/bg/support</a>
ROMANIA	*8000 (apel in retea) 08008-726-78-64 (08008-SAMSUNG) Apel GRATUIT Atenție: Dacă efectuați apelul din rețeaua Digi (RCS/RDS), vă rugăm să ne contactați formând numărul Telverde fără ultimele două cifre, astfel: 0800872678.	<a href="http://www.samsung.com/ro/support">www.samsung.com/ro/support</a>
CYPRUS	8009 4000 only from landline, toll free	<a href="http://www.samsung.com/gr/support">www.samsung.com/gr/support</a>
GREECE	80111-SAMSUNG (80111 726 7864) only from land line (+30) 210 6897691 from mobile and land line	
LITHUANIA	8-800-77777	<a href="http://www.samsung.com/lt/support">www.samsung.com/lt/support</a>
LATVIA	8000-7267	<a href="http://www.samsung.com/lv/support">www.samsung.com/lv/support</a>
ESTONIA	800-7267	<a href="http://www.samsung.com/ee/support">www.samsung.com/ee/support</a>

