

**PUSH
YOUR
SKILL**

GO TO →

ZOTAC-CUP.COM

ZOTAC[®]
ZOTAC.COM

THE ORIGINAL
MINI PC

-  facebook.com/zotac
-  twitter.com/zotac
-  youtube.com/zotacofficial
-  vimeo.com/zotac



USER'S MANUAL

ZOTAC
ZBOX
PI335-GK

P SERIES

ZOTAC ZBOX pico User's Manual



No part of this manual, including the products and software described in it, may be reproduced, transmitted, transcribed, stored in a retrieval system, or translated into any language in any form or by any means, except by the purchaser for backup purposes, without the express written permission of ZOTAC.

Products and corporate names mentioned in this manual may be registered trademarks or copyrights of their respective companies, and are used for identification purposes only. All trademarks are the property of their respective owners.

Every effort has been made to ensure the contents of this manual are correct and up to date. However, the manufacturer makes no guarantee regarding the accuracy of its contents, and reserves the right to make changes without prior notice.

Table of Contents

Product specifications	3
Safety information	4
Setting up your system	4
Care during use	4
Welcome	5
Package contents	5
Port Layout	6
Mounting the ZOTAC ZBOX pico to an LCD monitor	8
Getting started with Windows 10 Pro	10
Using your ZOTAC ZBOX pico	14
Configuring a wireless connection	14
Configuring audio output via an HDMI device	14

Product specifications

Product Dimensions

- 115mm x 76mm x 20.7mm

Processor

- Intel Processor N4100 (quad-core, 1.1 GHz up to 2.4 GHz)

Graphics processor

- Intel UHD graphics 600
- HDMI 2.0 (max resolution: 3840X2160@60Hz)
- DP 1.2 (max resolution: 4096X2160@60Hz)

Memory

- 4 GB LPDDR4 memory

USB ports

- Two USB 3.0 ports
- One USB 3.0 Type-C port

Audio

- One combo headphone/microphone jack

Storage

- 64 GB eMMC
- 2-in-1 card reader (Micro SDHC/SDXC)

Networking

- 10/100/1000 Mbps Ethernet

Wireless networking

- 802.11ac Wi-Fi
- Bluetooth 5.0

Operating System

- Windows 10 Pro preinstalled

Safety information

Your ZOTAC ZBOX pico is designed and tested to meet the latest standards of safety for information technology equipment. However, to ensure your safety, it is important that you read the following safety instructions.

Setting up your system

- ❖ Read and follow all instructions in the documentation before you operate your system.
- ❖ Do not use this product near water or a heat source such as a radiator.
- ❖ Set up the system on a stable surface.
- ❖ Openings on the chassis are for ventilation. Do not block or cover these openings. Make sure you leave plenty of space around the system for ventilation. Never insert objects of any kind into the ventilation openings.
- ❖ Use this product in environments with ambient temperatures between 0°C and 35°C.

Care during use

- ❖ Do not walk on the power cord or allow anything to rest on it.
- ❖ Do not spill water or any other liquids on your system.
- ❖ When the system is turned off, a small amount of electrical current still flows. Always unplug all power, modem, and network cables from the power outlets before cleaning the system.
- ❖ If you encounter the following technical problems with the product, unplug the power cord and contact a qualified service technician or your retailer.
 - The power cord or plug is damaged.
 - Liquid has been spilled onto the system.
 - The system does not function properly even if you follow the operating instructions.
 - The system was dropped or the cabinet is damaged.

Welcome

Congratulations on your purchase of the ZOTAC ZBOX pico. The following illustration displays the package contents of your new ZOTAC ZBOX pico. Please contact your retailer if any of the below items are damaged or missed.

Package contents

- 1 x ZOTAC ZBOX pico
- 1 x Mounting bracket
- 2 x Mounting screws
- 1 x AC adapter
- 1 x CTIA<=>OMTP adapter
- 1 x OS Recovery USB Drive
- 1 x Warranty Card
- 1 x User Manual
- 1 x Quick Start Guide



Port Layout



1. Ethernet port

The eight-pin RJ-45 LAN port supports standard Ethernet cable for connection to a local network.

2. Combo Headphone/Microphone jack (3.5mm)

The combo headphone/microphone jack (3.5mm) is used to connect the system's audio out signal to amplified speakers, 3-pole headphones or 4-pole OMTP headphones.

Note: The combo headphone/microphone jack does not support the traditional microphone.

3. HDMI port

The HDMI (High Definition Multimedia Interface) port supports a UHD device such as an LCD TV or monitor to allow viewing on a larger external display.

4. DisplayPort

DisplayPort supports both external (box-to-box) and internal (laptop LCD panel) display connections.

5. USB 3.0 Type-C port

The USB 3.0 type-C port supports the SuperSpeed USB 3.0 devices. Use this port for USB 3.0 devices for maximum performance with USB 3.0 compatible devices.

6. Reset hole

Insert a pin into the reset hole for 3 seconds to clear CMOS.

7. MicroSD memory card slot

The built-in memory card reader supports Micro SDHC/SDXC cards to expand the storage capabilities of the ZOTAC ZBOX pico.

8. USB 3.0 ports

The USB 3.0 port supports SuperSpeed USB 3.0 devices and is backwards compatible with USB 2.0/1.1 devices. Use this port for USB 3.0 devices for maximum performance with USB 3.0 compatible devices.

9. Power input (DC 5V, 4A)

The supplied power adapter converts AC power to DC power for use with this jack. Power supplied through this jack supplies power to the mini-PC. To prevent damage to the mini-PC, always use the supplied power adapter.

10. Power LED

The Power LED is always ON when power is on.

11. Power button

The power button turns the system ON and OFF.

Note 1: The power adapter may get warm or hot when in use. Do not cover the adapter and keep it away from your body.
Note 2: Due to the unique design, some connectors are placed upside down.

Mounting the ZOTAC ZBOX pico to an LCD monitor

You can attach the ZOTAC ZBOX pico to the back of a VESA75/100 compliant display.

1. Secure the mounting bracket to the LCD monitor using 2 screws.
Disclaimer: ZOTAC is not liable for damages resulting from an improper installation.

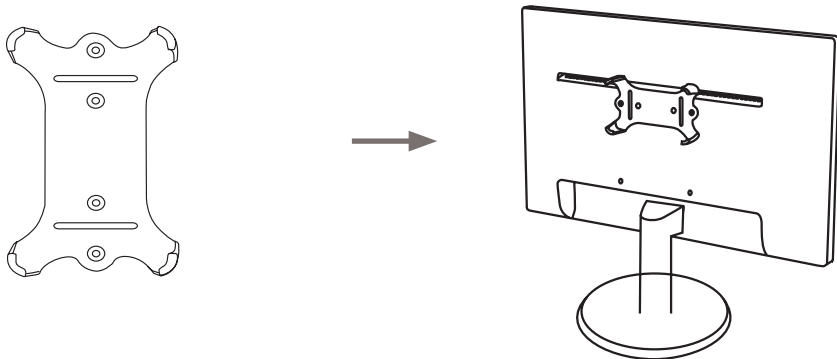

2. Attach the ZOTAC ZBOX pico to the VESA mount and gently press down to secure the ZBOX to the mount.

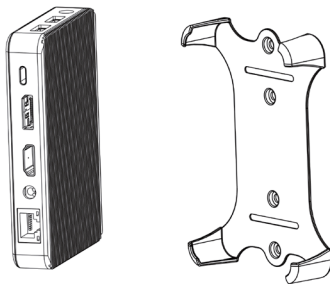

-
3. Connect the ZOTAC ZBOX pico to the LCD monitor with an HDMI cable.

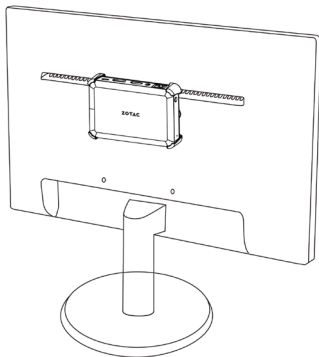

Note: You can also mount the ZOTAC ZBOX pico vertically as shown in the picture below.

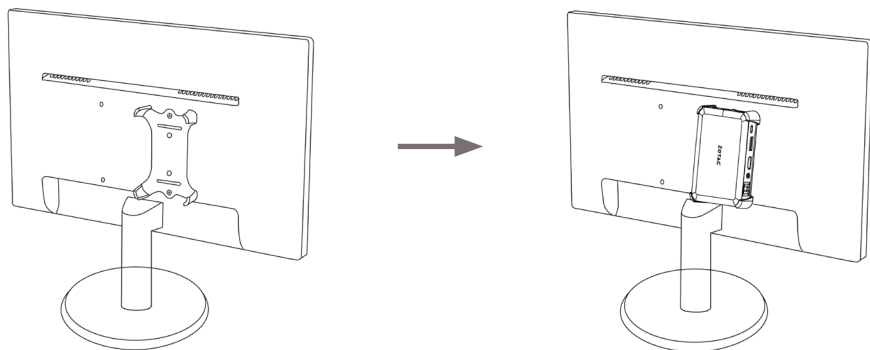

Getting started with Windows 10 Pro

Please follow the steps below to begin using your ZBOX pico with Windows 10 Pro.

1. Power on the system.
2. Connect to the Internet via Ethernet or Wi-Fi.
3. Select the language and region.

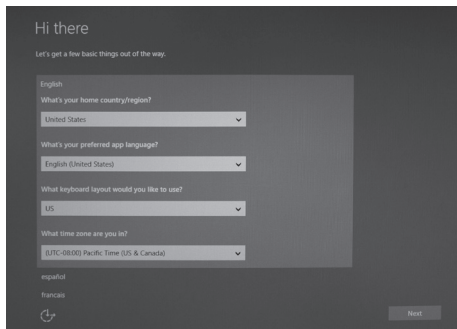
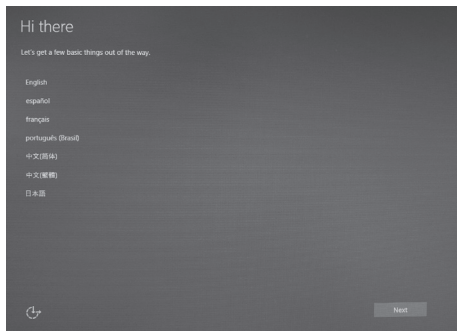

4. Read and accept the license terms.

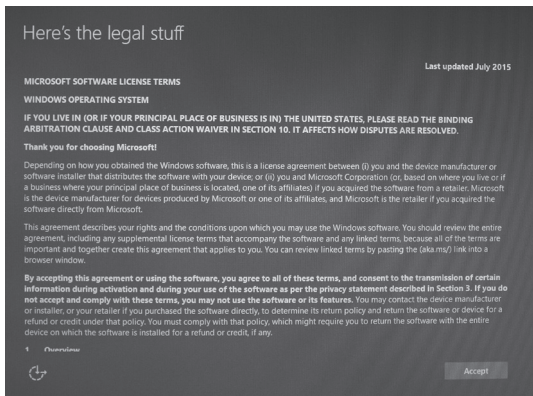

5. We recommend using the express settings.

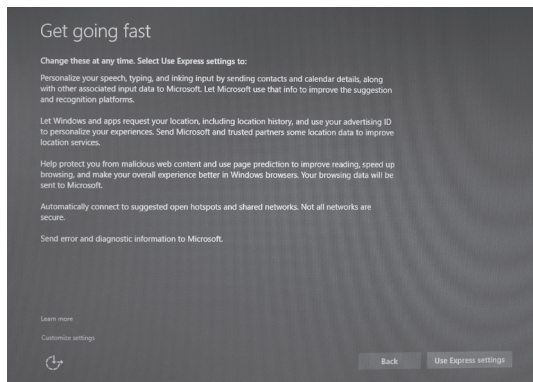

6. Create a Microsoft new account if you don't have one. Otherwise, select "Sign in".

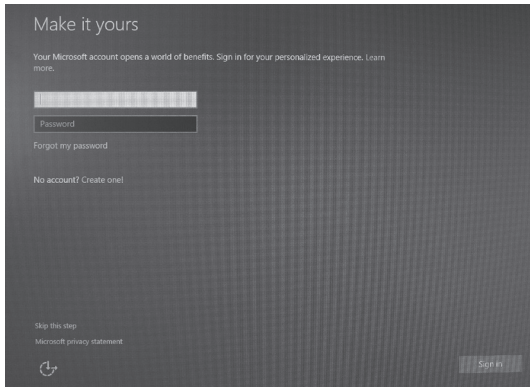

Make it yours

Your Microsoft account opens a world of benefits. Sign in for your personalized experience. Learn more.

[Forgot my password](#)

No account? [Create one!](#)

[Skip this step](#)

[Microsoft privacy statement](#)



7. Setup your account.

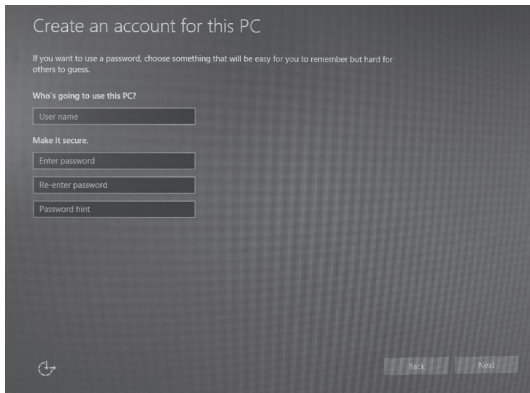

Create an account for this PC

If you want to use a password, choose something that will be easy for you to remember but hard for others to guess.

Who's going to use this PC?

Make it secure.



8. Wait for the initial system setup to complete .



We're setting things up for you



Taking care of a few things

Setting up your apps

Using your ZOTAC ZBOX pico

Configuring a wireless connection

Please follow the instructions below to connect to a wireless network:

1. Double-click the wireless network icon (pic) in the notification area.
2. Select the wireless network you want to connect to from the list and click Connect.
3. After connection is established, you will see “Connected.”

Note 1: For security concerns, Do NOT connect to an unsecured network, otherwise, the transmitted information without encryption might be visible to others.

Note 2: Enter the network security key if necessary.

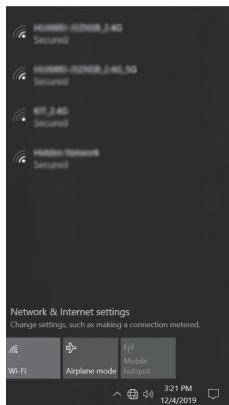

Configuring audio output via an HDMI device

Follow the steps below to enable audio output via HDMI when connecting the ZOTAC ZBOX pico to a TV or receiver via HDMI.

1. Access the Sound settings via the system Control Panel.
2. Under Playback devices, click the display device that corresponds with your HDMI audio compatible display
3. Click the “Set Default” button in the lower right hand corner.
4. Click “OK” to exit the setup.

