

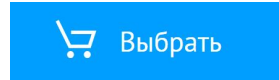

СТАРАЕТСЯ ДЛЯ МЕНЯ

Каталог телевизоров



Panasonic®

Model No.
TX-42CSR610

English

Operating Instructions LCD Television



VIERA

For more detailed instructions, refer to [eHELP]
(Built-in Operating Instructions).

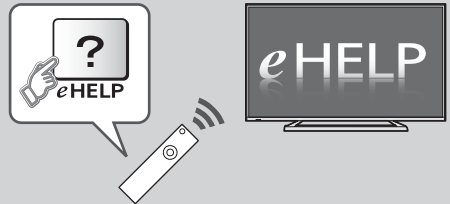

- How to use [eHELP] → (p. 14)

Thank you for purchasing this Panasonic product.

Please read these instructions carefully before operating this product and retain them for future reference.

Please carefully read the "Safety Precautions" of this manual before use.

The images shown in this manual are for illustrative purposes only.

Please refer to Pan European Guarantee Card if you need to contact your local Panasonic dealer for assistance.





- For the information of the trademarks, refer to [eHELP] (Support > Licence).

Contents

Be Sure to Read

Important Notice	3
Safety Precautions	3

Quick Start Guide

Accessories	5
Connections	7
Identifying Controls	10
First time Auto Setup	12

Using your VIERA

Operation	13
How to Use eHELP	14

Others

FAQs	15
Maintenance	16
Specifications	16

Important Notice

Notice for DVB / Data broadcasting / IPTV functions

- This TV is designed to meet the standards (as of August, 2014) of DVB-T / T2 (MPEG2 and MPEG4-AVC(H.264)) digital terrestrial services, DVB-C (MPEG2 and MPEG4-AVC(H.264)) digital cable services.
- Consult your local dealer for availability of DVB-T / T2 services in your area.
- Consult your cable service provider for availability of DVB-C services with this TV.
- This TV may not work correctly with the signal which does not meet the standards of DVB-T / T2 or DVB-C.
- Not all the features are available depending on the country, area, broadcaster, service provider and network environment.
- Not all CI modules work properly with this TV. Consult your service provider about the available CI module.
- This TV may not work correctly with CI module that is not approved by the service provider.
- Additional fees may be charged depending on the service provider.
- Compatibility with future services is not guaranteed.
- Check the latest information on the available services at the following website. (English only)
<http://panasonic.net/viera/support>

Panasonic does not guarantee operation and performance of peripheral devices made by other manufacturers; and we disclaim any liability or damage arising from operation and/or performance from usage of such other maker's peripheral devices.

This product is licensed under the AVC patent portfolio license for the personal and non-commercial use of a consumer to (i) encode video in compliance with the AVC Standard ("AVC Video") and/or (ii) decode AVC Video that was encoded by a consumer engaged in a personal and non-commercial activity and/or was obtained from a video provider licensed to provide AVC Video. No license is granted or shall be implied for any other use.

Additional information may be obtained from MPEG LA, LLC.

See <http://www.mpegla.com>.

Transport only in upright position

Class II

This product is designed for household watching TV programmes.

Safety Precautions







To help avoid risk of electrical shock, fire, damage or injury, please follow the warnings and cautions below:

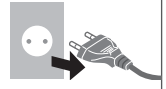

■ Mains plug and lead

Warning

If you detect anything unusual, immediately remove the mains plug.



- This TV is designed to operate on AC 220-240 V, 50 / 60 Hz.
 - Insert the mains plug fully into the mains socket.
 - Ensure that the mains plug is easily accessible.
 - Disconnect the mains plug when cleaning the TV.
 - Do not touch the mains plug with wet hands. 
 - Do not damage the mains lead.
 - Do not place a heavy object on the lead. 
 - Do not place the lead near a high temperature object. 
 - Do not pull on the lead. Hold onto the mains plug body when disconnecting the plug. 
 - Do not move the TV with the lead plugged into a mains socket.
 - Do not twist the lead, bend it excessively or stretch it.
 - Do not use a damaged mains plug or mains socket.
 - Ensure the TV does not crush the mains lead.
 - Do not use any mains lead other than that provided with this TV.
- ## ■ Take care
- ### Warning
- Do not remove covers and never modify the TV yourself as live parts are accessible when they are removed. There are no user serviceable parts inside. 
 - Do not expose the TV to rain or excessive moisture. This TV must not be exposed to dripping or splashing water and objects filled with liquid, such as vases, must not be placed on top of or above the TV. 
 - Do not insert foreign objects into the TV through the air vents. 

- Do not use an unapproved pedestal / mounting equipment. Be sure to ask your local Panasonic dealer to perform the setup or installation of approved wall-hanging brackets.
- Do not apply any strong force or impact to the display panel.
- Ensure that children do not climb on the TV.
- Do not place the TV on sloping or unstable surfaces, and ensure that the TV does not hang over the edge of the base. 
- This TV is designed for table-top use.
- Do not expose the TV to direct sunlight and other sources of heat. 

To prevent the spread of fire, keep candles or other open flames away from this product at all times



■ Suffocation / Choking Hazard

Warning

- The packaging of this product may cause suffocation, and some of the parts are small and may present a choking hazard to young children. Keep these parts out of reach of young children.

■ Pedestal

Warning

- Do not disassemble or modify the pedestal.

Caution

- Do not use any pedestal other than the one provided with this TV.
- Do not use the pedestal if it becomes warped or physically damaged. If this occurs, contact your nearest Panasonic dealer immediately.
- During setup, make sure that all screws are securely tightened.
- Ensure that the TV does not suffer any impact during installation of the pedestal.
- Ensure that children do not climb onto the pedestal.
- Install or remove the TV from the pedestal with at least two people.
- Install or remove the TV by the specified procedure.

■ Radio wave

Warning

- Do not use the TV in any medical institutions or locations with medical equipment. Radio waves may interfere with the medical equipment and may cause

accidents due to the malfunction.

- Do not use the TV near any automatic control equipment such as automatic doors or fire alarms. Radio waves may interfere with the automatic control equipment and may cause accidents due to the malfunction.
- Keep at least 22 cm away from the TV if you have a cardiac pacemaker. Radio waves may interfere with the operation of the pacemaker.
- Do not disassemble or alter the TV in any way.

■ Built-in wireless LAN

Caution

- Do not use the built-in wireless LAN to connect to any wireless network (SSID*) for which you do not have usage rights. Such networks may be listed as a result of searches. However, using them may be regarded as illegal access.

*SSID is a name for identifying a particular wireless network for transmission.

- Do not subject the built-in wireless LAN to high temperatures, direct sunlight or moisture.
- Data transmitted and received over radio waves may be intercepted and monitored.
- The built-in wireless LAN uses 2.4 GHz and 5 GHz frequency bands. To avoid malfunctions or slow response caused by radio wave interference when using the built-in wireless LAN, keep the TV away from other devices that use 2.4 GHz and 5 GHz signals such as other wireless LAN devices, microwave ovens, and mobile phones.
- When problems occur due to static electricity, etc., the TV might stop operating to protect itself. In this case, turn the TV off at the Mains power On / Off switch, then turn it back on.
- Additional information for the wireless LAN and access point may be on the following website. (English only)

<http://panasonic.net/viera/support>

■ Ventilation

Caution

Allow sufficient space around the TV in order to help prevent excessive heat, which could lead to early failure of some electronic components.

Minimum distance:

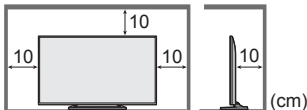

- Ventilation should not be impeded by covering the ventilation openings with items such as newspapers, tablecloths and curtains.



- Whether you are using a pedestal or not, always ensure the vents at the bottom of the TV are not blocked and there is sufficient space to enable adequate ventilation.

■ Moving the TV

Caution

Before moving the TV, disconnect all cables.

- Move the TV with at least two people.

■ When not in use for a long time

Caution

This TV will still consume some power even in the Off mode, as long as the mains plug is still connected to a live mains socket.

- Remove the mains plug from the wall socket when the TV is not in use for a prolonged period of time.

■ Excessive volume

Caution

- Do not expose your ears to excessive volume from the headphones. Irreversible damage can be caused.
- If you hear a drumming noise in your ears, turn down the volume or temporarily stop using the headphones.



■ Battery for the Remote Control

Caution

- Incorrect installation may cause battery leakage, corrosion and explosion.
- Replace only with the same or equivalent type.
- Do not mix old and new batteries.
- Do not mix different battery types (such as alkaline and manganese batteries).
- Do not use rechargeable batteries (Ni-Cd, etc.).
- Do not burn or break up batteries.
- Do not expose batteries to excessive heat such as sunshine, fire or the like.
- Make sure you dispose of batteries correctly.
- Remove the battery from the unit when not using for a prolonged period of time to prevent battery leakage, corrosion and explosion.

Accessories

Remote Control

- ➔ (p. 10)
- N2QAYB001009



Pedestal

- ➔ (p. 6)

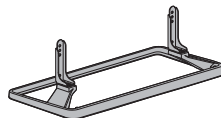

Mains lead

- ➔ (p. 7)

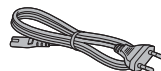

Batteries (2)

- R6
- ➔ (p. 11)



Operating Instructions

Warranty

- Accessories may not be placed all together. Take care not to throw them away unintentionally.
- For the information of optional accessories, refer to [eHELP] (Support > Optional accessories).

Assembling / Removing the pedestal

(A) Assembly screw (4)

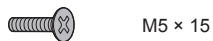

M5 x 15

(B) Assembly screw (4)



M4 x 12

(C) Bracket (2)



(D) Base

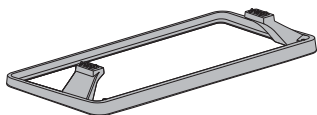

■ Assembling the pedestal

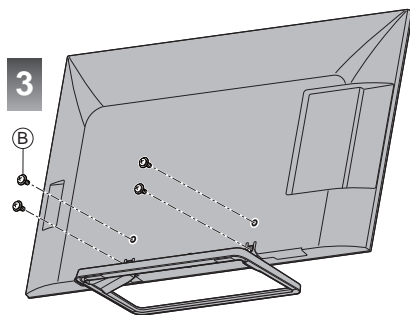
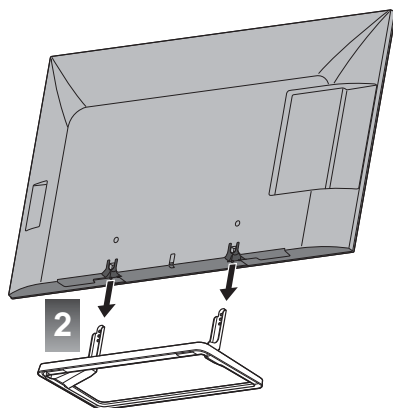
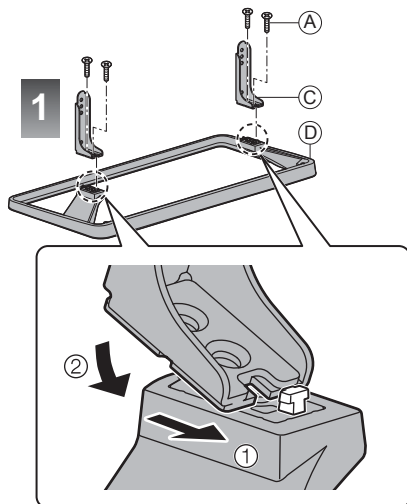

Removing the pedestal from the TV

Be sure to remove the pedestal in the following way when using the wall-hanging bracket or repacking the TV.

- 1 Remove the assembly screws (B) from the TV.
- 2 Pull out the pedestal from the TV.
- 3 Remove the assembly screws (A) from the bracket.

Connections

- External equipment and cables shown are not supplied with this TV.
- Please ensure that the unit is disconnected from the mains socket before attaching or disconnecting any cables.
- Check the terminal type and cable plugs are correct for connection.
- Use a fully wired HDMI compliant cable.
- Use a fully wired SCART cable.
- Keep the TV away from electronic equipment (video equipment, etc.) or equipment with an infrared sensor, otherwise distortion of image / sound may occur or operation of other equipment may be affected.
- Please also read the manual of the equipment being connected.

Terminals

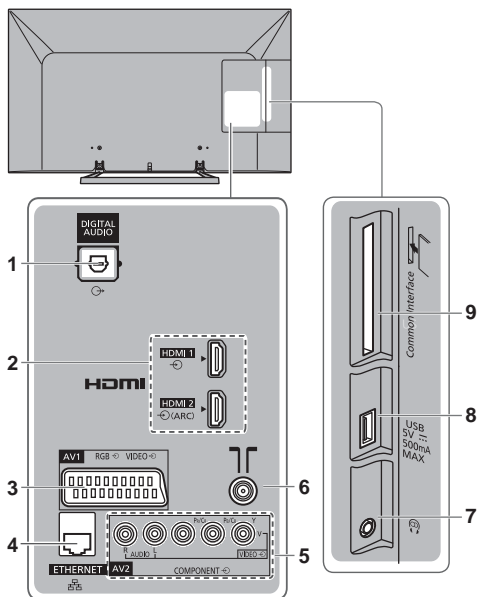

- 1 DIGITAL AUDIO
- 2 HDMI1 - 2 ➔ (p. 7, 8)
- 3 AV1 (SCART) ➔ (p. 8)
- 4 ETHERNET ➔ (p. 7, 8)
- 5 AV2 (COMPONENT / VIDEO) ➔ (p. 9)
- 6 Terrestrial / cable terminal
- 7 Headphone jack ➔ (p. 9)
- 8 USB port
- 9 CI slot ➔ (p. 9)

Basic connections

■ Mains lead

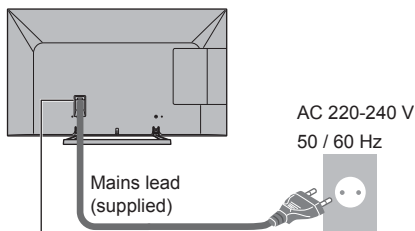

Insert the mains plug firmly into place.

- When disconnecting the mains lead, be absolutely sure to disconnect the mains plug from the mains socket first.

■ Aerial

TV

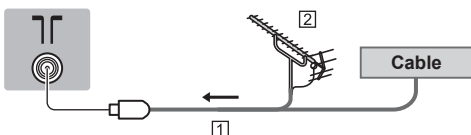

- 1 RF cable
 - 2 Terrestrial aerial
- For DVB-C, DVB-T, Analogue

DVB-via-IP client connection

This TV has DVB-via-IP client function and can connect to DVB-via-IP server to watch broadcast streaming.

- It is recommended to connect to DVB-via-IP server with a LAN cable.

■ Wired connection

TV

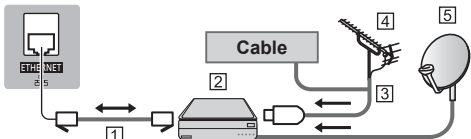

- 1 LAN cable (Shielded)
 - Use Shielded Twist Pair (STP) LAN cable.
- 2 DVB-via-IP server
- 3 RF cable
- 4 Terrestrial aerial
- 5 Satellite dish

■ Wireless connection

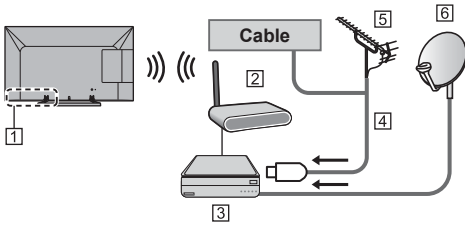

- 1 Built-in wireless LAN
- 2 Access point
- 3 DVB-via-IP server
- 4 RF cable
- 5 Terrestrial aerial
- 6 Satellite dish

- Depending on the network condition and broadcast, this function may not be available.
- For information about the connections, read the manual of the DVB-via-IP server.
- For details, refer to [eHELP] (Functions > DVB-via-IP).

AV devices

■ DVD Recorder / VCR

TV

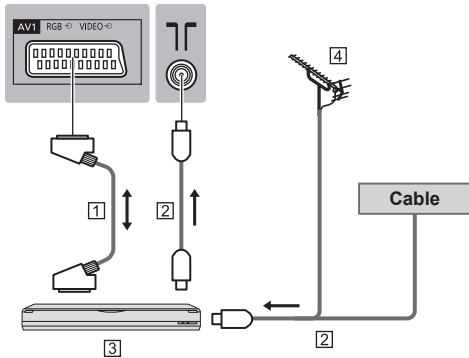

- 1 SCART cable
- 2 RF cable
- 3 DVD Recorder / VCR
- 4 Terrestrial aerial

■ DVD Recorder (VCR) / Set top box

TV

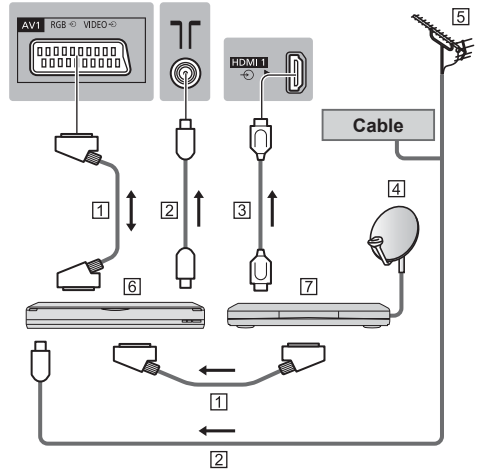

- 1 SCART cable
- 2 RF cable
- 3 HDMI cable
- 4 Satellite dish
- 5 Terrestrial aerial
- 6 DVD Recorder / VCR
- 7 Set top box

Network

A broadband network environment is required to be able to use internet services.

- If you do not have any broadband network services, please consult your retailer for assistance.
- Prepare the internet environment for wired connection or wireless connection.
- Setup of the network connection will start when first using the TV. ➔ (p. 12)

■ Wired connection

TV

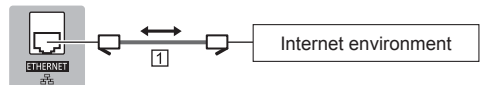

- 1 LAN cable (Shielded)
 - Use Shielded Twist Pair (STP) LAN cable.

■ Wireless connection



- 1 Built-in wireless LAN
- 2 Access point

Other connections

■ DVD Player

(COMPONENT equipment)

TV

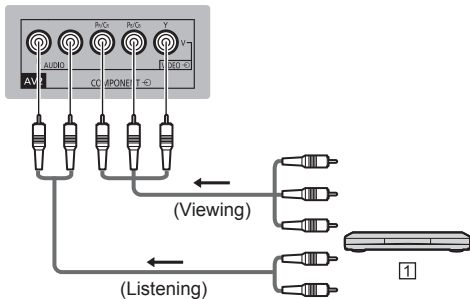

1 DVD Player

■ Camcorder / Game equipment

(VIDEO equipment)

TV

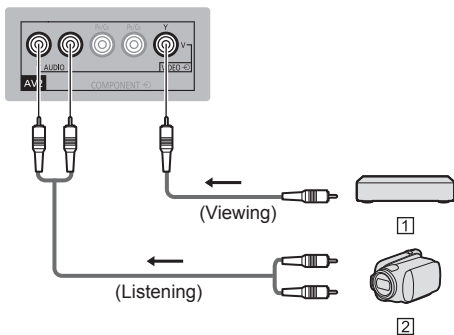

1 Camcorder / Game equipment

■ Amplifier (listening with external speakers)

- Use HDMI2 to connect the TV to an amplifier which has ARC (Audio Return Channel) function.

If connecting to an amplifier without ARC function, use DIGITAL AUDIO.

- To enjoy multi-channel sound from external equipment (e.g. Dolby Digital 5.1ch), connect the equipment to the amplifier. For information about the connections, read the manuals of the equipment and amplifier.

TV

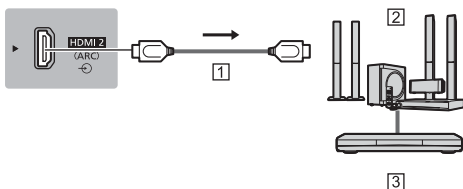

1 HDMI cable

2 Amplifier with speaker system

3 External equipment (DVD Player, etc.)

■ Headphones

- To adjust volume
 - ➔ [Headphone Volume] in the Sound Menu
- To select the sound output to adjust volume
 - ➔ [Speaker Setting] in the Sound Menu

TV



■ Common Interface

- Turn the TV off with Mains Power On / Off switch whenever inserting or removing the CI module.
- If a smart card and a CI module come as a set, first insert the CI module, then insert the smart card into the CI module.
- Insert or remove the CI module completely in the correct direction as shown.
- Normally encrypted channels will appear. (The viewable channels and its features depend on the CI module.)

If encrypted channels do not appear

➔ [Common Interface] in the Setup Menu

- There might be some CI modules in the market with older firmware versions that do not work fully interoperable with this new CI+ v1.3 TV. In this case, please contact your content provider.
- For more information, refer to [eHELP] (Functions > Common Interface), read the manual of the CI module, or check with the content provider.

TV

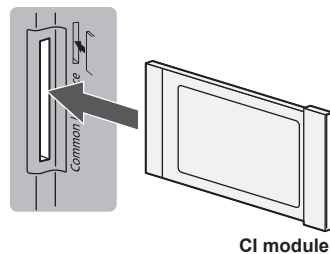

CI module

■ VIERA Link

- Use HDMI1 - 2 for VIERA Link connection.
- For more information, refer to [eHELP] (Functions > VIERA Link "HDAVI Control™").

Identifying Controls

Remote Control

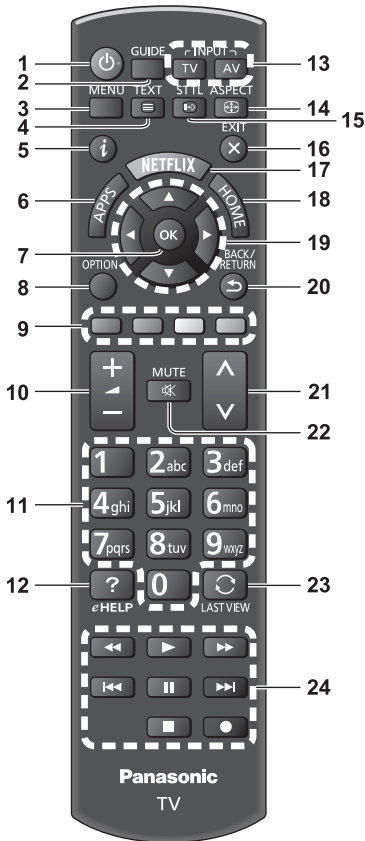

1 Standby On / Off switch

2 TV Guide

- Displays Electronic Programme Guide.

3 [Main Menu]

- Press to access Picture, Sound, Network, Timer, Setup and Help Menus, etc.

4 Teletext button

5 Information

- Displays channel and programme information.

6 APPS

- Displays [APPS List] (applications list).

7 OK

- Confirms selections and choices.
- Press after selecting channel positions to quickly change channel.

- Displays channel list.

8 [Option Menu]

- Easy optional setting for viewing, sound, etc.

9 Coloured buttons (red-green-yellow-blue)

- Used for the selection, navigation and operation of various functions.

10 Volume Up / Down

11 Numeric buttons

- Changes channel and teletext pages.
- Sets characters.
- When in Standby mode, switches TV on.

12 [eHELP]

- Displays [eHELP] (Built-in Operating Instructions).

13 Input mode selection

- TV - switches to DVB-C / DVB-T / DVB-via-IP/ Analogue.
- AV - switches to AV input mode from Input Selection list.

14 Aspect

- Changes aspect ratio.

15 Subtitles

- Displays subtitles.

16 Exit

- Returns to [Home Screen].

17 Netflix

- Accesses NETFLIX service directly.
- A broadband network environment is required to be able to use this function fully.
- This service may be stopped or changed without notice.

18 HOME

- Displays [Home Screen].

19 Cursor buttons

- Makes selections and adjustments.

20 Return

- Returns to the previous menu / page.

21 Channel Up / Down

22 Sound Mute On / Off

23 Last view

- Switches to previously viewed channel or input mode.

24 Operations for contents, connected equipment, etc.

■ Installing / Removing batteries

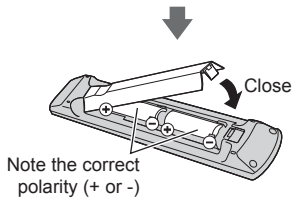
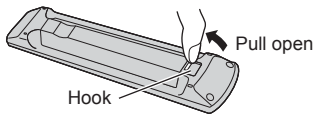

Indicator / Control panel

- When pressing 4, 5, 6 buttons, the control panel guide appears on the right side of the screen for 3 seconds to highlight which button has been pressed.

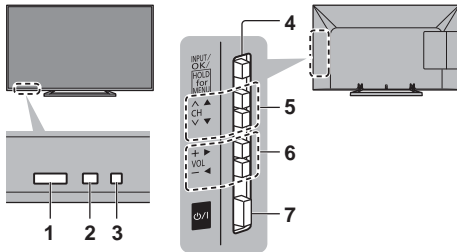

Rear side of the TV

1 Remote control signal receiver

- Do not place any objects between the TV remote control signal receiver and remote control.

2 Ambient sensor

- Senses brightness to adjust picture quality when [Ambient Sensor] in the Picture Menu is set to [On].

3 Power LED

Red: Standby

Green: On

- The LED blinks when the TV receives a command from the remote control.

4 Input mode selection

- Press repeatedly until you reach the desired mode.

[Main Menu]

- Press and hold for about 3 seconds to display main menu.

OK (when in the menu system)

5 Channel Up / Down

Cursor Up / Down (when in the menu system)

6 Volume Up / Down

Cursor Left / Right (when in the menu system)

7 Mains power On / Off switch

- Use to switch the mains power.

First time Auto Setup

When the TV is turned on for the first time, it will automatically search for available TV channels and give options to set up the TV.

- These steps are not necessary if the setup has been completed by your local dealer.
- Please complete connections (p. 7 - 9) and settings (if necessary) of the connected equipment before starting Auto Setup. For details of settings for the connected equipment, read the manual of the equipment.

1 Plug the TV into a live mains socket and turn the power on



- Takes a few seconds to be displayed.



2 Select the following items

Set up each item by following the on-screen instructions.

Example:

Please select your viewing environment.

Home

Shop

■ How to use the remote control



Move the cursor



Access the item / store the setting

BACK/
RETURN



Return to the previous item (if available)

Select the language

Select [Home]

Select [Home] for use in a home viewing environment.

- [Shop] is for shop display.
- To change the viewing environment later on, the set will need to have all settings initialised by accessing Shipping Condition.

Set up the network connection

Select your country

Tick the TV signal mode to tune, and then select [Start Auto Setup]

- : tune (search for the available channels)

: skip tuning

- Auto Setup screen varies depending on the country and the signal mode you select.

[DVB-C Network Settings]

Normally set [Frequency] and [Network ID] to [Auto].

If [Auto] is not displayed or if necessary, enter [Frequency] and [Network ID] specified by your cable provider with numeric buttons.

3 Select the type of [Home Screen]

The demonstration to explain how to use [my Home Screen] is displayed. Follow the demonstration by following the on-screen instructions, and then select the desired [Home Screen].

Example: [Home Screen Selection]



Example: [TV Home Screen]



Auto Setup is now complete and the TV is ready for viewing.

If tuning has failed check the RF cable, and the network connection, and then follow the on-screen instructions.

Note

- The TV goes into Standby mode when no operation is performed for 4 hours if [Auto Standby] in the Timer Menu is set to [On].
- The TV goes into Standby mode when no signal is received and no operation is performed for 10 minutes if [No signal Power off] in the Timer Menu is set to [On].
- To retune all channels
➔ [Auto Setup] in [Tuning Menu] (Setup Menu)
- To add the available TV signal mode later
➔ [Add TV Signal] in [Tuning Menu] (Setup Menu)
- To initialise all settings
➔ [Shipping Condition] in [System Menu] (Setup Menu)

Operation

Turn power on

⏻ (TV)

or

 (Remote Control)

- Mains power On / Off switch should be on. (p. 12)
The last viewed [Home Screen] is displayed.

Example: [TV Home Screen]

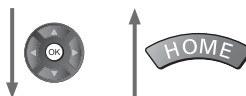

Example: Selected content screen



- To return to [Home Screen] at any time



- The [Home Screen] can be set up to display desired information, to access specific features easily, to select the default [Home Screen], etc. For details, follow the on-screen instructions or refer to [\[eHELP\]](#) (my Home Screen > my Home Screen).

Watching TV

1 Select the TV viewer from [Home Screen]



2 Select the mode

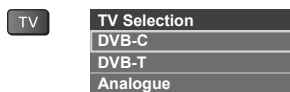

- The selectable modes vary depending on the channels stored.

3 Select a channel

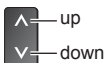

or



- To select a channel position with 2 or more-digit, e.g. 399



To access each feature

Access [APPS List] and select a feature



Example: [APPS List]



- APPS is the applications (features) of the TV.
- For operations of each feature and the setup of [APPS List], follow the on-screen instructions or refer to [\[eHELP\]](#) (my Home Screen > APPS List).

How to Use eHELP

[eHELP] is the detailed operating instructions built into the TV, and gives a more detailed explanation for a better understanding of the operation of each feature.

1 Display [eHELP]



eHELP

or

MENU



[Help]



[eHELP]

- If the [eHELP] has been accessed previously since the TV was turned on, the confirmation screen is displayed to select whether to go to the [First page] or to the [Last viewed page].

2 Select the category and item

Category field

Item field



Sub item field

Description

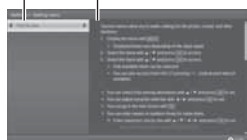

- To return to the previous field



- To scroll the description (if more than 1 page)

While the description is highlighted



- To display the menu related to the description (only for some descriptions)



(red)

FAQs

Before requesting service or assistance, please follow these simple guides to solve the problem.

- For more information, refer to [eHELP] (Support > FAQs).

The TV does not switch on

- Check the mains lead is plugged into the TV and the mains socket.

The TV goes into Standby mode

- Auto power standby function is activated.

The remote control does not work or is intermittent

- Are the batteries installed correctly? ➔ (p. 11)
- Has the TV been switched on?
- The batteries may be running low. Replace them with new ones.
- Point the remote control directly at the TV's remote control signal receiver (within about 7 m and a 30 degree angle of the signal receiver).
- Situate the TV away from sunshine or other sources of bright light so they do not shine on the TV's remote control signal receiver.

No image can be displayed

- Check the TV is turned on.
- Check the mains lead is plugged into the TV and the mains socket.
- Check the correct input mode is selected.
- Check the setting of [AV2] ([COMPONENT] / [VIDEO]) in [Input Selection] to match the output of the external equipment.
- Is [Backlight], [Contrast], [Brightness] or [Colour] in the Picture Menu set to the minimum?
- Check all required cables and connections are firmly in place.

Unusual image is displayed

- This TV has a built-in Self Test. Makes a diagnosis of picture or sound problems.
➔ **[TV Self Test] (Help Menu)**
- Turn the TV off with Mains power On / Off switch, then turn it on again.
- If the problem persists, initialise all settings.
➔ **[Shipping Condition] in [System Menu] (Setup Menu)**

Parts of the TV become hot

- Parts of the TV may become hot. These temperature rises do not pose any problems in terms of performance or quality.

When pushed with a finger, the display panel moves slightly and makes a noise

- There is a little gap around the panel to prevent damage to the panel. This is not a malfunction.

Maintenance

First, remove the mains plug from the mains socket.

Display panel, Cabinet, Pedestal

Regular care:

Gently wipe the surface of the display panel, cabinet, or pedestal by using a soft cloth to remove dirt or fingerprints.

For stubborn dirt:

- (1) First clean the dust from the surface.
- (2) Dampen a soft cloth with clean water or diluted neutral detergent (1 part detergent to 100 parts water).
- (3) Wring out the cloth firmly. (Please note, do not let liquid enter the TV inside as it may lead to product failure.)
- (4) Carefully wipe moisten and wipe away the stubborn dirt.
- (5) Finally, wipe away all the moisture.

Caution

- Do not use a hard cloth or rub the surface too hard, otherwise this may cause scratches on the surface.
- Take care not to subject the surfaces to insect repellent, solvent, thinner or other volatile substances. This may degrade surface quality or cause peeling of the paint.
- The surface of the display panel is specially treated and may be easily damaged. Take care not to tap or scratch the surface with your fingernail or other hard objects.
- Do not allow the cabinet and pedestal to make contact with a rubber or PVC substance for a long time. This may degrade surface quality.

Mains plug

Wipe the mains plug with a dry cloth at regular intervals. Moisture and dust may cause fire or electrical shock.

Specifications

■ TV

Model No.

TX-42CSR610

Rated power consumption

92 W

Standby power consumption*1

0.2 W

Dimensions (W × H*2 × D)

963 mm × 610 mm × 247 mm (With Pedestal)

963 mm × 566 mm × 69 mm (TV only)

Mass

10.5 kg Net (With Pedestal)

9.0 kg Net (TV only)

Power source

AC 220-240 V, 50 / 60 Hz

Display resolution

1 920 (W) × 1 080 (H)

Panel

LED LCD panel

Sound

Speaker output

20 W (10 W + 10 W)

Headphones

M3 (3.5 mm) stereo mini Jack × 1

Connection terminals

AV1 input / output

SCART (Audio/Video in, Audio/Video out, RGB in)

AV2 input (COMPONENT / VIDEO)

VIDEO

RCA PIN Type × 1

1.0 V[p-p] (75 Ω)

AUDIO L - R

RCA PIN Type × 2

0.5 V[rms]

Y

1.0 V[p-p] (including synchronisation)

PB, PR

±0.35 V[p-p]

HDMI 1 / 2 input

TYPE A Connectors

HDMI1: Content Type

HDMI2: Content Type, Audio Return Channel

- This TV supports "HDAVI Control 5" function.

Card slot

Common Interface slot (complies with CI Plus) × 1

ETHERNET

RJ45, IEEE802.3 10BASE-T / 100BASE-TX

USB Port

DC 5 V, Max. 500 mA [Hi-Speed USB (USB 2.0)]

DIGITAL AUDIO output

PCM / Dolby Digital / DTS, Fibre optic

Receiving systems / Band name

Check the latest information on the available services at the following website. (English only)

<http://panasonic.net/viera/support>

DVB-C

Digital cable services (MPEG2 and MPEG4-AVC(H.264))

DVB-T / T2

Digital terrestrial services (MPEG2 and MPEG4-AVC(H.264))

PAL D, K

SECAM D, K

VHF R1 - R2

VHF R3 - R5

VHF R6 - R12

UHF E21 - E69

PAL 525/60

Playback of NTSC tape from some PAL Video recorders (VCR)

M.NTSC

Playback from M.NTSC Video recorders (VCR)

NTSC (AV input only)

Playback from NTSC Video recorders (VCR)

Aerial input

VHF / UHF

Operating conditions

Temperature

0 °C - 35 °C

Humidity

20 % - 80 % RH (non-condensing)

Built-in wireless LAN

Standard compliance and Frequency range*2

IEEE802.11a/n

5.180 GHz - 5.320 GHz, 5.500 GHz - 5.580 GHz,
5.660 GHz - 5.700 GHz

IEEE802.11b/g/n

2.412 GHz - 2.472 GHz

Security

WPA2-PSK (TKIP/AES)

WPA-PSK (TKIP/AES)

WEP (64 bit/128 bit)

*1: when the TV is turned off with the remote control and no function is active

*2: The frequency and channel differ depending on the country. Follow the regulations of your country for the frequency range.

Note

- Design and Specifications are subject to change without notice. Mass and Dimensions shown are approximate.
- For the information of the open source software, refer to [eHELP] (Support > Licence).

■ When using the wall-hanging bracket

Please contact your local Panasonic dealer to purchase the recommended wall-hanging bracket.

- Holes for wall-hanging bracket installation

Rear of the TV

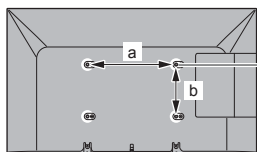

a: 200 mm

b: 200 mm

(View from the side)

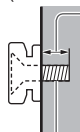

Depth of screw

minimum: 10 mm

maximum: 19 mm

Diameter: M6

Screw for fixing the TV onto the wall-hanging bracket (not supplied with the TV)



Information on Disposal in other Countries outside the European Union



This symbol is only valid in the European Union.

If you wish to discard this product, please contact your local authorities or dealer and ask for the correct method of disposal.

Declaration of Conformity

with the requirements of Technical Regulation on the Restriction Of the use of certain Hazardous Substances in Electrical and Electronic Equipment

(adopted by Order №1057 of Cabinet of Ministers of Ukraine)

The Product is in conformity with the requirements of Technical Regulation on the Restriction Of the use of certain Hazardous Substances in electrical and electronic equipment (TR on RoHS).

The content of hazardous substance with the exemption of the applications listed in the Annex №2 of TR on RoHS:

1. Lead (Pb) – not over 0,1wt % or 1000wt ppm;
2. Cadmium (Cd) – not over 0,01wt % or 100wt ppm;
3. Mercury (Hg) – not over 0,1wt % or 1000wt ppm;
4. Hexavalent chromium (Cr⁶⁺) – not over 0,1wt % or 1000wt ppm;
5. Polybrominated biphenyls (PBBs) – not over 0,1wt % or 1000wt ppm;
6. Polybrominated diphenyl ethers (PBDEs) – not over 0,1wt % or 1000wt ppm.

For Russia to be used Frequency Band 802.11abgn: (2400 - 2483.5) and / or (5150 - 5350 and 5650 - 5725) MHz

Информационный центр Panasonic
Для звонков из Москвы: +7 (495) 725-05-65
Бесплатный звонок по России: 8-800-200-21-00

Інфармацыйны цэнтр Panasonic
Для фіксаванай сувязі званок па тэрыторыі Беларусі бясплатны.
Бесплатный звонок со стационарных телефонов из Белоруссии: 8-820-007-1-21-00

Інформаційний центр Panasonic
Міжнародні дзвінки та дзвінки із Києва: +380-44-490-38-98
Безкоштовні дзвінки зі стаціонарних телефонів у межах України: 0-800-309-880

Panasonic ақпараттық орталығы
Қазақстан мен Орта Азиядан қоңырау шалу үшін.
Для звонков из Казахстана и Центральной Азии: +7 (7272) 98-09-09

Customer's Record

The model number and serial number of this product may be found on its rear panel. You should note this serial number in the space provided below and retain this book, plus your purchase receipt, as a permanent record of your purchase to aid in identification in the event of theft or loss, and for Warranty Service purposes.

Model Number

Serial Number

Panasonic Corporation

Web Site: <http://www.panasonic.com>

English

Обратите внимание!



Настенное крепление
для TV



3D-очки и
передатчики



Медиаплееры



Домашние
кинотеатры



Клавиатуры



Маршрутизаторы