

Washing Machine

OWNER'S MANUAL

PHILCO



Famous for Quality the World Over

PLD 106 E

**Dear customer,
Thank you for buying a PHILCO brand product. So that your appliance serves you well, please read all the instructions in this user's manual.**

CONTENTS

SAFETY INSTRUCTIONS	2
INSTALLATION.....	10
PRODUCT DESCRIPTION	10
INSTALLATION	11
OPERATIONS.....	15
QUICK START	15
BEFORE EACH WASHING	16
DETERGENT DISPENSER	16
CONTROL PANEL (PLD 106 E)	18
OPTION	18
OTHER FUNCTIONS	19
PROGRAMMES.....	21
WASHING PROGRAMMES TABLE.....	22
MAINTENANCES.....	23
CLEANING AND CARE.....	23
CLEANING THE INLET FILTER	24
CLEANING THE DRAIN PUMP FILTER	25
TROUBLE SHOOTING	26
TECHNICAL SPECIFICATIONS	27
PRODUCT INFORMATION SHEET	28

Read This Manual

Use all instructions and explanations of the installation before use. Follow the instructions carefully. Keep the operation instructions handy for later use. If the application is sold or passed on then ensure that the new owner always receives those operation instructions.

SAFETY INSTRUCTIONS

■ SAFETY INSTRUCTIONS

FOR YOUR SAFETY, THE INFORMATION IN THIS MANUAL MUST BE FOLLOWED TO MINIMIZE THE RISK OF FIRE OR EXPLOSION, ELECTRIC SHOCK, OR TO PREVENT PROPERTY DAMAGE, PERSONAL INJURY OR LOSS OF LIFE.

EXPLANATION OF THE SYMBOLS:

WARNING!

THIS COMBINATION OF SYMBOL AND SIGNAL WORD INDICATES A POTENTIALLY DANGEROUS SITUATION WHICH MAY RESULT IN DEATH OR SERIOUS INJURIES UNLESS IT'S AVOIDED.

CAUTION!

THIS COMBINATION OF SYMBOL AND SIGNAL WORD INDICATES A POTENTIALLY DANGEROUS SITUATION WHICH MAY RESULT IN SLIGHT OR MINOR INJURIES OR DAMAGE TO PROPERTY AND THE ENVIRONMENT.

NOTE!

THIS COMBINATION OF SYMBOL AND SIGNAL WORD INDICATES A POTENTIALLY DANGEROUS SITUATION WHICH MAY RESULT IN SLIGHT OR MINOR INJURIES.

 WARNING!

THIS APPLIANCE CAN BE USED BY CHILDREN AGED FROM 8 YEARS AND ABOVE AND BY PERSONS WITH REDUCED PHYSICAL, SENSORY OR MENTAL CAPABILITIES OR LACK OF EXPERIENCE AND KNOWLEDGE IF THEY HAVE BEEN GIVEN SUPERVISION OR INSTRUCTIONS CONCERNING SAFE USE OF THE APPLIANCE AND IF THEY UNDERSTAND THE HAZARDS INVOLVED.

CHILDREN MUST NOT PLAY WITH THE APPLIANCE.

CHILDREN UNDER 3 YEARS OF AGE SHOULD BE PREVENTED FROM ACCESSING THE APPLIANCE UNLESS THEY ARE UNDER PERMANENT SUPERVISION.

CLEANING AND USER MAINTENANCE CANNOT BE PERFORMED BY CHILDREN WITHOUT SUPERVISION.

IF THE SUPPLY CORD IS DAMAGED, HAVE IT REPLACED BY A QUALIFIED SERVICE CENTRE IN ORDER TO AVOID DANGEROUS SITUATIONS. IT IS PROHIBITED TO USE AN APPLIANCE WITH A DAMAGED SUPPLY CORD.

THE MAXIMUM WEIGHT OF DRY TEXTILES THAT CAN BE USED WITH THE APPLIANCE IS 6 KG.

THE VENTS IN BOTTOM THE OF THE DRYER SHOULD NOT BE COVERED BY A CARPET.

THIS APPLIANCE IS INTENDED TO BE USED ONLY IN HOUSEHOLDS AND NOT IN SIMILAR PREMISES, SUCH AS:

- KITCHENETTES IN SHOPS, OFFICES AND OTHER WORKPLACES;
- APPLIANCES USED APPLIANCES USED BY GUESTS IN HOTELS, MOTELS, AND OTHER ACCOMMODATION FACILITIES;
- APPLIANCES USED IN BED AND BREAKFAST FACILITIES;
- APPLIANCES USED IN CATERING AND OTHER SIMILAR NON-VENDING ENVIRONMENTS

THIS APPLIANCE IS INTENDED FOR WASHING FABRICS FOR WHICH THE MANUFACTURER HAS RECOMMENDED SUCH TREATMENT.

ALWAYS USE PROGRAMMES ACCORDING TO THE FABRIC TYPE. THE WASHING MACHINE MIGHT GET DAMAGED WHEN WASHING SHOES.

DO NOT USE TO WASH CARPETS.

USE ONLY DETERGENTS THAT ARE INTENDED FOR WASHING OR DRYING CLOTHES IN AN AUTOMATIC DRUM WASHING MACHINE.

SOFTENERS AND SIMILAR PRODUCTS SHOULD ALWAYS BE USED IN ACCORDANCE WITH THEIR INSTRUCTION FOR USE.



- IF THE SUPPLY CORD GETS DAMAGED, IT MUST BE REPLACED BY THE MANUFACTURER, ITS SERVICE AGENT OR OTHER SIMILARLY QUALIFIED PERSON.

- THE APPLIANCE SHOULD ONLY BE CONNECTED TO THE WATER SUPPLY AND THE DRAIN USING NEW HOSES, NOT USING HOSES THAT HAVE ALREADY BEEN USED.
- THE APPLIANCE SHOULD BE DISCONNECTED FROM THE MAINS BEFORE ANY MAINTENANCE.
- THE POWER CORD PLUG MUST BE CONNECTED TO A GROUNDED THREE-POLE ELECTRIC OUTLET.
- NEVER USE A POWER OUTLET WITH A RATED VOLTAGE THAT IS DIFFERENT FROM THE APPLIANCE'S VOLTAGE.
- DO NOT USE AN EXTENSION CORD TO CONNECT THE APPLIANCE TO THE POWER OUTLET.
- THE APPLIANCE, THE POWER CORD OR THE ELECTRIC OUTLET MUST NOT LIE IN, TOUCH OR BE SUBMERGED IN WATER OR ANY OTHER LIQUID TO AVOID ELECTRICAL HAZARDS.
- THE APPLIANCE MUST NOT STAND ON THE POWER CORD.
- THE POWER CORD MUST NOT BE EXCESSIVELY OR DANGEROUSLY BENT OR COMPRESSED DURING INSTALLATION OR OPERATION.
- THE CONTROLS AND THE DOOR OF THE APPLIANCE ARE NOT INTENDED FOR PLAYING.
- PETS OR CHILDREN COULD CRAWL INTO THE APPLIANCE. THE APPLIANCE SHOULD BE CHECKED BEFORE EACH USE.
- THE GLASS DOOR OF THE APPLIANCE CAN GET HOT DURING OPERATION.
- MAKE SURE THE CHILDREN AND PETS ARE AS FAR AWAY FROM THE APPLIANCE AS POSSIBLE DURING THE OPERATION OF THE APPLIANCE.
- REMOVE ALL PACKAGING MATERIALS AND TRANSPORTATION BOLTS BEFORE USING THE APPLIANCE. OTHERWISE IT MIGHT GET SERIOUSLY DAMAGED.

- DO NOT WASH OR DRY ITEMS THAT HAVE BEEN CLEANED, WASHED, STAINED OR SOAKED IN FLAMMABLE OR EXPLOSIVE SUBSTANCES (SUCH AS WAX, OIL, PAINT, GASOLINE, DEGREASING AGENTS, DRY CLEANING SUBSTANCES, PETROLEUM, ETC.). THIS COULD CAUSE A FIRE OR AN EXPLOSION. THOSE ITEMS SHOULD BE WASHED IN HAND BEFORE USING THEM IN THE APPLIANCE.

APPLIANCE INSTALLATION

- THIS APPLIANCE IS INTENDED FOR INTERIOR USE ONLY.
- THIS APPLIANCE IS NOT INTENDED TO BE USED AS A BUILT-IN APPLIANCE.
- THE ELECTRIC OUTLET THAT THE POWER CORD IS CONNECTED TO MUST BE EASILY ACCESSIBLE AFTER THE APPLIANCE HAS BEEN INSTALLED.
- REMOVE ALL PACKAGING MATERIALS AND SAFETY TRANSPORTATION BOLTS BEFORE USING THE APPLIANCE. OTHERWISE THE APPLIANCE OR ITS SURROUNDINGS MIGHT GET SERIOUSLY DAMAGED.
- THE APPLIANCE, THE POWER CORD OR THE ELECTRIC OUTLET MUST NOT LIE IN, TOUCH OR BE SUBMERGED IN WATER OR ANY OTHER LIQUID TO AVOID ELECTRICAL HAZARDS.
- DISPOSE OF PACKAGING IN A PROPER MANNER.
- DO NOT LIFT OR HANDLE THE APPLIANCE WHEN HOLDING ITS DOOR, CONTROLS, THE UPPER BOARD, HOSES OR POWER CORD.
- THE APPLIANCE MUST BE PLACED ON A FIRM AND LEVEL SURFACE.
- AFTER YOU PLACE THE APPLIANCE, MAKE SURE IT IS LEVEL IN ALL DIRECTIONS USING A SPIRIT LEVEL.
- THE WASHING MACHINE MUST NOT BE INSTALLED IN A BATHROOM OR IN VERY DAMP AREAS, OR IN ROOMS WITH EXPLOSIVE OR CORROSIVE GASES.

- A WASHING MACHINE WITH A SINGLE SUPPLY VALVE MAY ONLY BE CONNECTED TO COLD WATER SUPPLY. IF POSSIBLE, AN APPLIANCE WITH TWO SUPPLY VALVES SHOULD BE CONNECTED TO THE HOT WATER SUPPLY AND THE COLD WATER SUPPLY.

**THESE SAFETY INSTRUCTIONS SHOULD BE READ
AND FOLLOWED CAREFULLY AND KEPT FOR FUTURE
REFERENCE.**

RISK OF DAMAGING APPLIANCE!

- YOUR PRODUCT IS ONLY FOR HOME USE AND IS ONLY DESIGNED FOR THE TEXTILES SUITABLE FOR MACHINE WASHING.
- DO NOT CLIMB UP AND SIT ON TOP COVER OF THE MACHINE.
- DO NOT LEAN AGAINST MACHINE DOOR.
- CAUTIONS DURING HANDLING MACHINE:
 1. TRANSPORT BOLTS SHALL BE REINSTALLED TO THE MACHINE BY A SPECIALIZED PERSON.
 2. THE ACCUMULATED WATER SHALL BE DRAINED OUT OF THE MACHINE.
 3. HANDLE THE MACHINE CAREFULLY. NEVER HOLD EACH PROTRUDED PART ON THE MACHINE WHILE LIFTING. MACHINE DOOR CAN NOT BE USED AS THE HANDLE DURING THE CONVEYANCE.
 4. THIS APPLIANCE IS HEAVY. TRANSPORT WITH CARE.
- PLEASE DO NOT CLOSE THE DOOR WITH EXCESSIVE FORCES. IF IT IS FOUND DIFFICULT TO CLOSE THE DOOR, PLEASE CHECK IF THE CLOTHES ARE PUT IN OR DISTRIBUTED WELL.
- IT IS FORBIDDEN TO WASH CARPETS.

OPERATING THE APPLIANCE

- BEFORE WASHING THE CLOTHES AT FIRST TIME, THE PRODUCT SHALL BE OPERATED IN ONE ROUND OF THE WHOLE PROCEDURES WITHOUT THE CLOTHES INSIDE.
- FLAMMABLE AND EXPLOSIVE OR TOXIC SOLVENTS ARE FORBIDDEN. GASOLINE AND ALCOHOL ETC. SHALL NOT BE USED AS DETERGENTS. PLEASE ONLY SELECT THE DETERGENTS SUITABLE FOR MACHINE WASHING, ESPECIALLY FOR DRUM.
- MAKE SURE THAT ALL POCKETS ARE EMPTIED. SHARP AND RIGID ITEMS SUCH AS COIN, BROOCH, NAIL, SCREW OR STONE ETC. MAY CAUSE SERIOUS DAMAGES TO THIS MACHINE.
- PLEASE CHECK WHETHER THE WATER INSIDE THE DRUM HAS BEEN DRAINED BEFORE OPENING ITS DOOR. PLEASE DO NOT OPEN THE DOOR IF THERE IS ANY WATER VISIBLE.
- BE CAREFUL OF BURNING WHEN THE PRODUCT DRAINS HOT WASHING WATER.
- NEVER REFILL THE WATER BY HAND DURING WASHING.
- AFTER THE PROGRAM IS COMPLETED, PLEASE WAIT FOR TWO MINUTES TO OPEN THE DOOR.

PACKAGING/OLD APPLIANCE



THIS MARKING INDICATES THAT THIS PRODUCT SHOULD NOT BE DISPOSED WITH OTHER HOUSEHOLD WASTES THROUGHOUT THE EU. TO PREVENT POSSIBLE HARM TO THE ENVIRONMENT OR HUMAN HEALTH FROM UNCONTROLLED WASTE DISPOSAL, RECYCLE IT RESPONSIBLY TO PROMOTE THE SUSTAINABLE REUSE OF MATERIAL RESOURCES. TO RETURN YOUR USED DEVICE, PLEASE USE THE COLLECTION SYSTEMS OR CONTACT THE RETAILER WHERE THE PRODUCT WAS PURCHASED. THEY RETURN AND CAN TAKE THIS PRODUCT FOR ENVIRONMENTAL SAFE RECYCLING.

INSTALLATION

■ Product Description

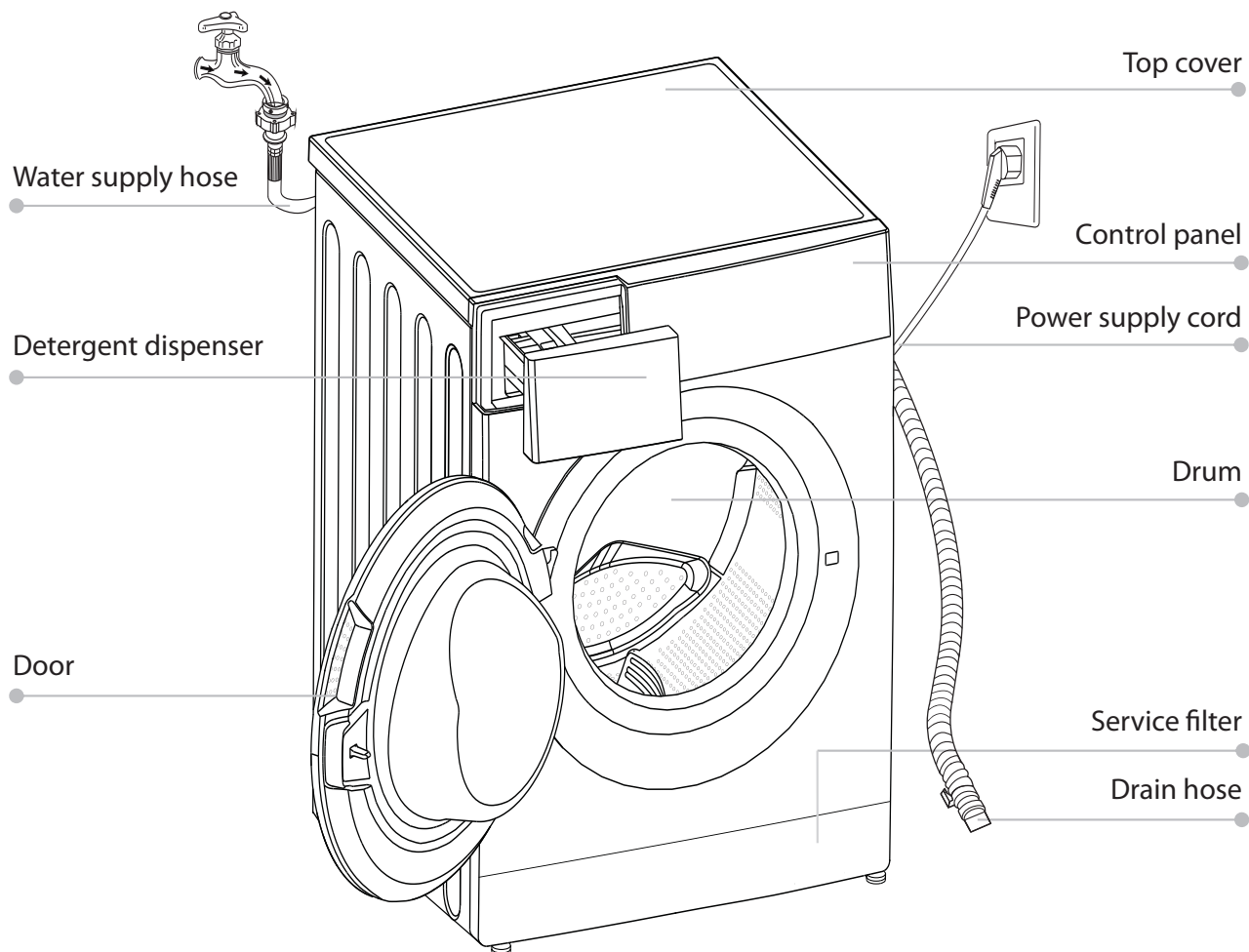

Note!

- The product line chart is for reference only, please refer to real product as standard.

Accessories



Transport hole plug

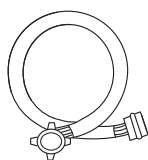

Supply hose cold water

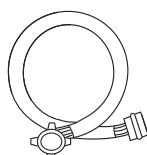

Supply hose hot water (optional)

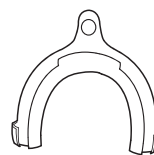

Drain hose support (optional)



Owner's manual

■ Installation

Installation area

Warning!

- Stability is important to prevent the product from wandering!
- Make sure that the product should not stand on the power cord.

Before installing the machine, the location characterized as follows shall be selected:

1. Rigid, dry, and level surface
2. Avoid direct sunlight
3. Sufficient ventilation
4. Room temperature is above 0°C
5. Keep far away from the heat resources such as coal or gas.

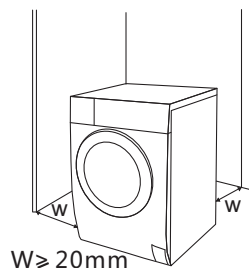

Unpacking the washing machine

Warning!

- Packaging material (e.g. Films, Styrofoam) can be dangerous for children.
- There is a risk of suffocation | Keep all packaging well away from children.

1. Remove the cardboard box and styrofoam packing.
2. Lift the washing machine and remove the base packing. Make sure the small triangle foam is removed with the bottom one together. If not, lay the unit down with side surface, then remove the small foam from the unit bottom manually.
3. Remove the tape securing the power supply cord and drain hose.
4. Remove the inlet hose from the drum.

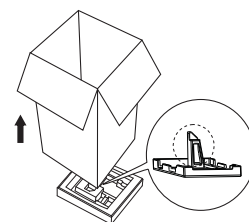

Remove transport bolts

Warning!

- You must remove the transport bolts from the backside before using the product.
- You'll need the transport bolts again if you move the product, so make sure you keep them in a safe place.

Please take the following steps to remove the bolts:

1. Loosen 4 bolts with spanner and then remove them.
2. Stop the holes with transport hole plugs.
3. Keep the transport bolts properly for future use.

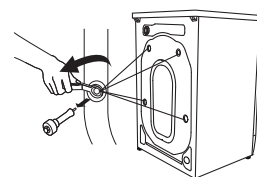

Levelling the washing machine

Warning!

- The lock nuts on all four feet must be screwed tightly against the housing.

1. Check if the legs are closely attached to the cabinet. If not, please turn them to their original positions tighten the nuts.
2. Loosen the lock nut turn the feet until it closely contacts with the floor.
3. Adjust the legs and lock them with a spanner, make sure the machine is steady.

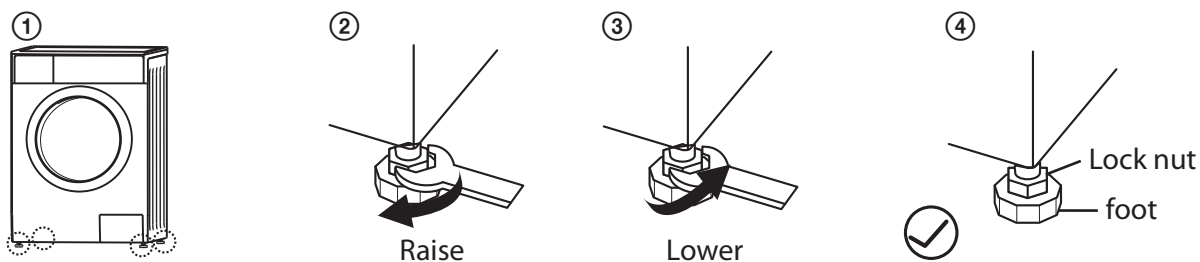

Connect Water Supply Hose

Warning!

- To prevent leakage or water damage, follow the instructions in this chapter!
- Do not kink, crush, modify or sever water inlet hose.
- For the model equips hot valve, connect it to hot water tap with hot water supply hose. Energy consumption will decrease automatically for some program.

Connect the inlet pipe as indicated, There are two ways to connect the inlet pipe.

1. Connection between ordinary tap and inlet hose.

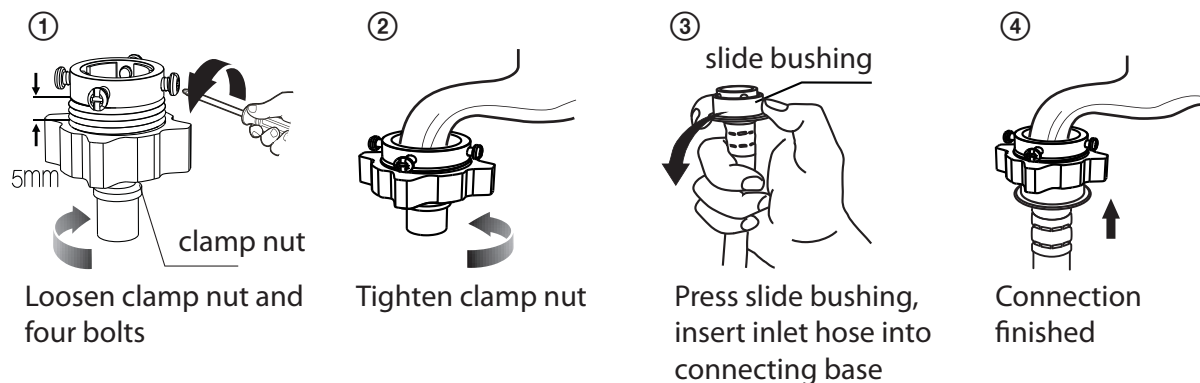

2. Connection between screw tap and inlet hose.



Connect the other end of inlet pipe to the inlet valve at the backside of product and fasten the pipe tightly clockwise.

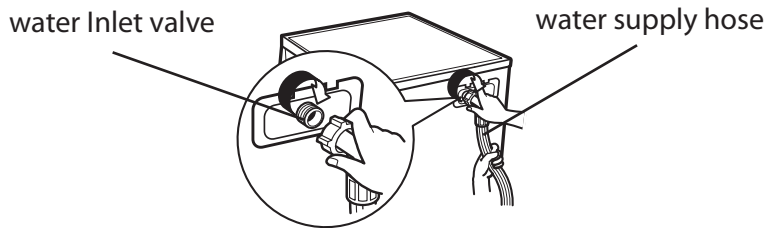

Drain Hose

Warning!

- Do not kink or protract the drain hose.
- Position drain hose properly .otherwise damage might result of water leakage.

There are two ways to place the end of drain hose:

1. Put it into the water trough.

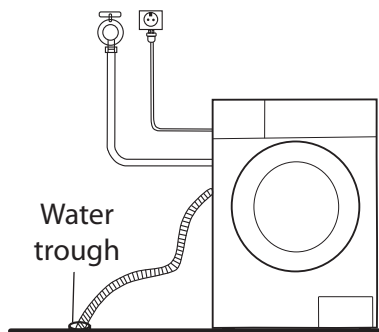

2. Connect it to the branch drain pipe of the trough.

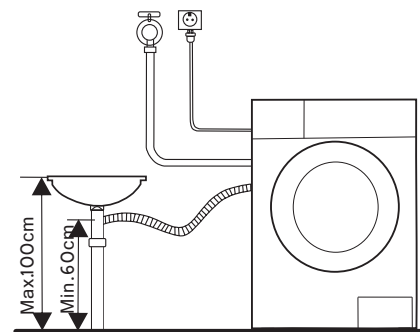

Note!

- If the machine has drain hose support, please install it like the following.

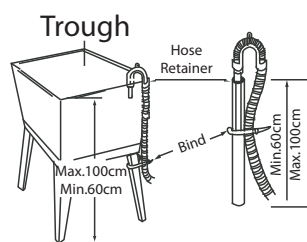
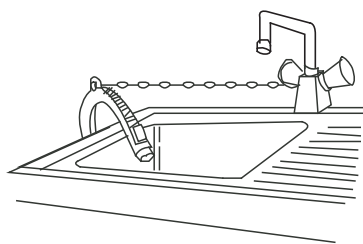

⚠ Warning!

- When installing drain hose, fix it properly with a rope.
- If drain hose is too long, do not force it into washing machine as it will cause abnormal noises.

OPERATIONS

■ Quick Start

⚠ Caution!

- Before washing, please make sure it's installed properly.
- Before washing at first time, the washing machine shall be operated in one round of the whole procedures without clothes in as follows.

1. Before Washing

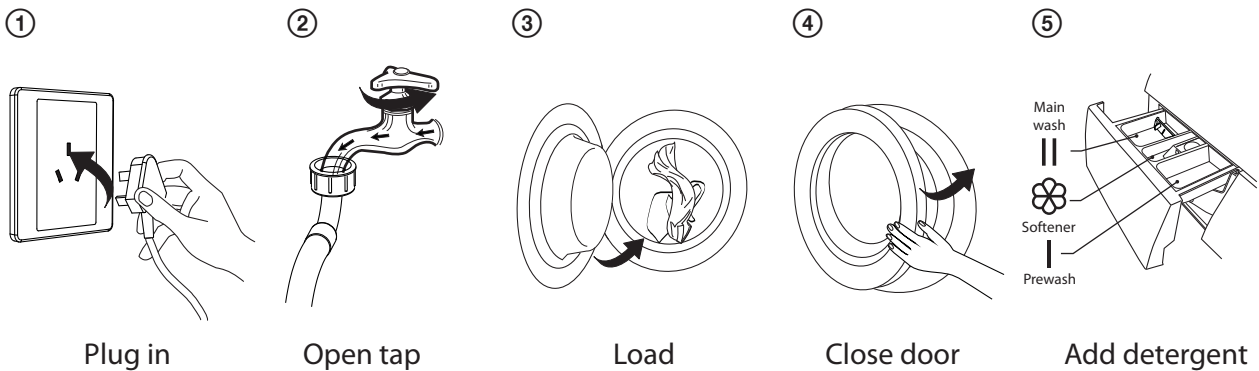

📌 Note!

- Detergent need to be added in "case I" after selecting pre-washing for machines with this function.

2. Washing

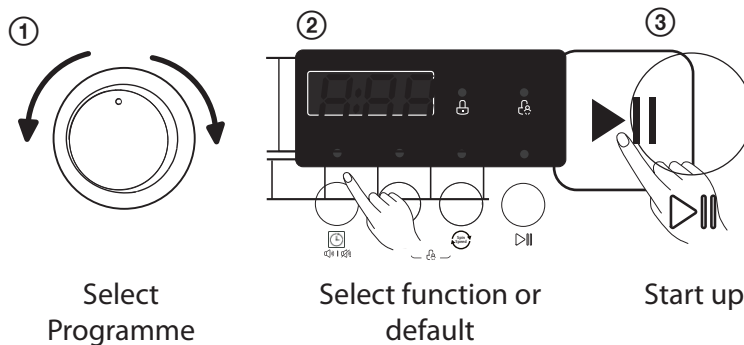

📌 Note!

- If default is selected, step 2 can be skipped.
- 2.The function button line chart is for reference only, please refer to real product as standard.

3. After Washing

The door lock and the [Start / Pause] lights flash with the buzzer beeping or two small points flash on the digital screen.

■ Before Each Washing

- The working condition of the washer should be (0-40)°C. If used under 0°C, the inlet valve and draining system may be damaged. If the machine is placed under condition of 0°C or less, then it should be transferred to normal ambient temperature to ensure the water supply hose and drain hose are not frozen before use.
- Please check the labels and the explanation of using detergent before wash. Use non-foaming or less-foaming detergent suitable for machine washing properly.

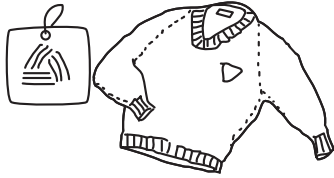

Check the label

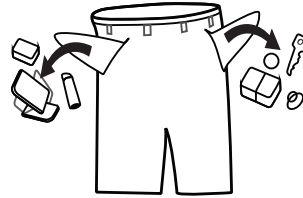

Take out the items out of the pockets



Knot the long strips, zip or button

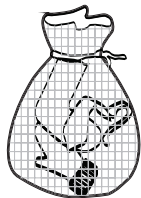

Put small clothes into the pillow slip

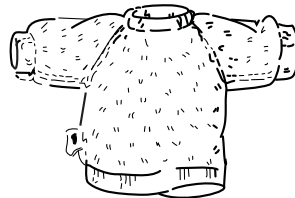

Turn easy-pilling and long-pile fabric inside out

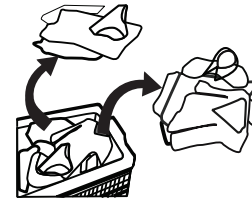

Separate clothes with different textures

⚠ Warning!

- When washing a single clothes, it may easily cause great eccentricity and give alarm due to great unbalance. Therefore it is suggested to add one or two more clothes to be washed together so that draining can be done smoothly.
- Don't washing the clothes touching with kerosene, gasoline, alcohol and other flammable materials.

■ Detergent Dispenser

- I Pre Wash detergent
- II Main Wash detergent
- ☼ Softener

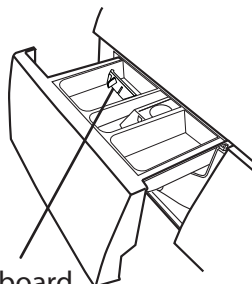

Dam-board
Liquid detergent

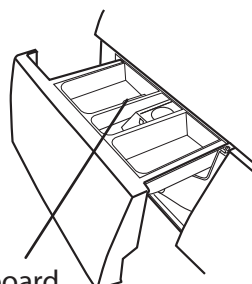

Dam-board
Powder detergent

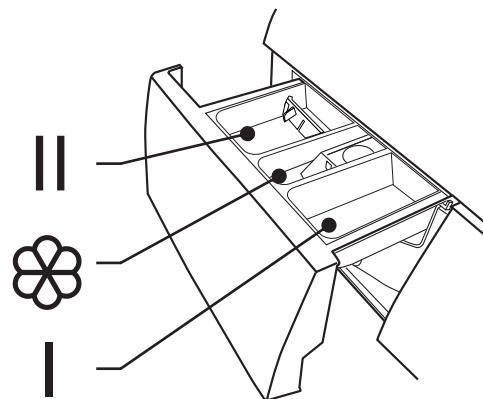

Pull out the dispenser

 **Caution!**

- Detergent only need to be added in „case I“ after selecting pre-washing for machines with this function.

Programme	I	II	
Cotton 30 °C		●	○
Cotton 40 °C		●	○
Cotton 60 °C		●	○
Cotton 90 °C		●	○
Synthetic		●	○
Synthetic 40 °C		●	○
Drum Clean			
Cotton Intensive 40 °C		●	○
Cotton Intensive 60 °C		●	○
Quick Wash 45´		●	○
Quick Wash 30´		●	○
Quick Wash 15´		●	○

Programme	I	II	
Spin Only			
Drain Only			
Rinse & Spin			○
Delicate 30 °C		●	○
Delicate		●	○
Mix 60 °C		●	○
Mix 40 °C		●	○
Mix		●	○
ECO 40-60		●	○
Cold Wash		●	○
Cold Wash 20 °C		●	○

● Means must ○ Means optional

 **Note!**

- As for the agglomerated or ropy detergent or additive, before they are poured into the detergent box, it is suggested to use some water for dilution to prevent the inlet of detergent box from being blocked and overflowing while filling water.
- Please choose suitable type of detergent for the various washing temperature to get the best washing performance with less water and energy consumption.

■ Control Panel (PLD 106 E)

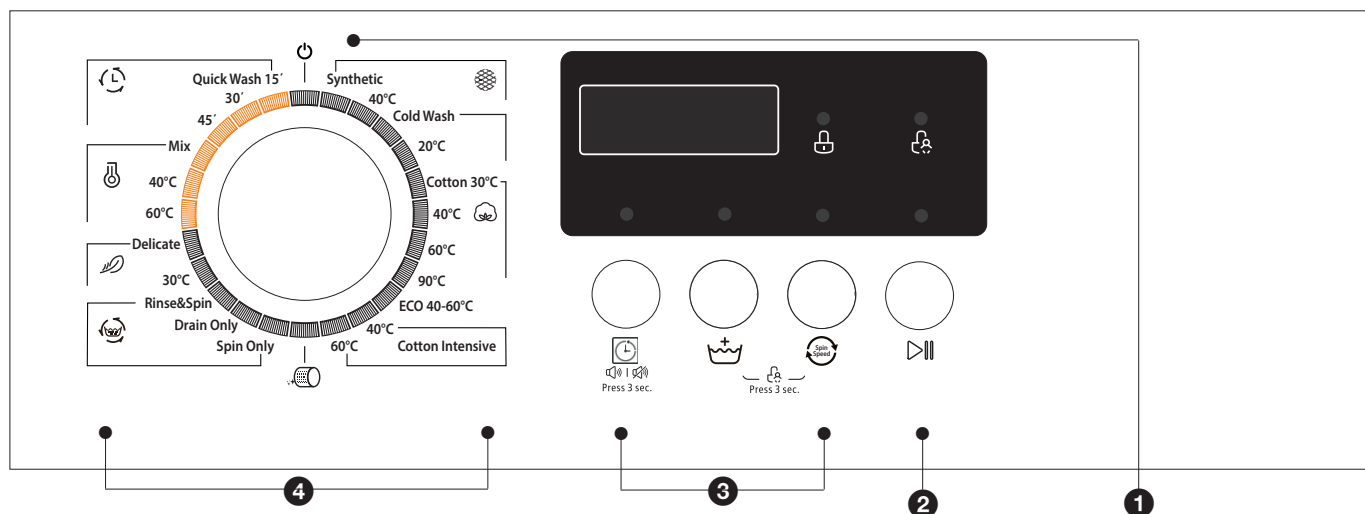

Note!

- The chart is for reference only, Please refer to real product as standard.

1 Off

Product is switched off.

3 Option

This allows you to select an additional function and will light when selected.

2 Start/Pause

Press the button to start or pause the washing cycle.

4 Programmes

Available according to the laundry type.

■ Option

Delay: Delay function can be set with this button, the delaying time is 0-24H.

Spin Speed: It can be set the spin speed to press the button repeatedly

Extra Rinse: The laundry will undergo extra rinse once after you select it.

Programme	Option	
	Delay	Extra Rinse
Cotton 30 °C	○	○
Cotton 40 °C	○	○
Cotton 60 °C	○	○
Cotton 90 °C	○	○
Synthetic	○	○
Synthetic 40 °C	○	○
Drum Clean	○	
Spin Only	○	
Cotton Intensive 40 °C	○	
Cotton Intensive 60 °C	○	
Quick Wash 45´	○	
Quick Wash 30´	○	

Programme	Option	
	Delay	Extra Rinse
Drain Only	○	
Rinse & Spin	○	○
Delicate 30 °C	○	○
Delicate	○	○
Mix 60 °C	○	○
Mix 40 °C	○	○
Mix	○	○
Cold Wash	○	○
Cold Wash 20 °C	○	○
ECO 40-60 °C	○	
Quick Wash 15´	○	

○ Means optional

■ Other functions

 |  **Mute the buzzer**



Choose the Programme

Press the [Prewash]/[Delay]button for 3sec. the buzzer is mute.

To act the buzzer function, press the button again for 3 seconds. The setting will be kept until the next reset.

⚠ Caution!

- After Muting the buzzer function, the sounds will not be activated any more.

Child Lock

To avoid mis operation by children.

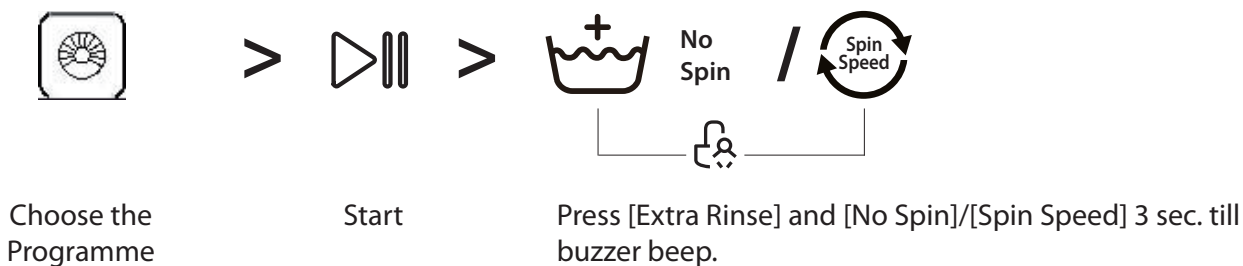

Caution!

- Press the two button 3sec. also to be released the function.
- The "Child Lock" will lock all buttons except [OFF].
- Cut off the power supply, the kid's protection is to be released.
- If you want to change the program on child lock condition, you should unlock the child lock first, then rotate the knob to OFF position, finally choose the program you want.

Temp.

The temperature is: Cold ,20 °C, 30 °C, 40 °C, 60 °C, 90 °C

Speed

The speed is:

800: 0-400-600-800; 1000: 0-400-600-800-1000;

1200: 0-400-600-800-1000-1200; 1300: 0-400-600-800-1000-1200-1300

Programme	Default Speed (rpm)
	1000
Cotton 30 °C	1000
Cotton 40 °C	800
Cotton 60 °C	800
Cotton 90 °C	800
Synthetic	1000
Synthetic 40 °C	1000
Drum Clean	-
Cold Wash	1000
Cold Wash 20 °C	1000
Cotton Intensive 40 °C	1000
Cotton Intensive 60 °C	1000
Eco 40-60	1000

Programme	Default Speed (rpm)
	1000
Spin Only	1000
Drain Only	-
Rinse & Spin	1000
Delicate 30 °C	600
Delicate	600
Quick Wash 45'	800
Quick Wash 30'	800
Quick Wash 15'	800
Mix 60 °C	1000
Mix 40 °C	1000
Mix	1000

■ Programmes

Programmes are available according to the laundry type.

Programmes	
Cotton/Normal	Hard-wearing textiles, heat-resistant textiles made of cotton or linen.
Synthetic	Wash synthetic articles, for example: shirts, coats, blending. While washing the knitting textiles, detergent quantity shall be reduced due to its loose string construction and easily forming bubbles.
DailyWash	It is suitable for washing few and not very dirty clothes quickly.
Cotton Eco	To increase the washing effects, washing time is increased.
Delicate	For delicate, washable textiles, e.g. made of silk, satin, synthetic fibres or blended fabrics.
Drum Clean	It applies 90 °C high temperature sterilization to make the clothes washing more green. When this procedure is performed, the clothes or other washing cannot be added. When proper amount of chlorine bleaching agent is put in, the barrel cleaning effect will be better. The customer can use this programme regularly according to the need.
Spin Only	Extra spin
Rinse & Spin	Extra rinse with spin.
Mix	You can select this procedure wash the tough clothes, that need much more time and strength. It is used for the daily clothes of cotton, such as sheets, chains, pillowcases bathrobe and underwear.
Quick Wash	It is suitable for washing few and not very dirty clothes quickly.
Cotton Intensive	To increase the washing effects, washing time is increased.
ECO 40-60	Default 40 °C, not selectable, suitable for laundry washing at about 40 °C - 60 °C.
Cold Wash	Cold water to wash clothes

■ Washing Programmes Table

Model: PLD 106 E

Programme	Load (kg)	Temp. (°C)	Default Time
	6.0	Default	6:0
Synthetic	3.0	Cold	2:20
Synthetic 40 °C	3.0	40	2:20
Cold Wash	6.0	Cold	1:00
Cold Wash 20 °C	6.0	20	1:01
Cotton 30 °C	6.0	30	2:40
Cotton 40 °C	6.0	40	2:40
Cotton 60 °C	6.0	60	2:45
Cotton 90 °C	6.0	90	2:50
ECO 40-60	6.0	60	3:16
Cotton Intensive 40 °C	6.0	40	4:04
Cotton Intensive 60 °C	6.0	60	4:08
Drum Clean	-	90	1:18
Spin Only	6.0	-	0:12
Drain Only	-	-	0:01
Rinse & Spin	6.0	-	0:20
Delicate 30 °C	2.5	30	0:50
Delicate	2.5	Cold	0:48
Mix 60 °C	6.0	60	1:11
Mix 40 °C	6.0	40	0:59
Mix	6.0	Cold	0:59
Quick Wash 45'	2.0	40	0:45
Quick Wash 30'	2.0	30	0:30
Quick Wash 15'	2.0	Cold	0:15

- The new EU energy efficiency class is E
Energy test program: ECO 40-60. Speed: the highest speed; Other as the default.
Half load for 6.0kg machines 3.3kg.
The old EU energy efficiency class is A
Energy test program: Cotton Intensive 60°C/40°C. Speed: the highest speed; Other as the default. Half load for 6.0kg machines 3.0kg.

Note!

- The parameters in this table are only for user's reference. The actual parameters may be different with the parameters in above mentioned table.

MAINTENANCES

■ Cleaning And Care

Warning!

- Before your maintenance starts, please unplug the machine and close the tap.

Cleaning The Cabinet

Proper maintenance on the washing machine can extend its working life. The surface can be cleaned with diluted non-abrasive neutral detergents when necessary. If there is any water overflow, use the wet cloth to wipe it off immediately. No sharp items are allowed.



Note!

- Formic acid and its diluted solvents or equivalent are forbidden, such as alcohol, solvents or chemical products, etc.

Cleaning The Drum

The rusts left inside the drum by the metal articles shall be removed immediately with chlorine-free detergents. Never use steel wool.

Note!

- Don't put laundry in the washing machine during the drum cleaning.

Cleaning The Door Seal And Glass

Wipe the glass and seal after each wash to remove lint and stains. If lint builds up it can cause leaks.

Remove any coins, buttons and other objects from the seal after each wash.

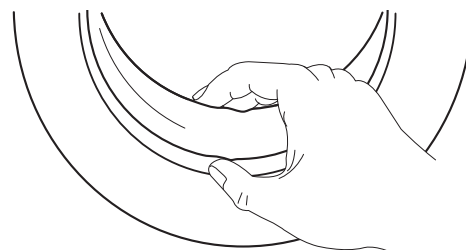

■ Cleaning The Inlet Filter

Note!

- Inlet filter must be cleaned if there is less water.

Washing the filter in the tap

1. Close the tap.
2. Remove the water supply hose from the tap.
3. Clean the filter.
4. Reconnect the water supply hose.

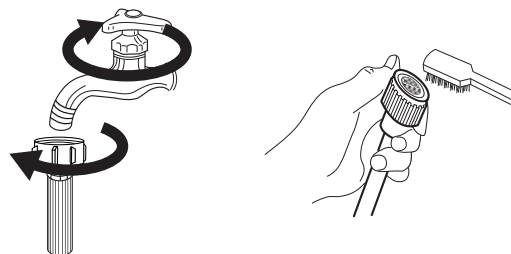

Washing the filter in washing machine:

1. Screw off the inlet pipe from the backside of the machine.
2. Pull out the filter with long nose pliers and reinstall it back after being washed.
3. Use the brush to clean the filter.
4. Reconnect the inlet pipe.

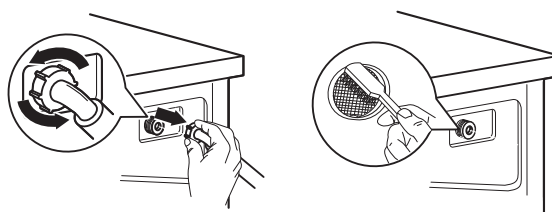

Note!

- If the brush is not clean, you can pull out the filter washed separately;
- Reconnect, turn on the tap.

Clean The Detergent Dispenser

1. Press down the arrow location on softener cover inside the dispenser drawer.
2. Lift the clip up and take out softener cover and wash all grooves with water.
3. Restore the softener cover and push the drawer into position.

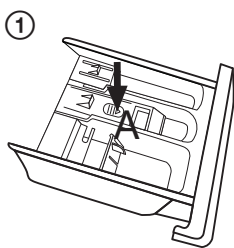

Pull out the dispenser drawer with press the A

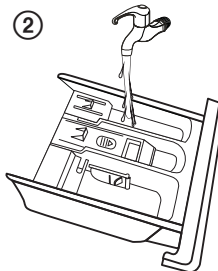

Clean the dispenser drawer under water

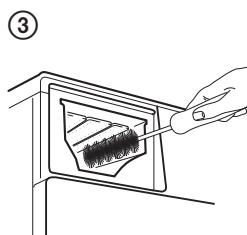

Clean inside the recess with an old toothbrush

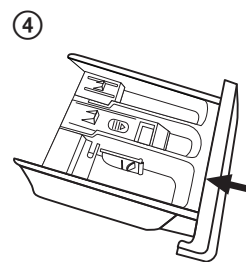

Insert the dispenser drawer

Note!

- Do not use alcohol, solvents or chemical products to clean the machine.

■ Cleaning The Drain Pump Filter

Warning!

- Be careful of the hot water!
- Allow detergent solution to cool down.
- Unplug the machine to avoid electrical shock before washing.
- Drain pump filter can filter the yarns and small foreign matters from the washing.
- Clean the filter periodically to ensure the normal operation of washing machine.

①

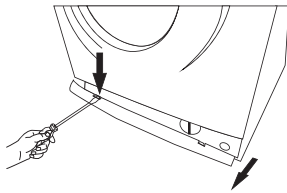

Open the Service filter

②

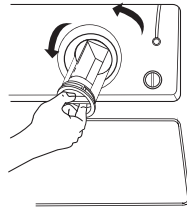

Open the filter
by turning to the
counter clockwise

③

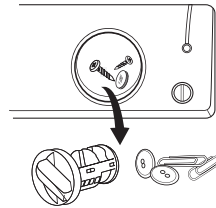

Remove extraneous
matter

④

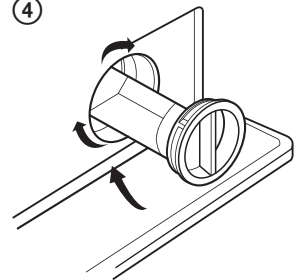

Close the lower cover
cap

Caution!

- Make sure that valve cap and emergency drain hose are reinstalled properly, cap plates should be inserted aligning to hole plates otherwise water may leak;
- Some machines don't have emergency drain hose, rotate lower cover cap directly to make water run into basin.
- When the appliance is in use and depending on the programme selected there can be hot water in the pump. Never remove the pump cover during a wash cycle, always wait until the appliance has finished the cycle, and is empty. When replacing the cover, ensure it is securely re-tightened.

■ Trouble Shooting

The start of the appliance does not work or it stops during operation.
First try to find a solution to the problem. If not, contact the service centre.

Description	Reason	Solution
Washing machine cannot startup.	Door is not closed properly.	Restart after the door is closed. Check if the clothes is stuck.
Door can't be opened.	Washer's safety protection design is working.	Disconnect the power, restart the product.
Water leakage	The connection between inlet pipe or outlet hose is not tight.	Check and fasten water pipes. Clean up outlet hose.
Detergent residues in the box.	Detergent is dampened or agglomerated.	Clean and wipe the detergent box.
Indicator or display does not light.	Disconnect the power. PC board or harness has connection problem.	Check if the power is shut down and the power plug is connected correctly.
Abnormal noise		Check if the fixing (bolts) have been removed. Check it's installed on a solid and level floor.

Description	Reason	Solution
E30	Door is not closed properly.	Restart after the door is closed. Check if the clothes is stuck.
E10	Water injecting problem while washing.	Check if the water pressure is too low. Straighten the water pipe. Check if the inlet valve filter is blocked.
E21	Overtime water draining.	Check if the drain hose is blocked.
E12	Water overflow.	Restart the washer.
Others	Please try again first, call up service line if there are still troubles.	

Note!

- After the check, activate the appliance. If the problem occurs again, contact the service.

■ Technical Specifications

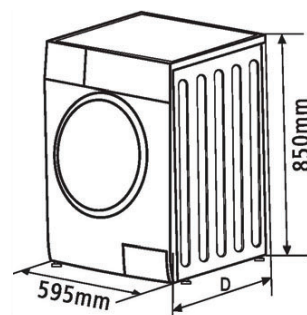

Power Supply	220 - 240 V ~, 50Hz			
MAX. Current	10 A			
Standard Water Pressure	0.05 MPa - 1MPa			
Model	Washing Capacity	Dimension (W/D/H) mm	Net Weight	rated Power
PLD 106 E	6.0kg	595/400/850	52kg	2000W

PRODUCT INFORMATION SHEET

Product Information Sheet

PHILCO 

COMMISSION DELEGATED REGULATION (EU) 2019/2016

Supplier's name or trademark: PHILCO

Supplier's address: U Sanitasu 1621 Říčany 251 01, Czech Republic

Model identifier: PLD 106 E

General product parameters: Washmachine

Parameter	Value		Parameter	Value	
Rated capacity (kg)	6.0		Dimensions in cm	Height	85
				Width	60
				Depth	40
EEI _w	91.0		Energy efficiency class*	E	
Washing efficiency index	1.031		Rinsing effectiveness (g/kg)	5.0	
Energy consumption in kWh per cycle, based on the eco 40-60 programme. Actual energy consumption will depend on how the appliance is used.	0.737		Water consumption in litre per cycle, based on the eco 40-60 programme. Actual water consumption will depend on how the appliance is used and on the hardness of the water.	43	
Maximum temperature inside the treated textile (°C)	Rated capacity	41	Remaining moisture content (%)	Rated capacity	62.9
	Half	33		Half	62.9
	Quarter	20		Quarter	62.9
Spin speed (rpm)	Rated capacity	1000	Spin-drying efficiency class	C	
	Half	1000			
	Quarter	1000			
Programme duration (h:min)	Rated capacity	3:18	Type	Free-standing	
	Half	2:36			
	Quarter	2:36			
Airborne acoustical noise emissions in the spinning phase (dB(A) re 1 pW)	80		Airborne acoustical noise emission class (spinning phase)	C	

Off-mode (W)	0.50	Standby mode (W)	1.00
Delay start (W) (if applicable)	4.00	Networked standby (W) (if applicable)	N/A
Minimum duration of the guarantee offered by the supplier: 24 months			
This product has been designed to release silver ions during the washing cycle		No	
Additional information:			
Weblink to the supplier's website, where the information in point 9 of Annex II to Commission Regulation (EU) 2019/2023 is found: www.philco.cz			

* A (highest efficiency) to G (lowest efficiency)

 **Note!**

- Programme setting for testing in accordance with applicable standard En60456.
- When using the test programmes, wash the specified load using the maximum spin speed.
- The actual parameters will depend on how the appliance is used, and maybe different with the parameters in above mentioned table.

Remarks:

- 1 The energy efficiency class is from A (highest efficiency) to D (lowest efficiency).
- 2 Energy consumption per year, based on 220 standard washing cycles for standard programme at 60 °C and 40 °C at full and partial load, and the consumption of the low-power modes. Actual energy consumption will depend on how the appliance is used.
- 3 Water consumption per year based on 220 standard washing cycles for standard programme at 60 °C and 40 °C at full and partial load. Actual water consumption will depend on how the appliance is used.
- 4 Spin-drying efficiency class from G (least efficient) to A (most efficient).
- 5 The standard 60 °C programme and the standard 40 °C programme are the standard washing programmes. These programmes are suitable to clean normally soiled cotton laundry and they are the most efficient programmes in terms of combined energy and water consumptions for washing that type of cotton laundry. The actual water temperature may differ from the declared cycle temperature. Please choose the suitable type of detergent for the various washing temperatures to get the best washing performance with less water and energy consumption.

TECHNICAL INFORMATION

Technical information can be found on the type plate on the inside of the appliance and on the energy label. The QR code, on the supplied energy label, contains a link to register the appliance in the EU Eprel database. Keep the energy label, the instructions for use, together with other documents supplied with the device.

TESTING INFORMATION

The delivered device is in accordance with EcoDesign and EN62552. Air access requirements for proper operation of the device, the minimum distance from the wall and the dimensions of the device are part of this manual. If you have any further questions, please contact the manufacturer.

CUSTOMER CARE AND SERVICE

Always use original spare parts.

Model name and serial number can be found on the rating plate. Position of rating plate can be changed without notice.

The original spare parts for some specific components are available for a minimum of 7 or 10 years, based on the type of component, from the placing on the market of the last unit of the model.

When contacting our authorized service, have the model designation, serial number and defect description available.

To download documents, visit www.philco.cz.

To report a defect and obtain additional service information, visit <https://philco.cz/podpora-a-servis>.

Subject to change without notice.

INSTRUCTIONS AND INFORMATION REGARDING THE DISPOSAL OF USED PACKAGING MATERIALS

Dispose of packaging material at a public waste disposal site.

DISPOSAL OF USED ELECTRICAL AND ELECTRONIC APPLIANCES



The meaning of the symbol on the product, its accessory or packaging indicates that this product shall not be treated as household waste. Please, dispose of this product at your applicable collection point for the recycling of electrical & electronic equipment waste. Alternatively in some states of the European Union or other European states you may return your products to your local retailer when buying an equivalent new product. The correct disposal of this product will help save valuable natural resources and help in preventing the potential negative impact on the environment and human health, which could be caused as a result of improper liquidation of waste. Please ask your local authorities or the nearest waste collection centre for further details. The improper disposal of this type of waste may fall subject to national regulations for fines.

For business entities in the European Union

If you wish to dispose of an electrical or electronic device, request the necessary information from your seller or supplier.

Disposal in other countries outside the European Union

If you wish to dispose of this product, request the necessary information about the correct disposal method from local government departments or from your seller.



This product meets all the basic EU regulation requirements that relate to it.

Changes to the text, design and technical specifications may occur without prior notice and we reserve the right to make these changes.

Original of this user manual is in czech language.

Výrobce/Manufacturer:
Fast ČR, a.s.
U Sanitasu 1621
Říčany 251 01, CZECH REPUBLIC

Distributor:
FAST PLUS, a.s.
Na pántoch 18
831 06 Bratislava, SLOVAKIA

Distributor:
FAST POLAND Sp. z o. o.
Kwietniowa 36
05-090 Wypędy, POLAND

Distributor:
FAST HUNGARY Kft.
H-2310 Szigetszentmiklós
Kántor utca 10, HUNGARY

PHILCO 

is a pending or registered trademark of Electrolux Home Products, Inc. and used under a license from Electrolux Home Products, Inc.