



Welcome to
Animal Crossing

77049



WARNING: CHOKING HAZARD. Toy contains small parts and a small ball. Not for children under 3 years.



LEGO® Builder



Get excited about our new packaging!

We're switching from plastic to paper-based packaging. That's why you might find a mix of paper and plastic in our boxes!

Nos nouveaux emballages vous emballeront !

Nous passons des emballages en plastique aux emballages à base de papier. C'est pourquoi vous pourriez trouver un mélange de papier et de plastique dans nos boîtes !

¡Te presentamos nuestros nuevos empaques!

Estamos sustituyendo las bolsas de plástico por bolsas con base de papel. ¡Por eso, puedes encontrar una mezcla de papel y de plástico en nuestras cajas!

[LEGO.com/sustainable-packaging](https://www.lego.com/sustainable-packaging)

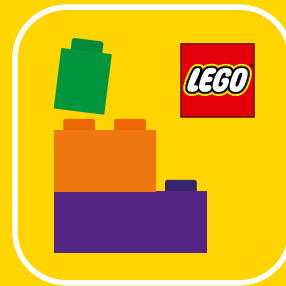

🔍 LEGO® Builder

BUILDER

Download on the
App Store

GET IT ON
Google Play

腾讯应用宝
安卓应用商店

Apple and the Apple logo are trademarks of Apple Inc., registered in the U.S. and other countries and regions. App Store is a service mark of Apple Inc. Google Play and the Google Play logo are trademarks of Google LLC. Tencent and the Tencent logo are trademarks of Tencent Inc.

🔍 LEGO.com/devicecheck

EN Ask parents' permission before going online | **DE** Eltern um Erlaubnis bitten, bevor du online gehst | **FR** Demande l'autorisation d'un parent avant d'aller en ligne | **IT** Chiedi il permesso ai tuoi genitori prima di andare online | **ES** Pídeles permiso a tus papás antes de conectarte a Internet | **PT** Pede autorização aos pais antes de acederes online | **ZH** 上网前应先征得父母的同意 | **PL** Poproś rodziców o zgodę, zanim wejdiesz do Internetu | **CS** Než půjdeš na internet, požádej rodiče o svolení | **SK** Skôr než pôjdeš na internet, vypýtaj si povolenie od rodičov | **HU** Kérj szülői engedélyt, mielőtt online csatlakoznál! | **RO** Cere permisiunea părinților înainte de a te conecta online | **BG** Поискайте разрешение от родител, преди да влезете онлайн | **LV** Pirms došanās tiešsaistē palūdz atļauju vecākiem | **ET** Enne Interneti kasutamist küsi vanematelt luba | **LT** Prieš prisijungdami prie interneto, atsilkauskite tėvų



AVERTISSEMENT : RISQUE D'ÉTOUFFEMENT.

Le jouet contient des petites pièces ainsi qu'une petite boule.
Il ne convient pas aux enfants de moins de 3 ans.



ADVERTENCIA: PELIGRO DE ASFIXIA.

Juguete que contiene partes pequeñas y una pelota pequeña.
No recomendado para niños menores de 3 años.



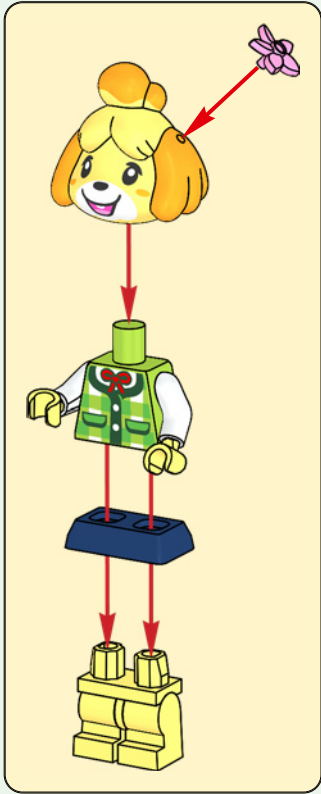

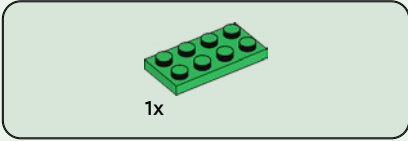
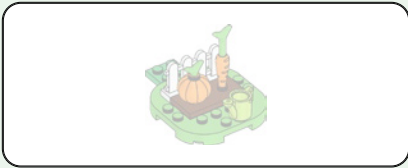

1

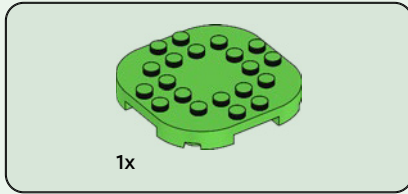
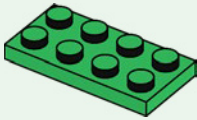

2

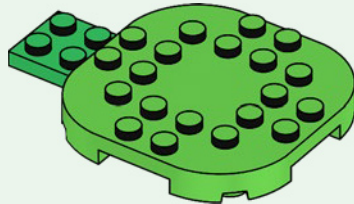

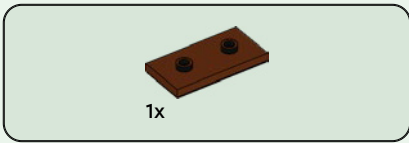

3

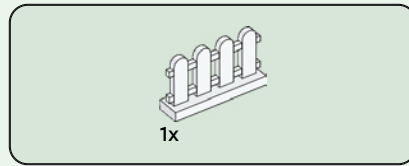
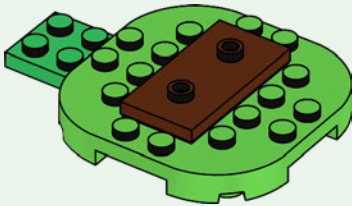

4

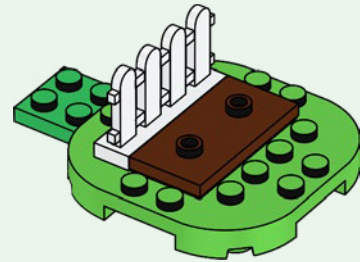

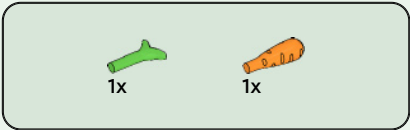

5

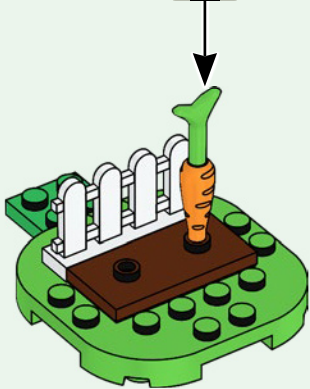
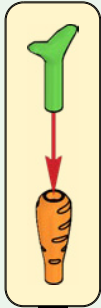

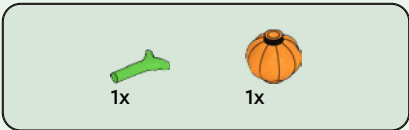

6

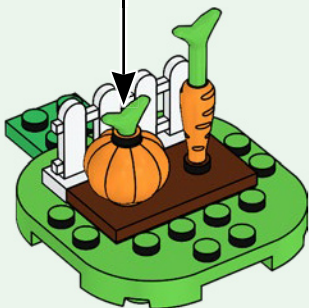
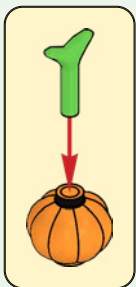

7



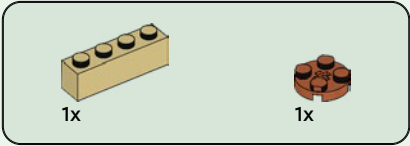
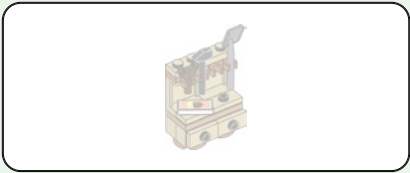

1

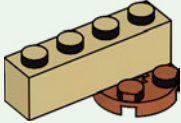



1x

2

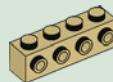
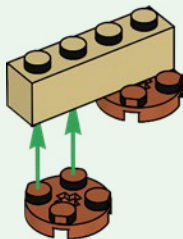

1x

3

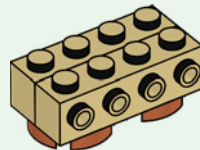

1x

4





4x

5

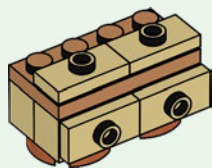

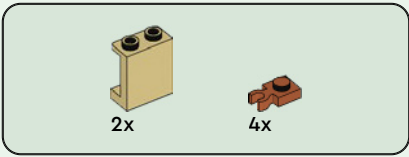

6

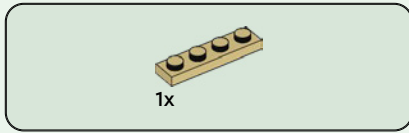
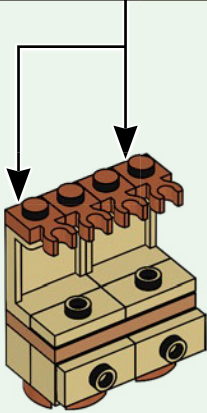
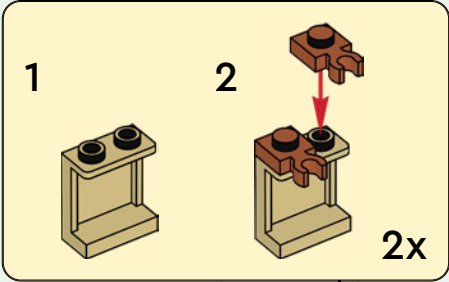

7

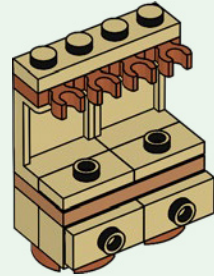

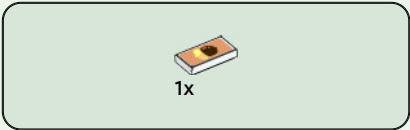

8

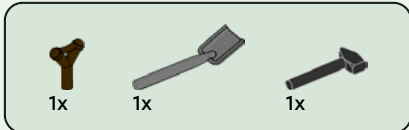
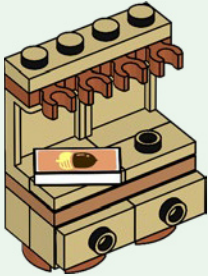

9

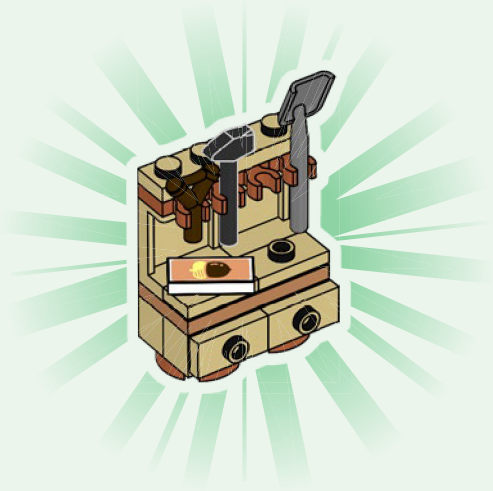

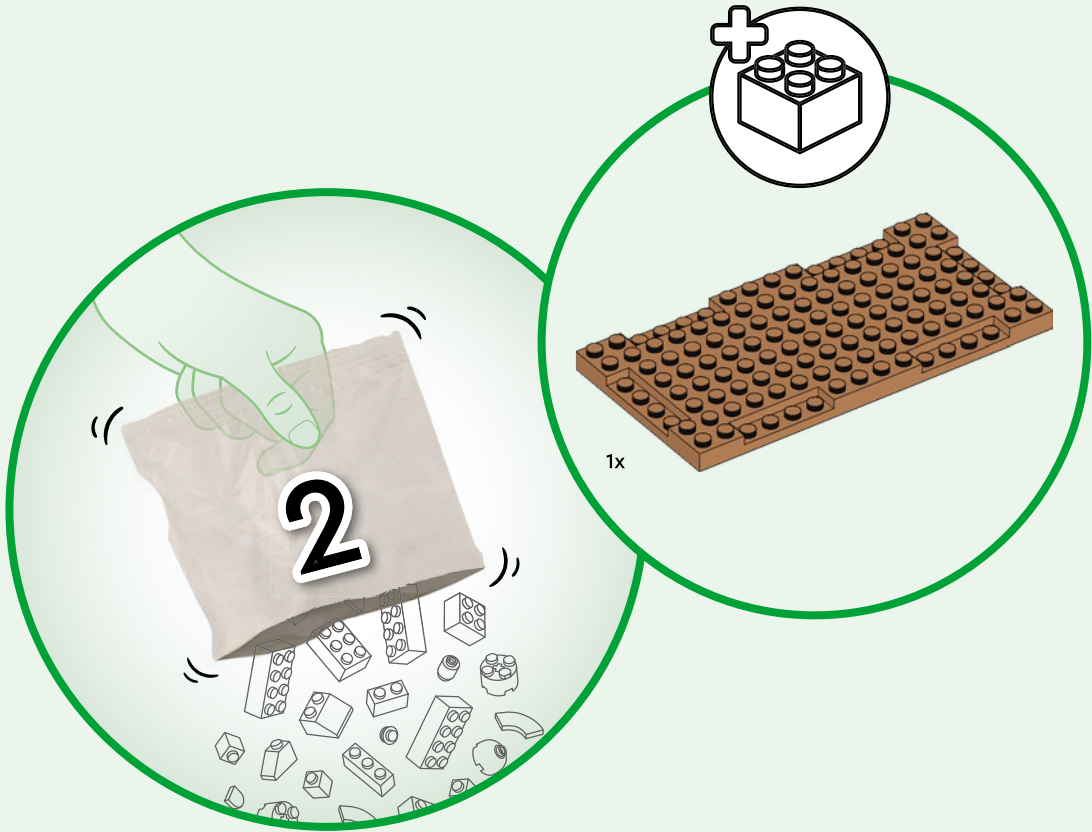

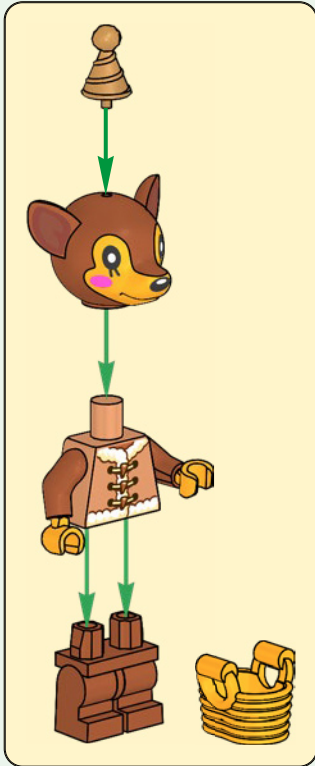

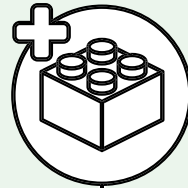
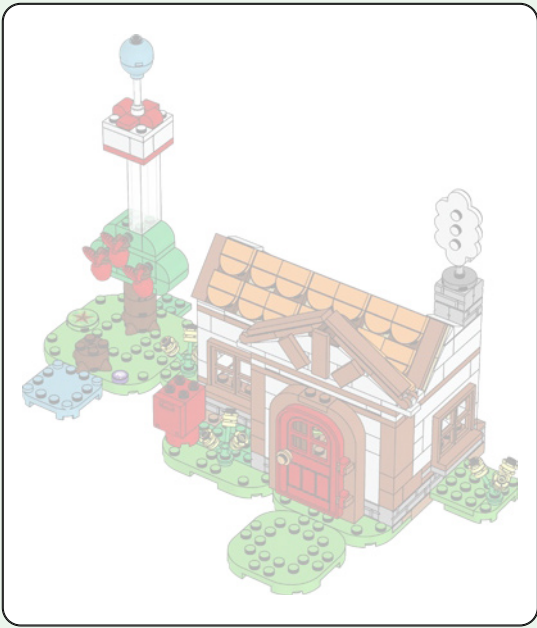

1

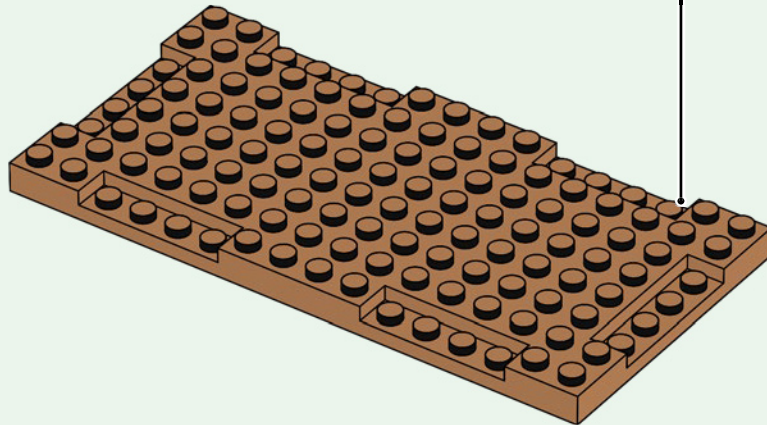

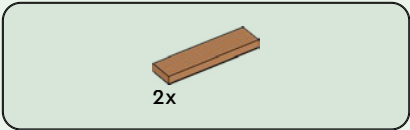

2

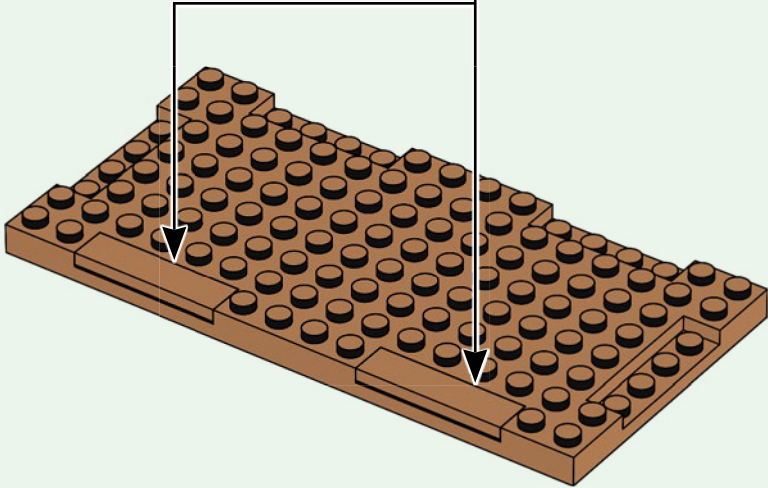
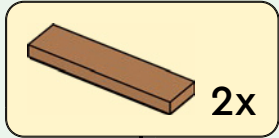

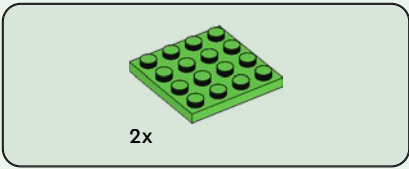

3

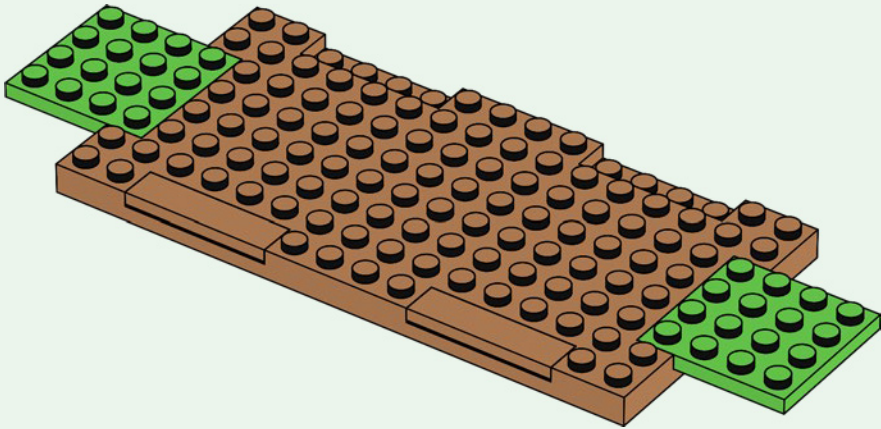

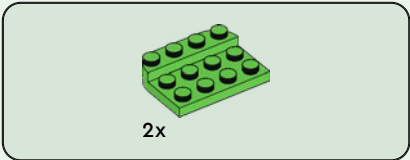

4

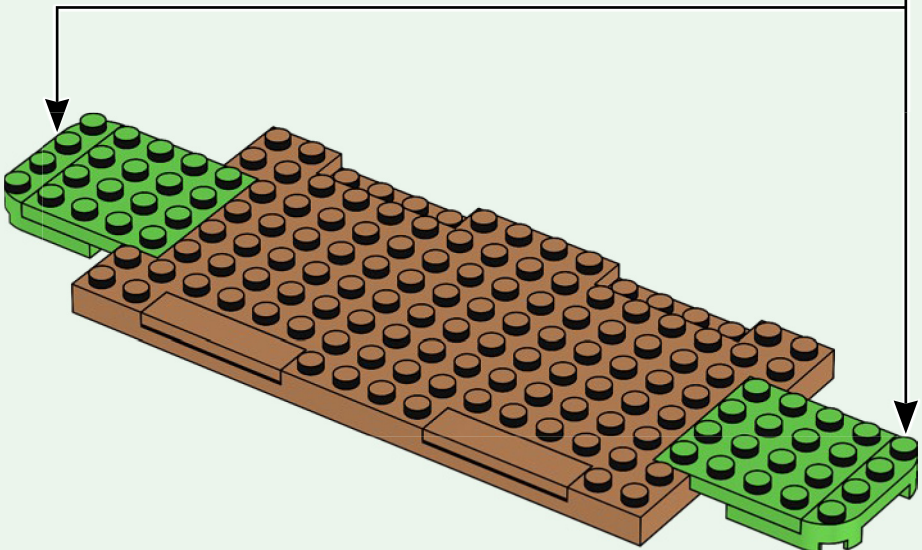
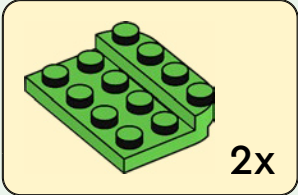

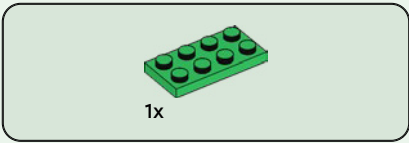

5

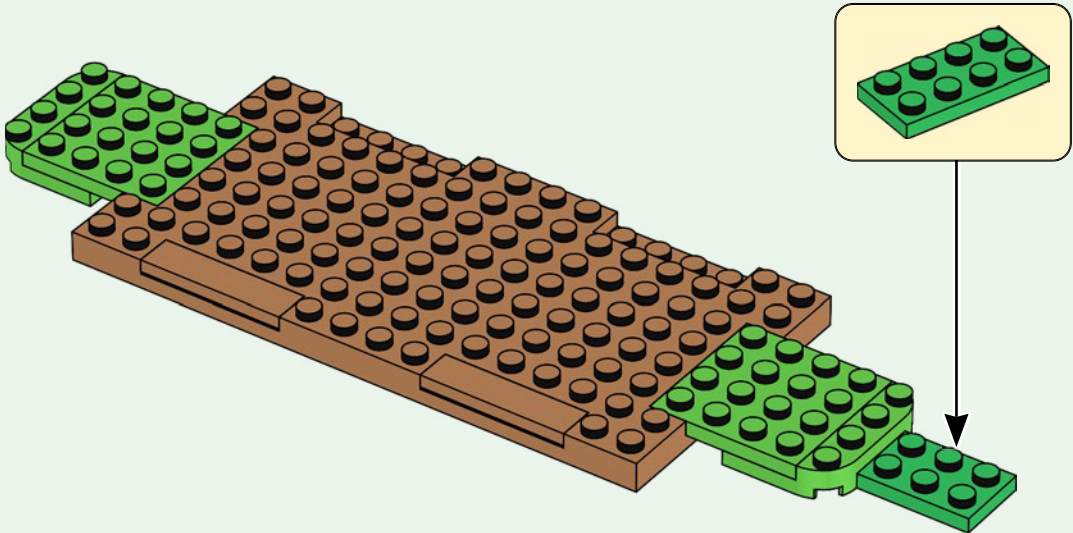

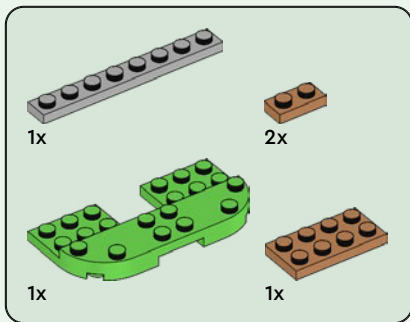

6

1

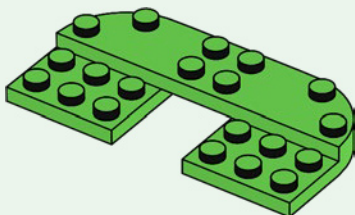

2

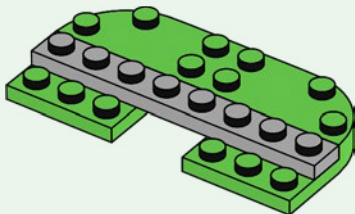

3

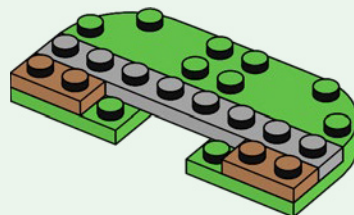

4

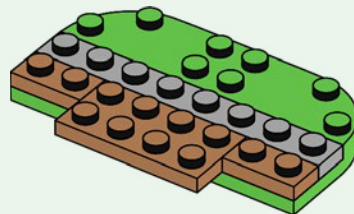

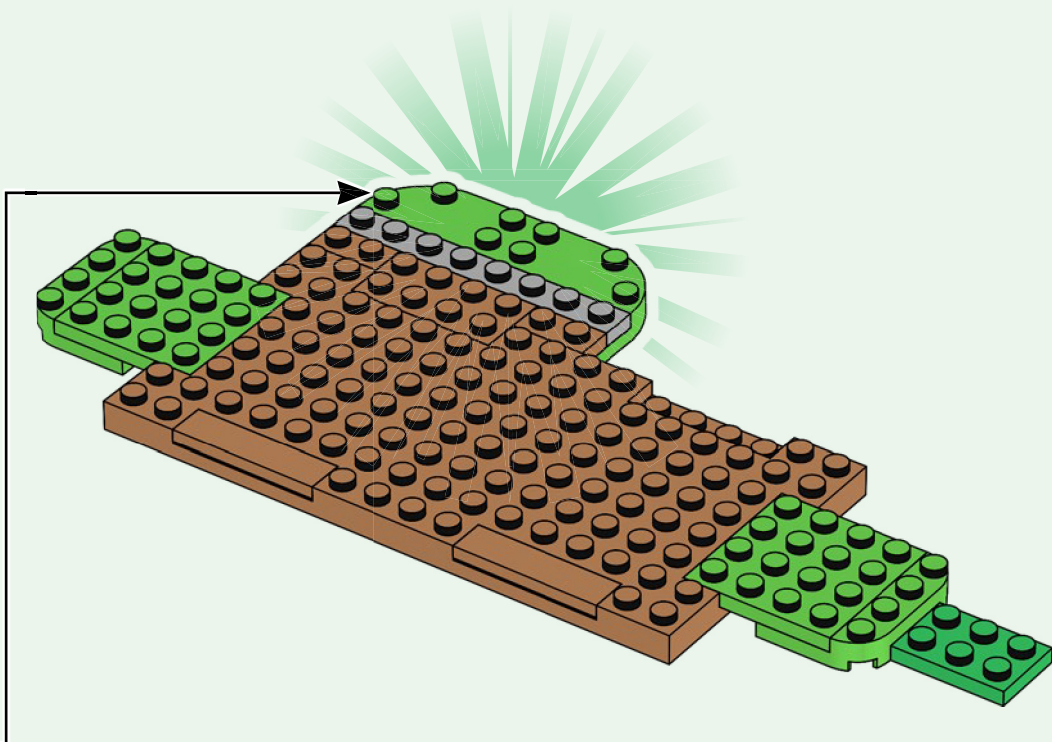

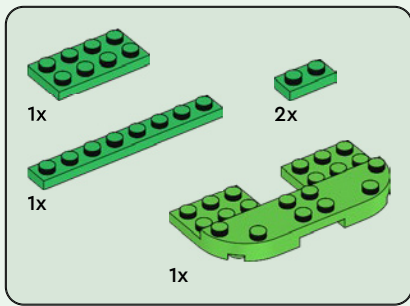

7

1

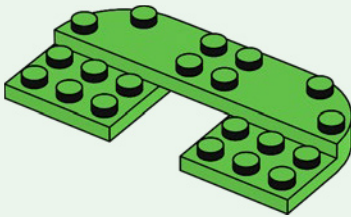

2

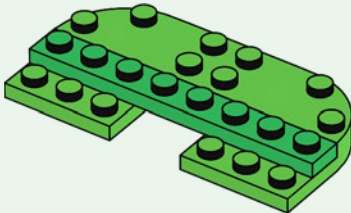

3

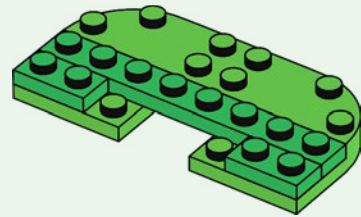

4

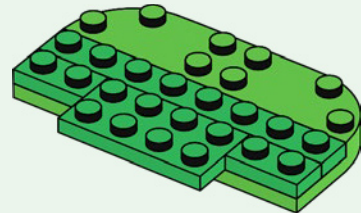

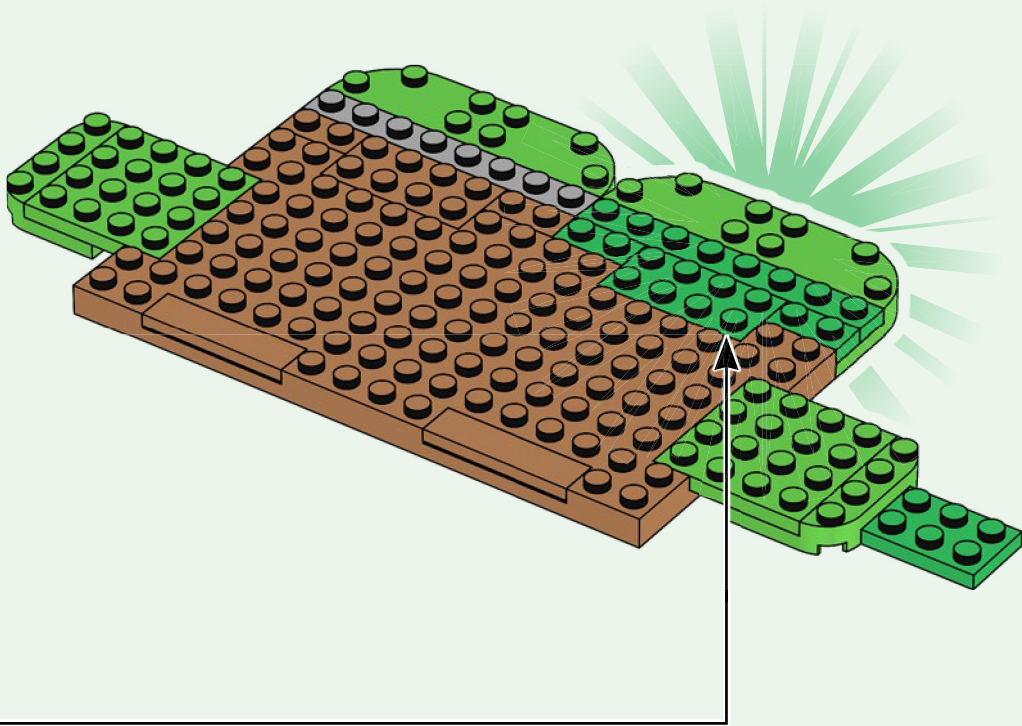

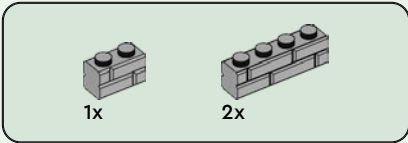

8

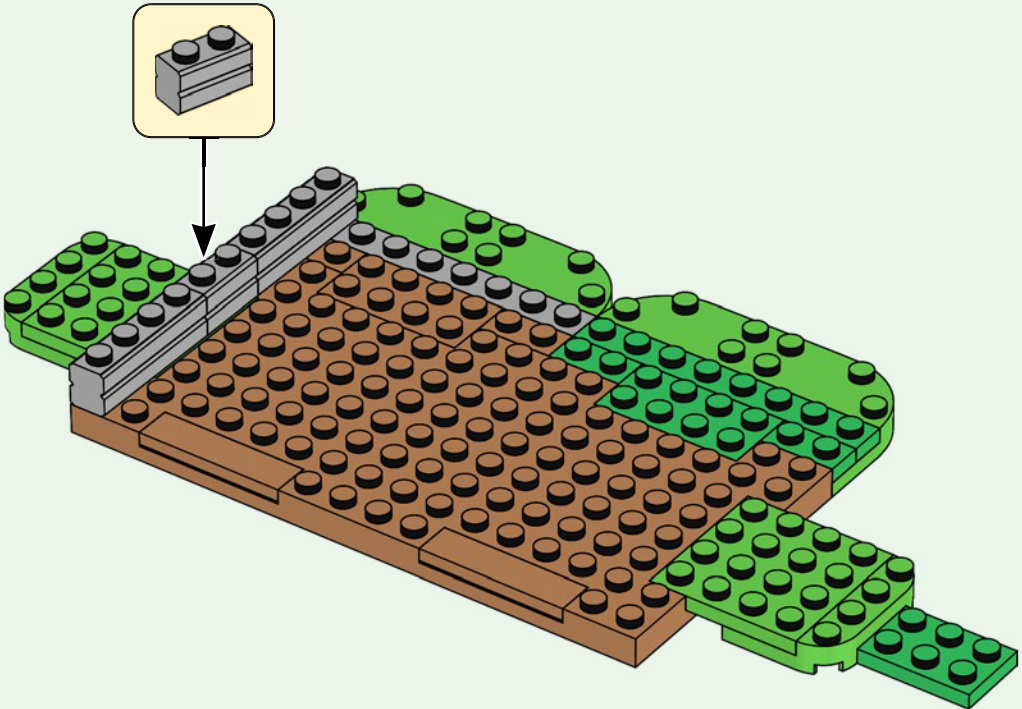



1x

9

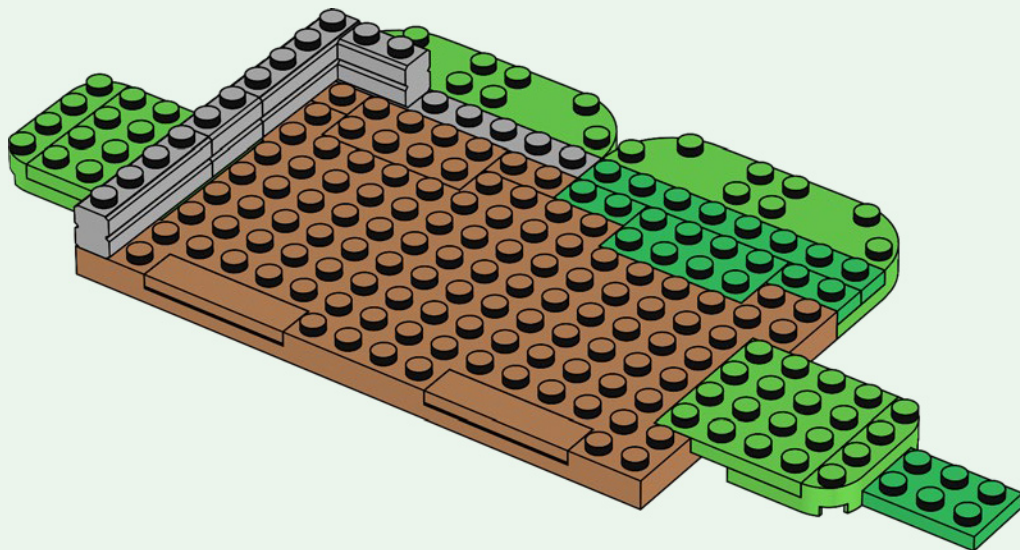

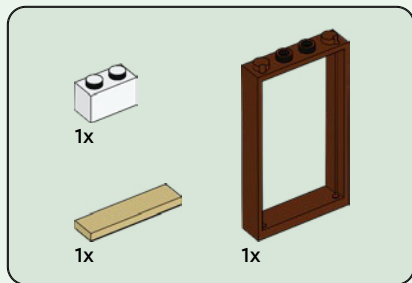

10

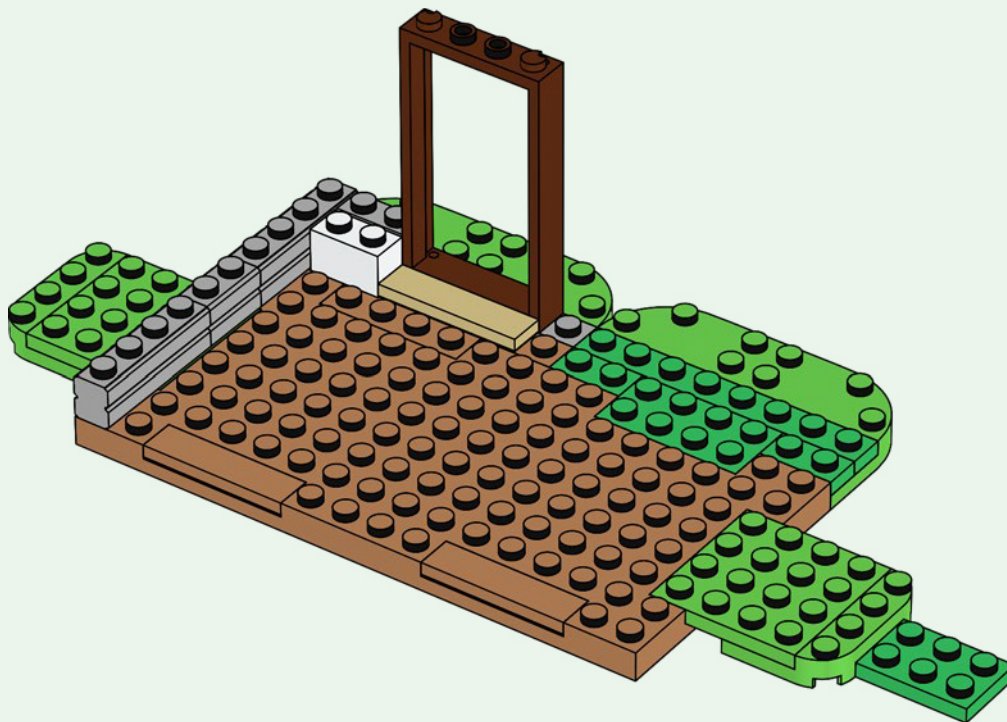



1x



1x

11

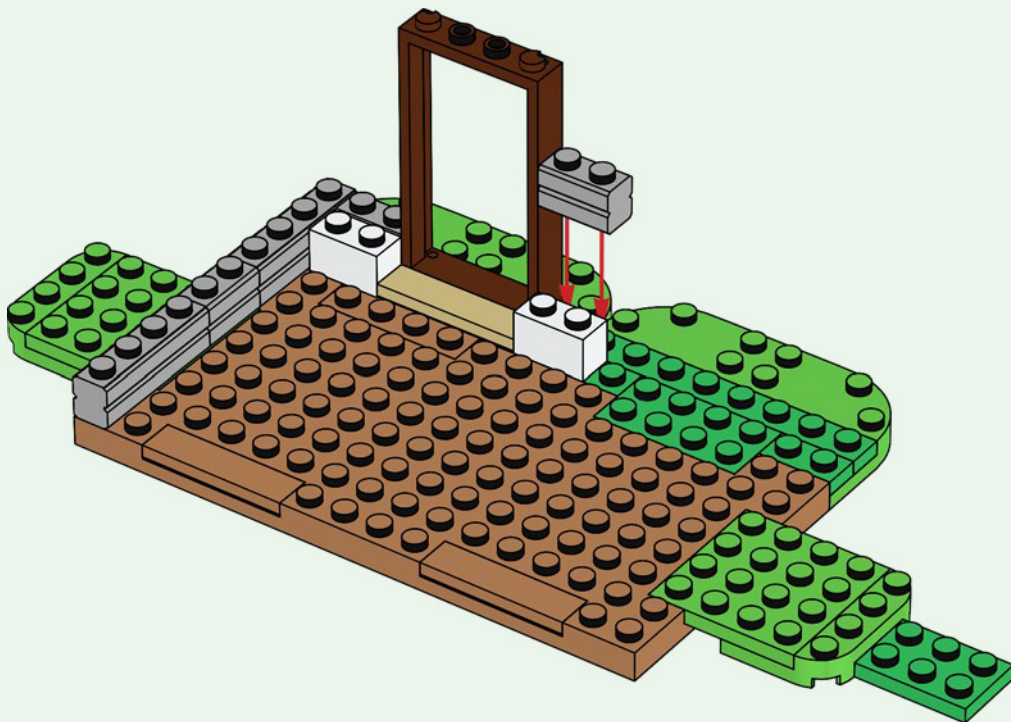

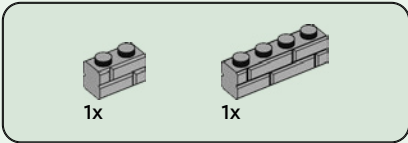

12

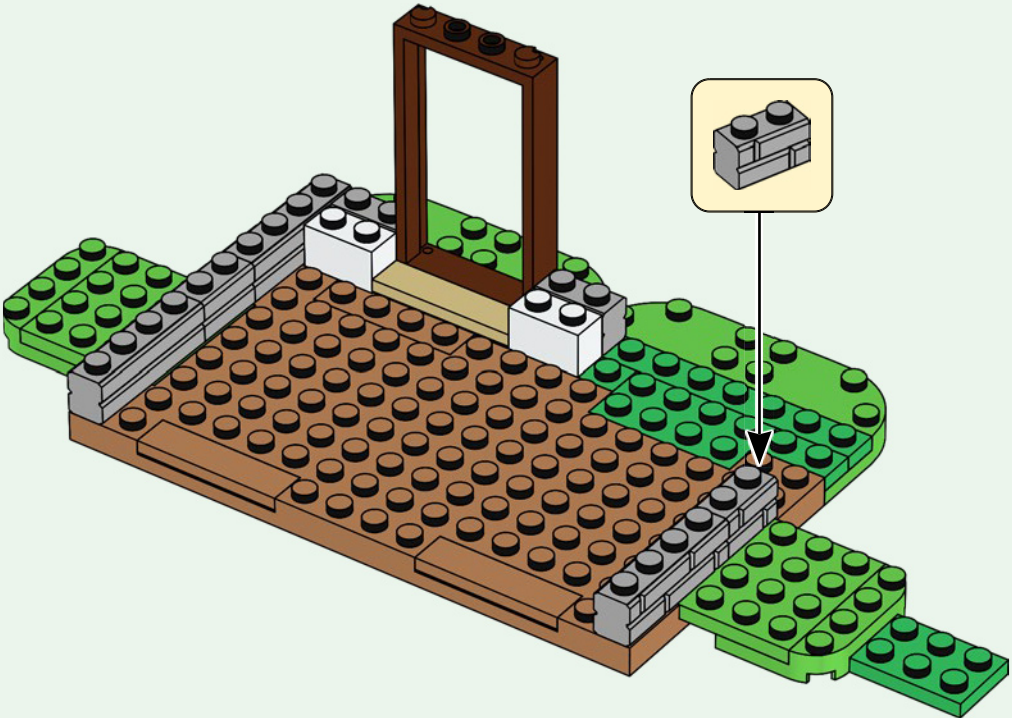



1x

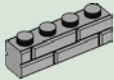

2x

13

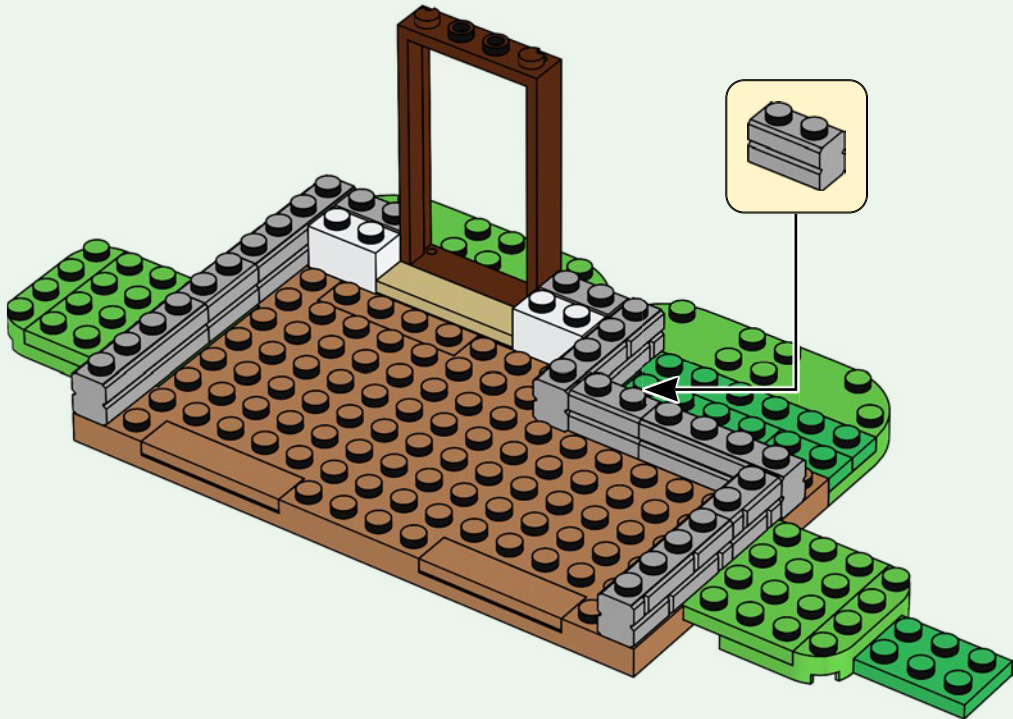



1x



1x

14

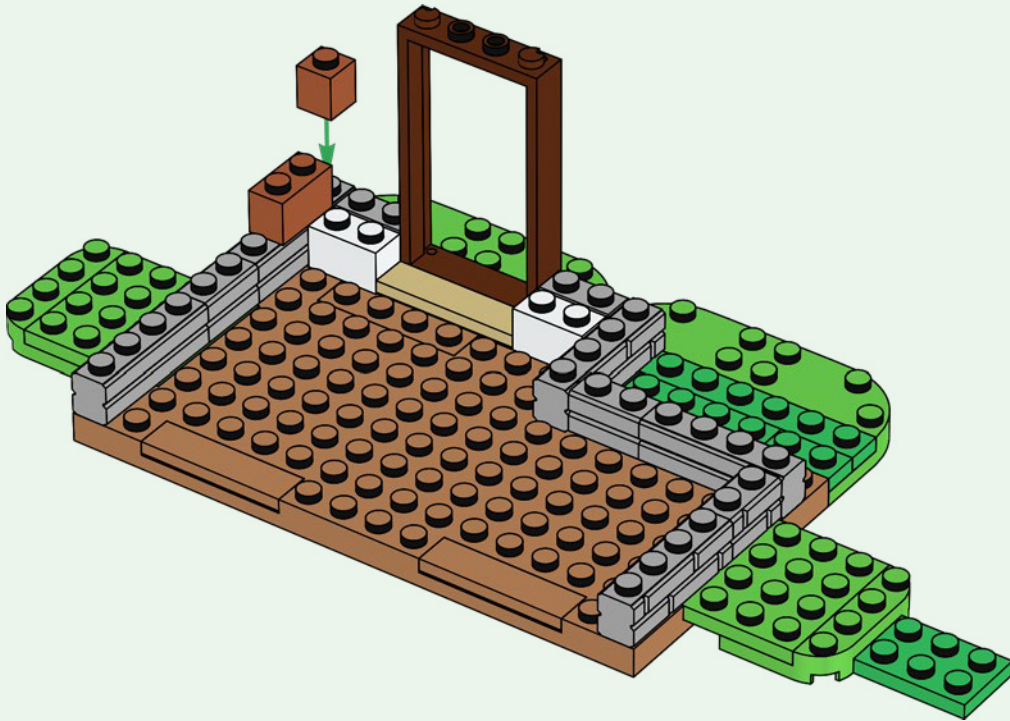



1x



2x

15

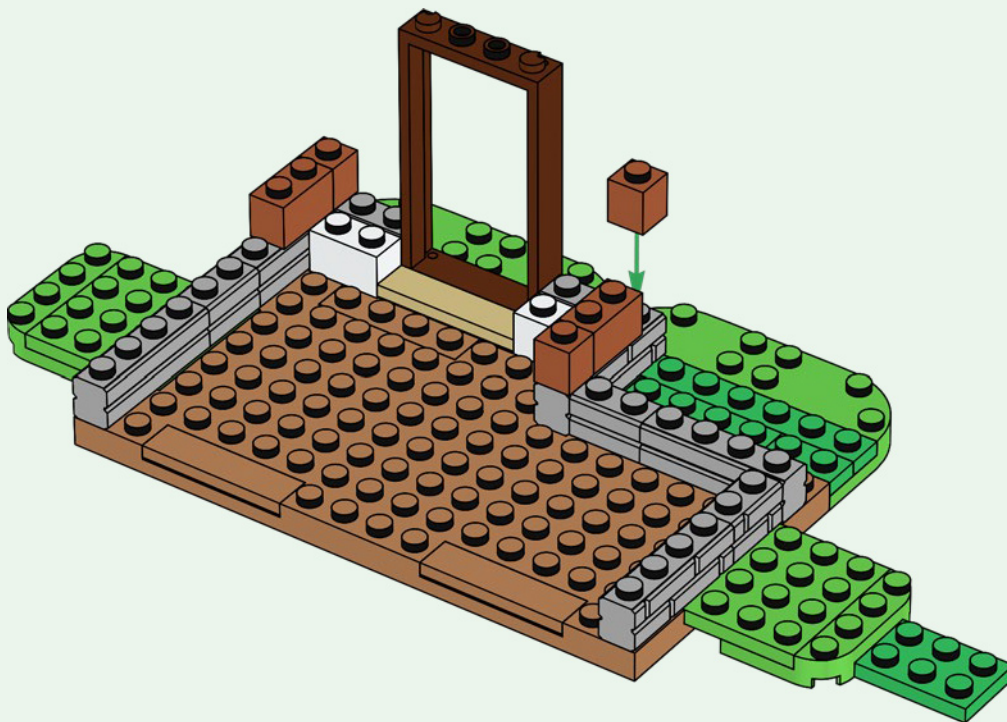

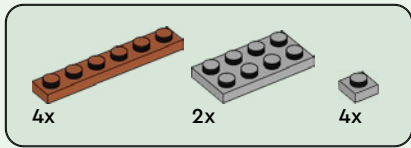

16

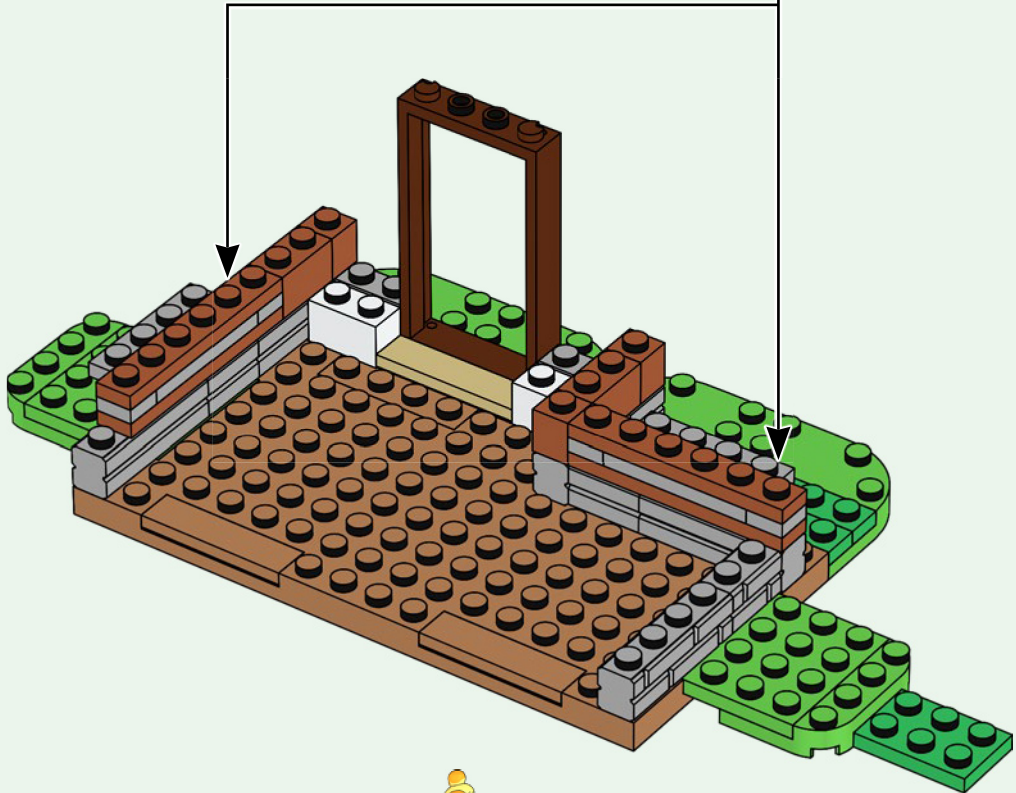
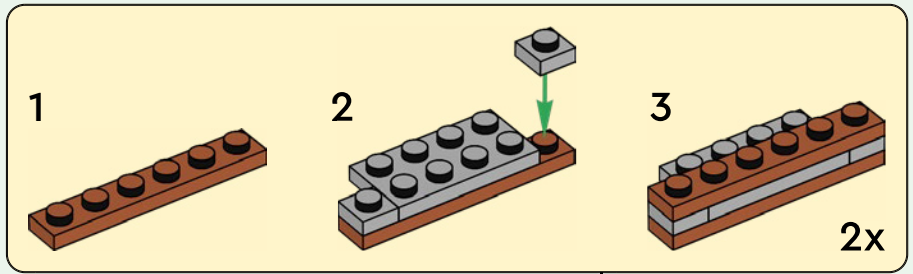



2x



1x

17

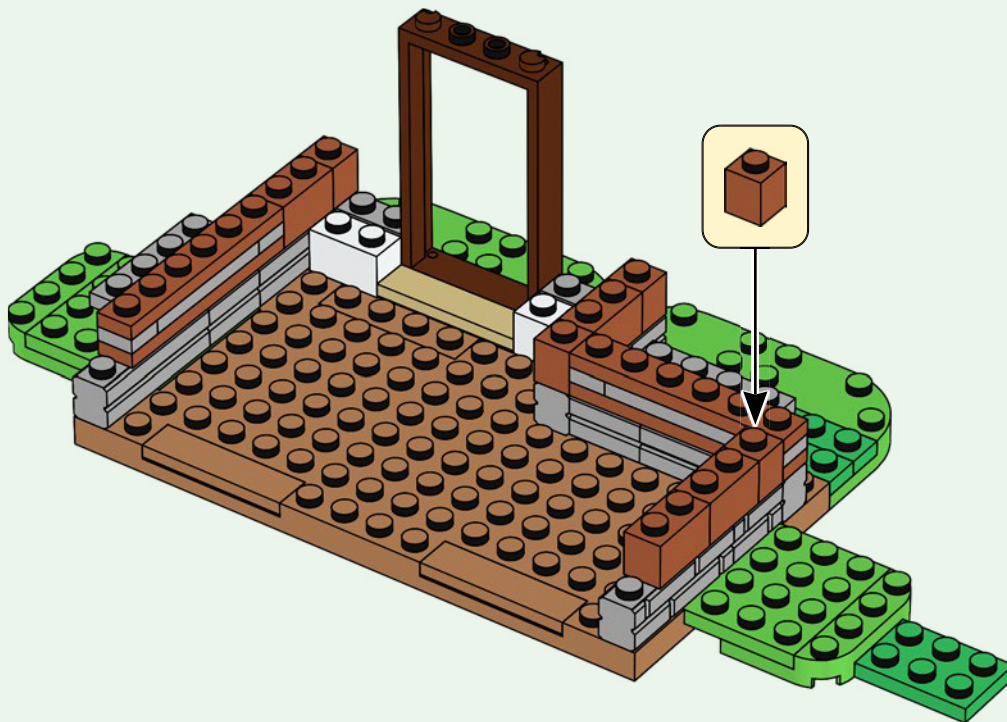



2x

18

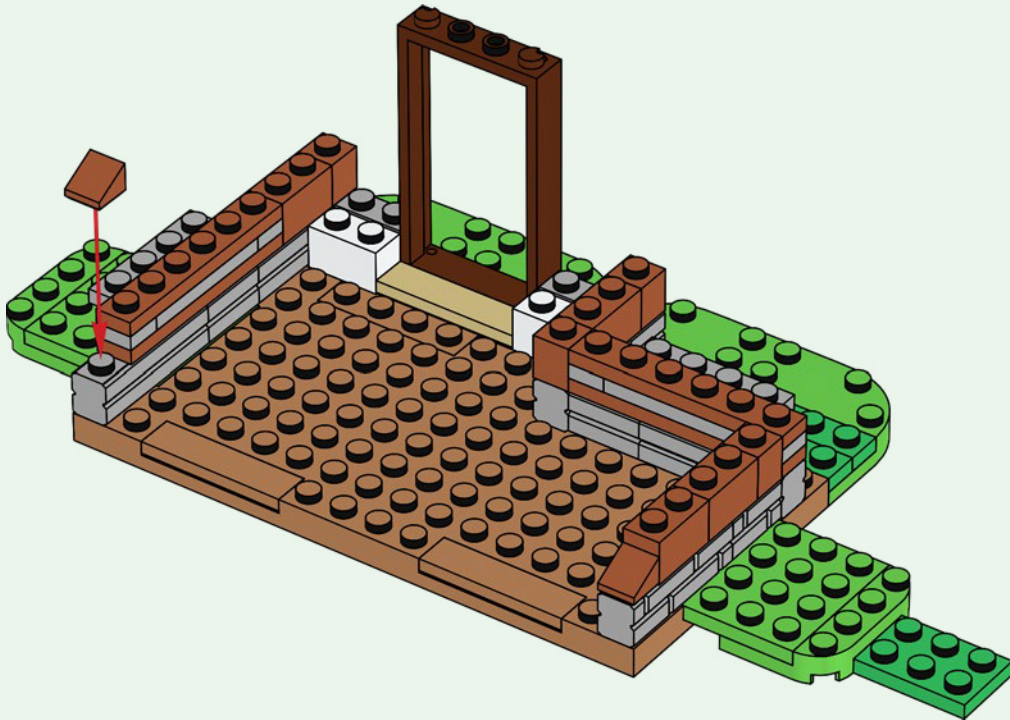

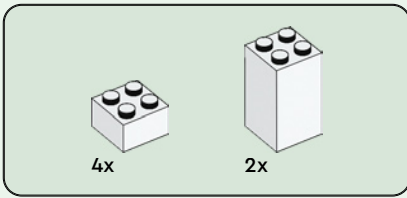

19

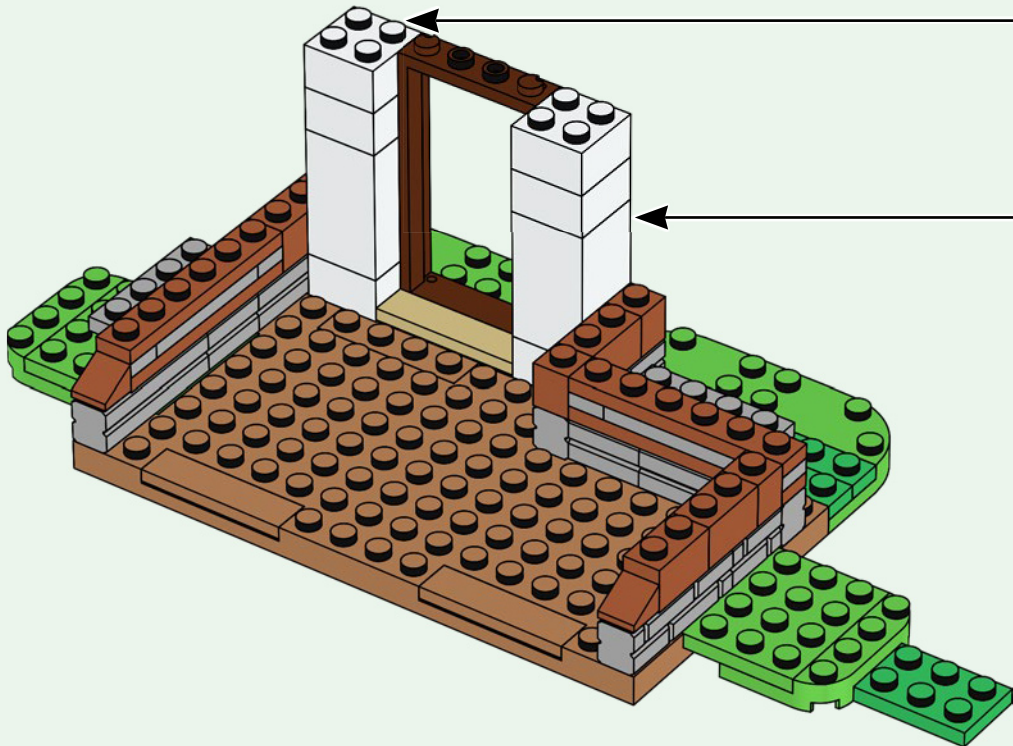
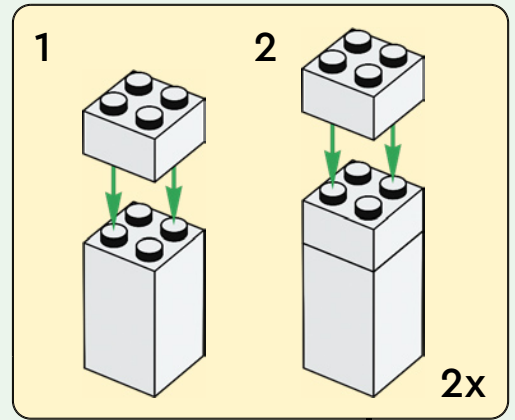

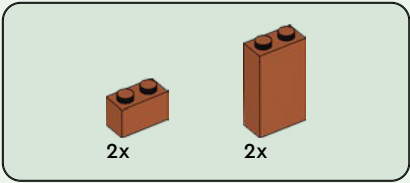

20

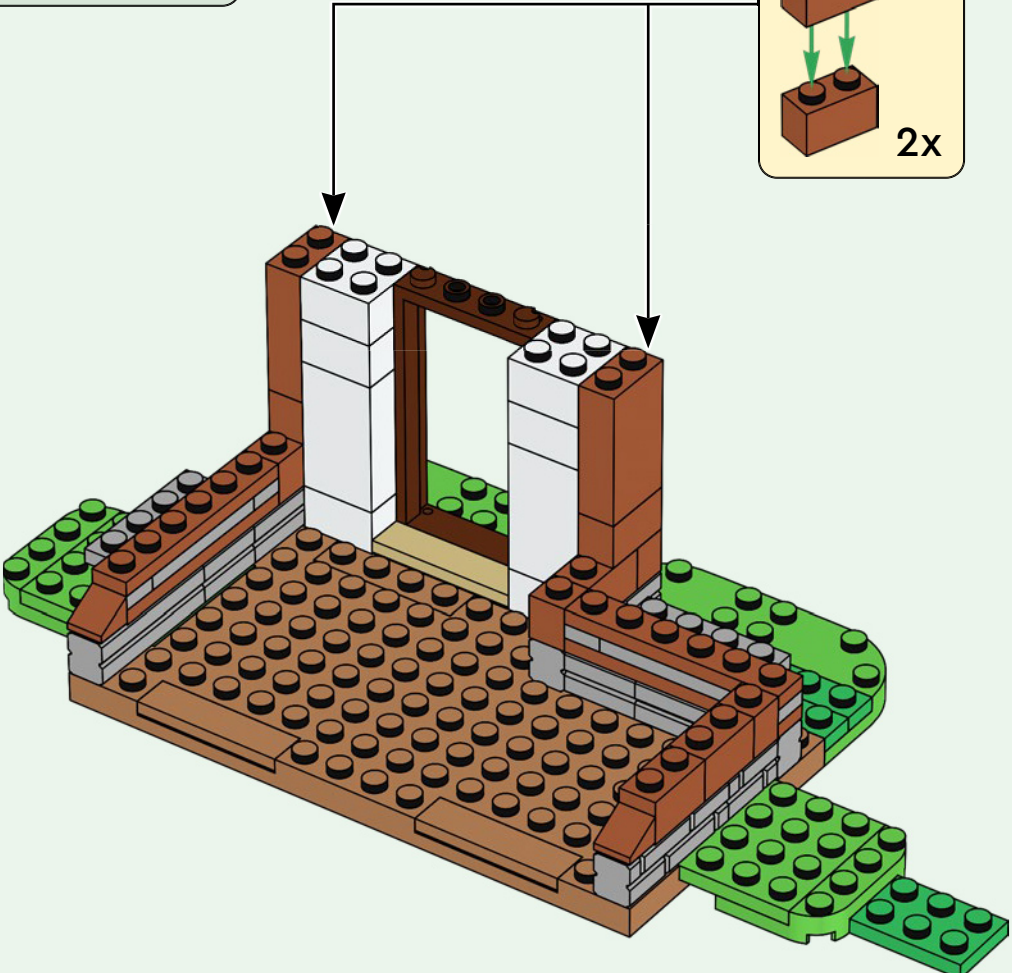
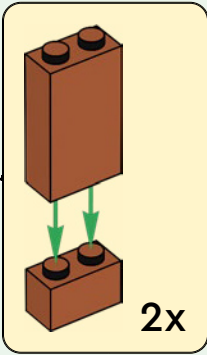



1x

21

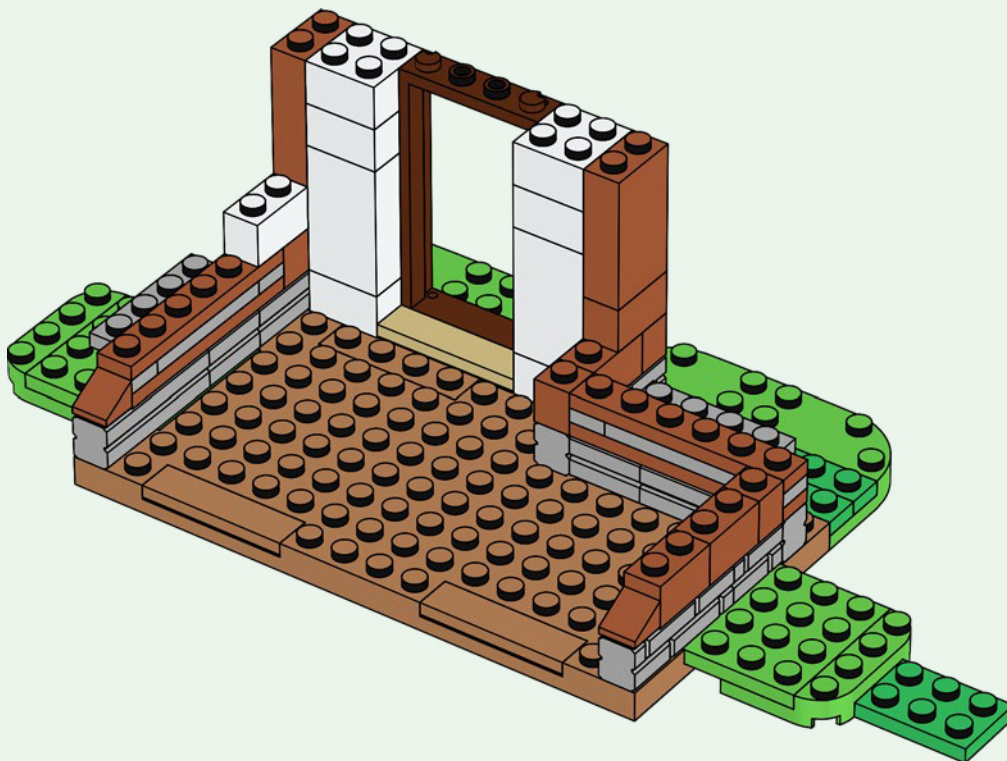



22

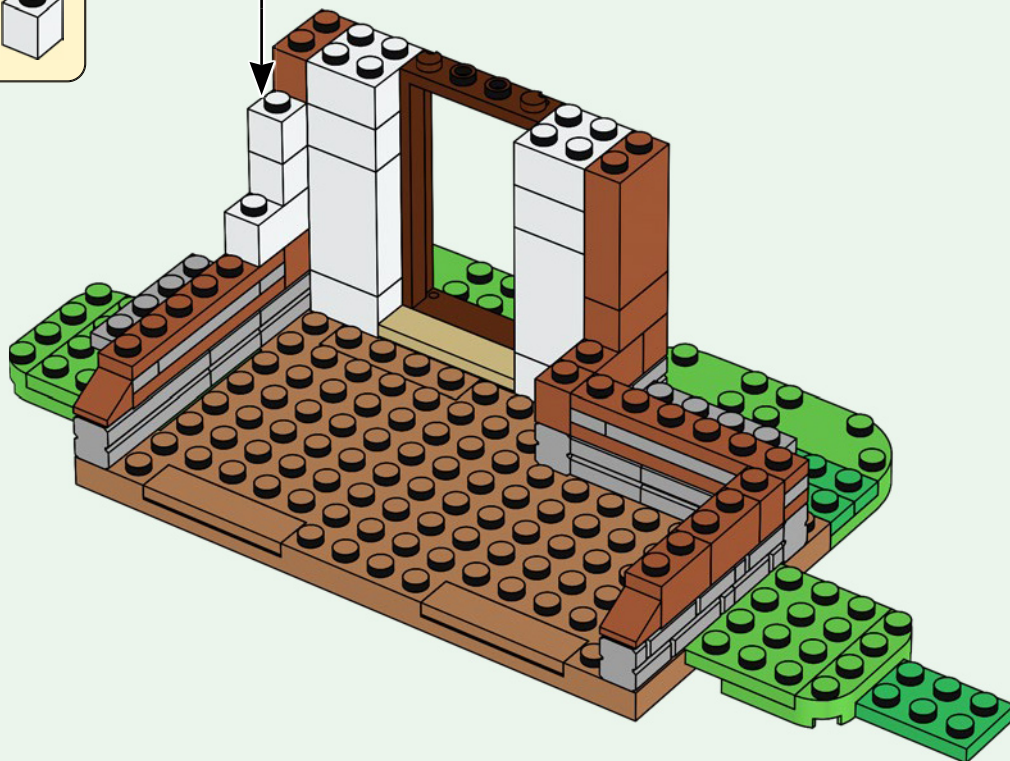
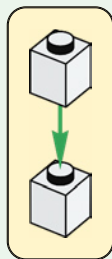



23



2x

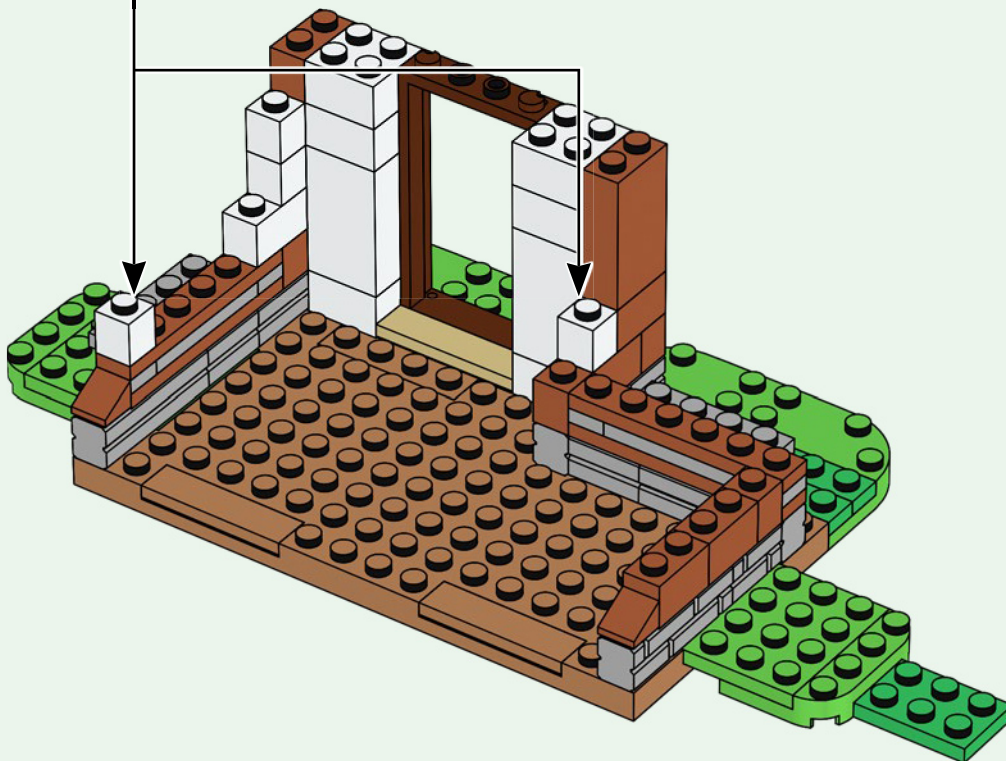

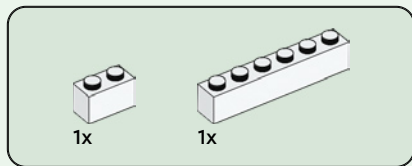

24

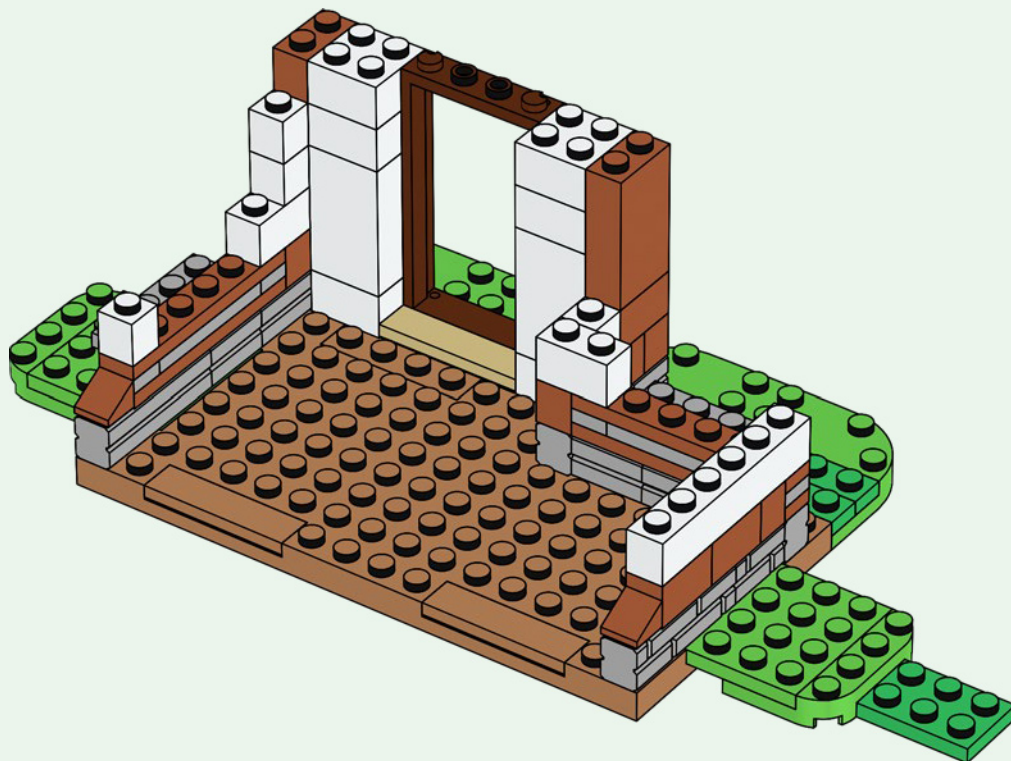



2x

25

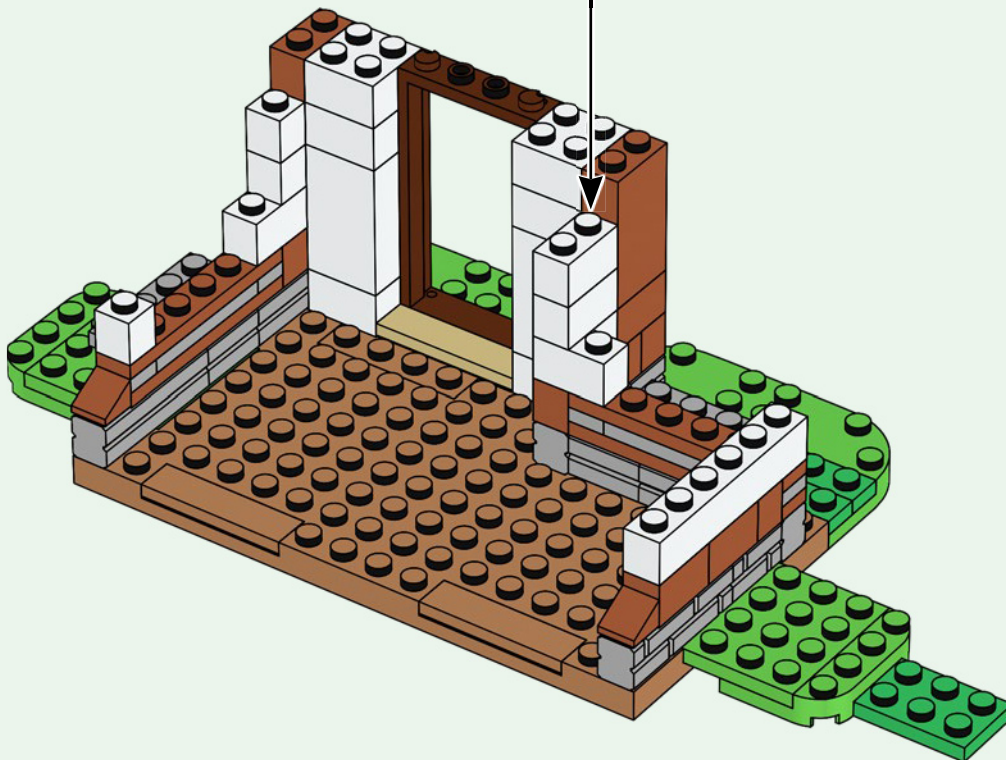
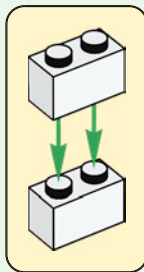

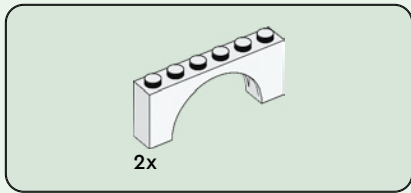

26

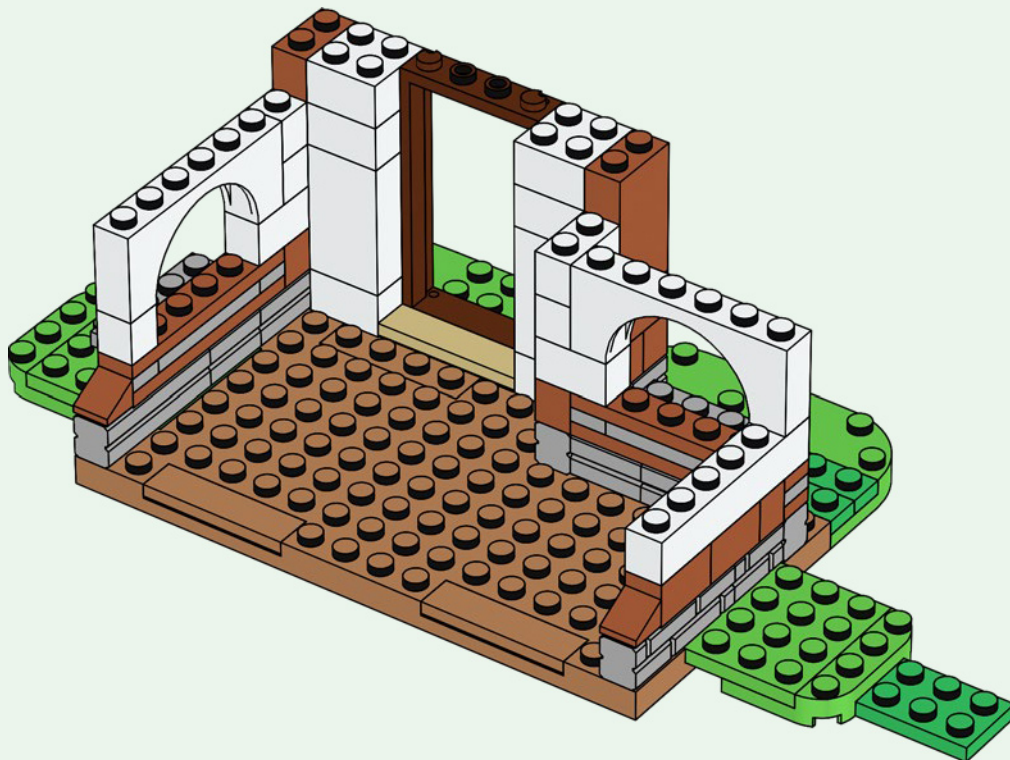



2x



1x

27

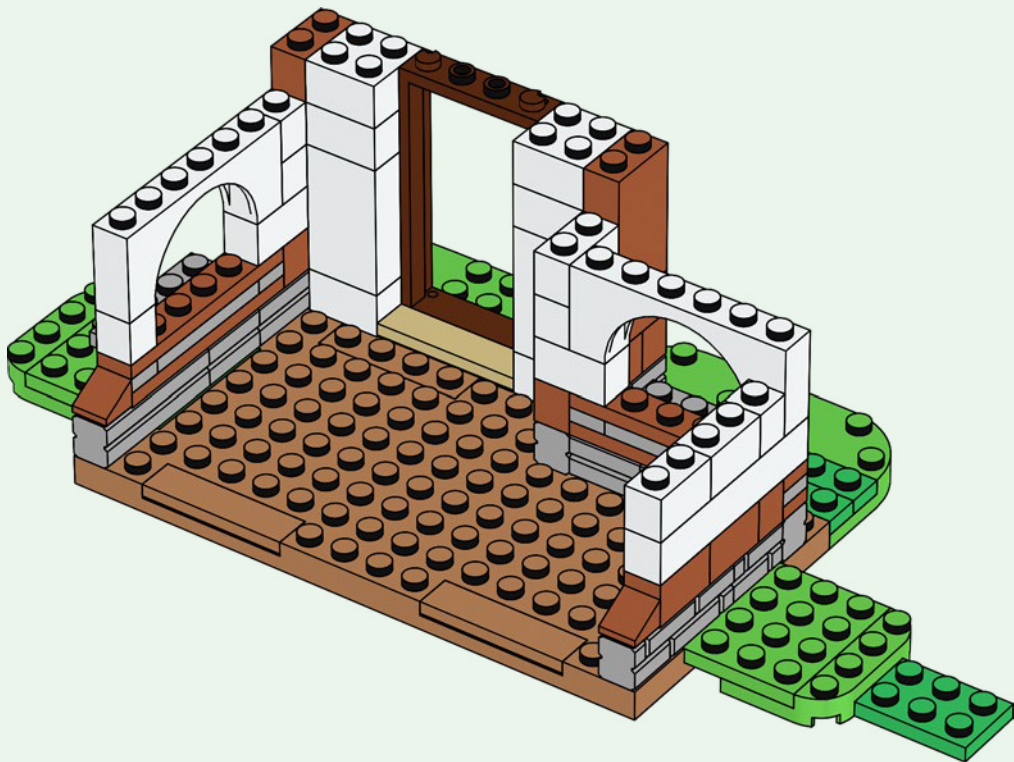

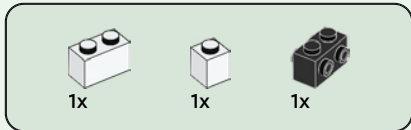

28

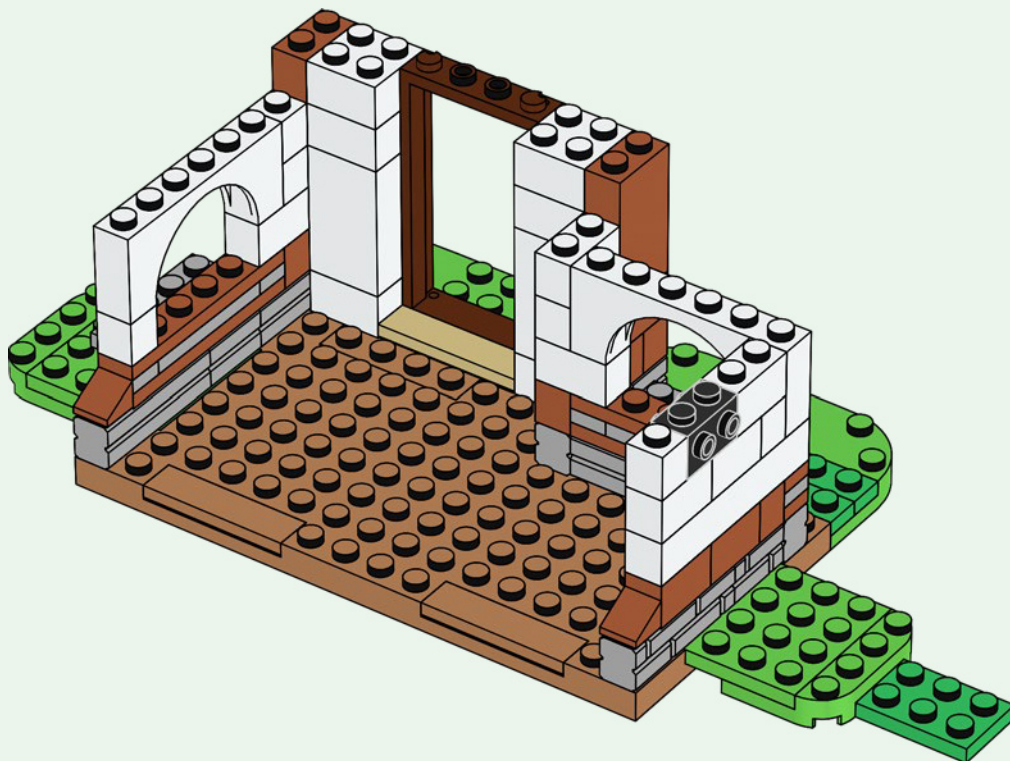

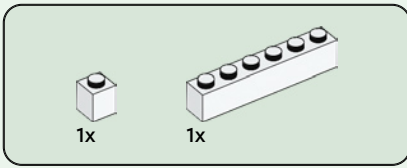

29

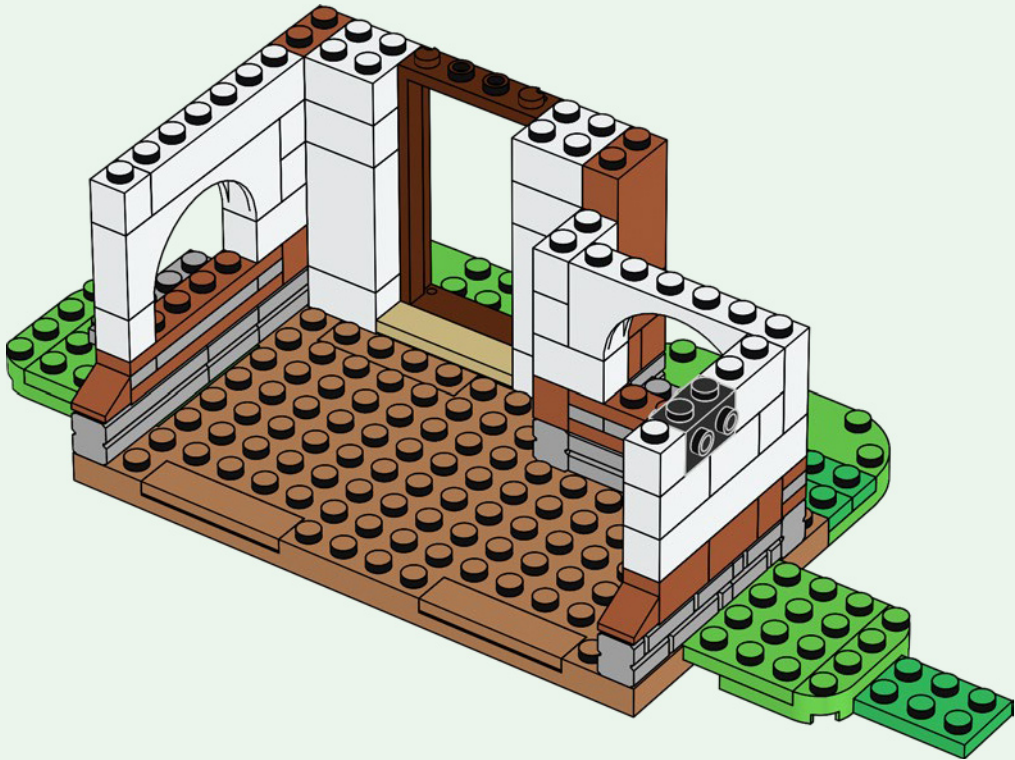

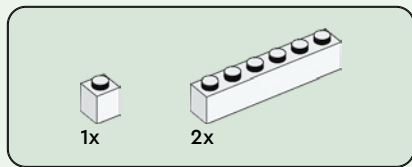

30

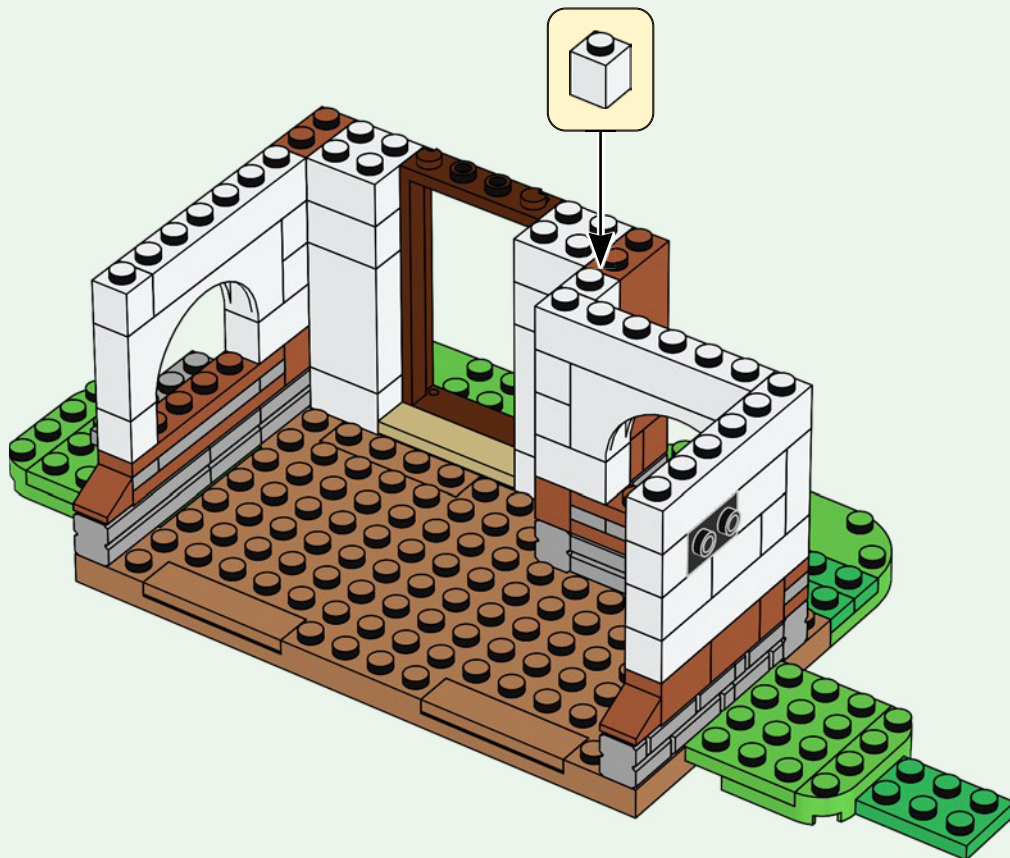

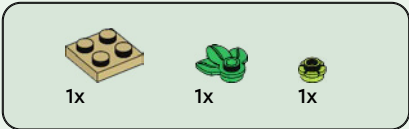

31

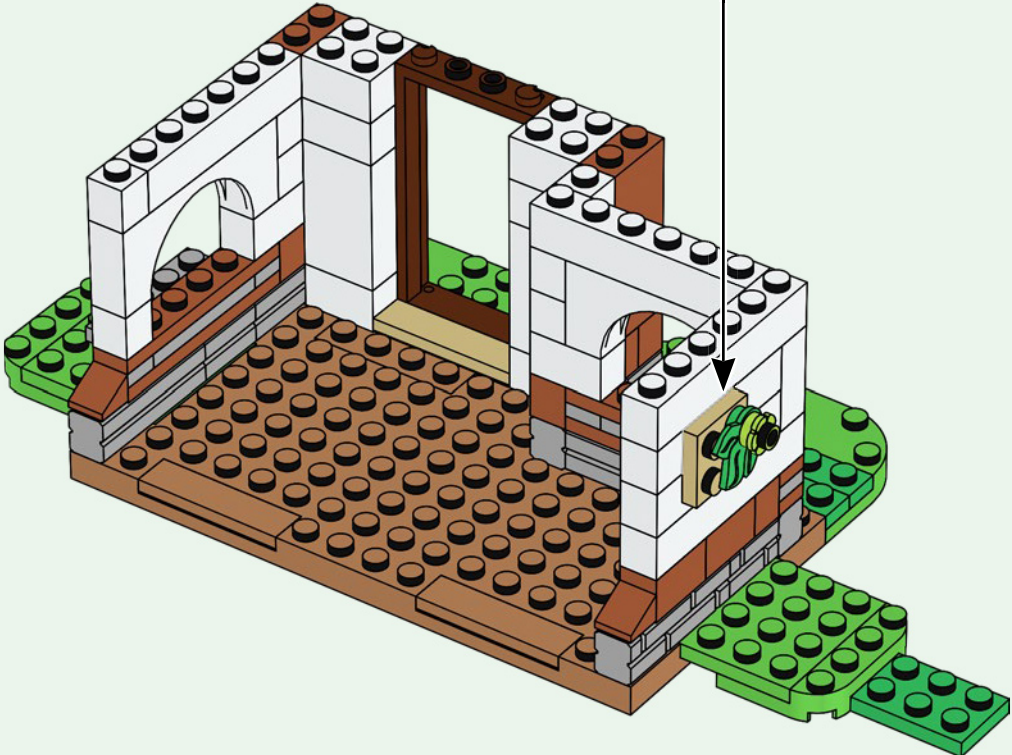
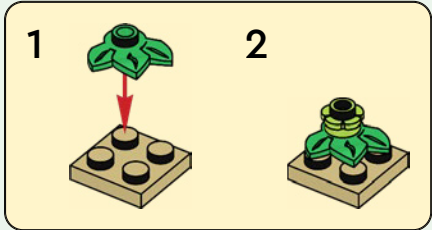



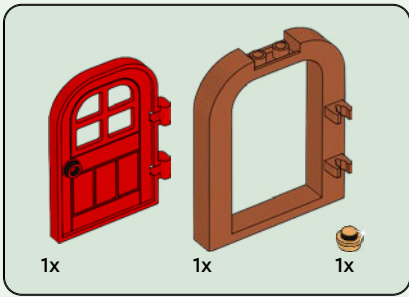

32

1

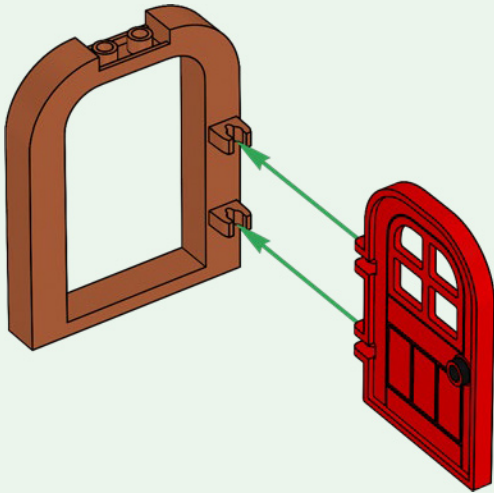

2



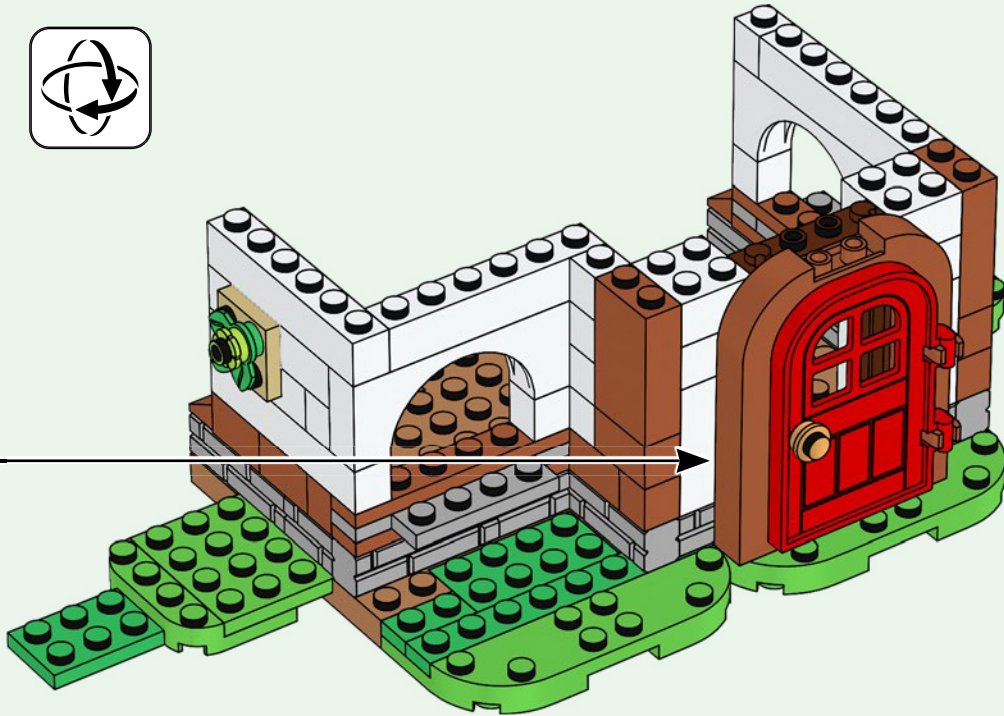

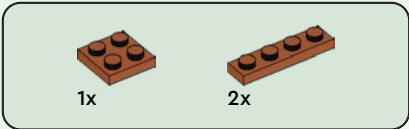

33

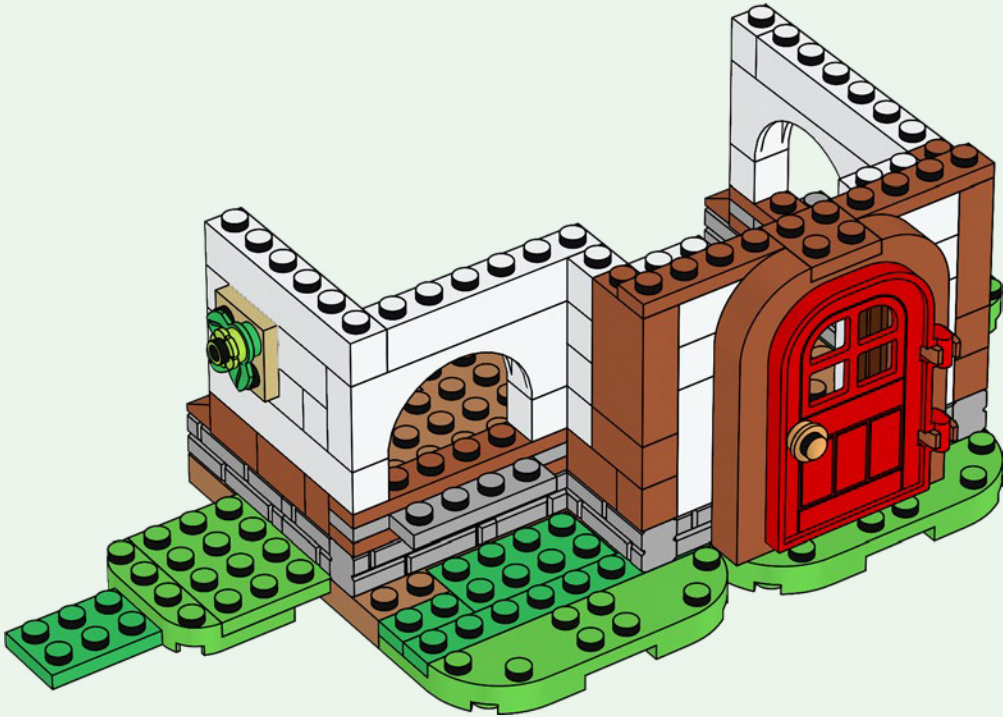

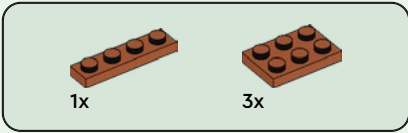

34

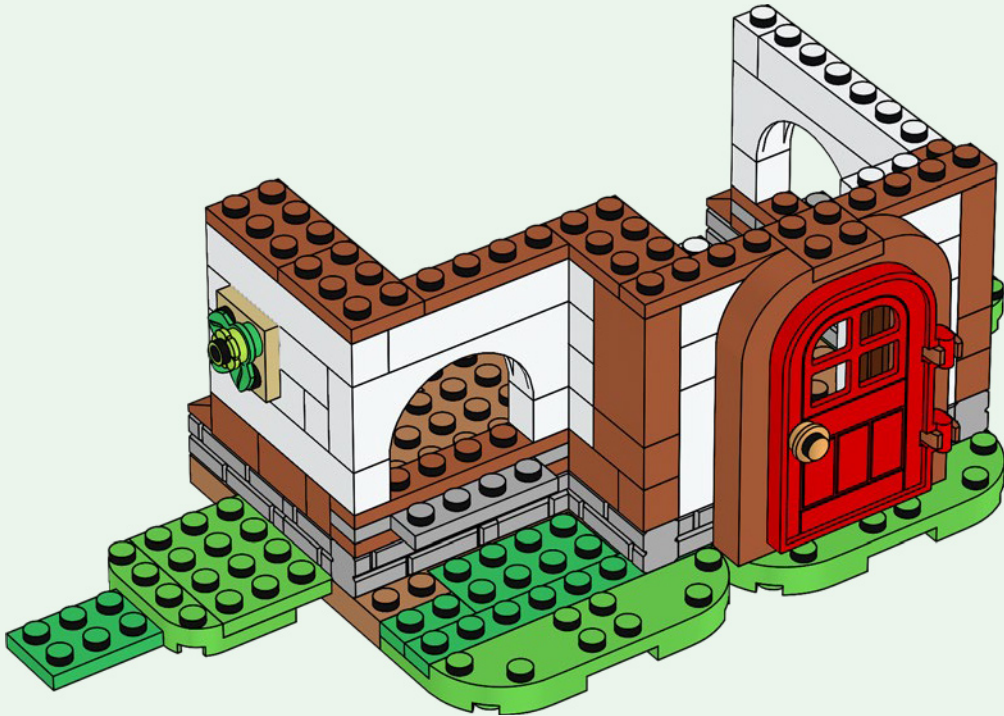



1x



2x

35

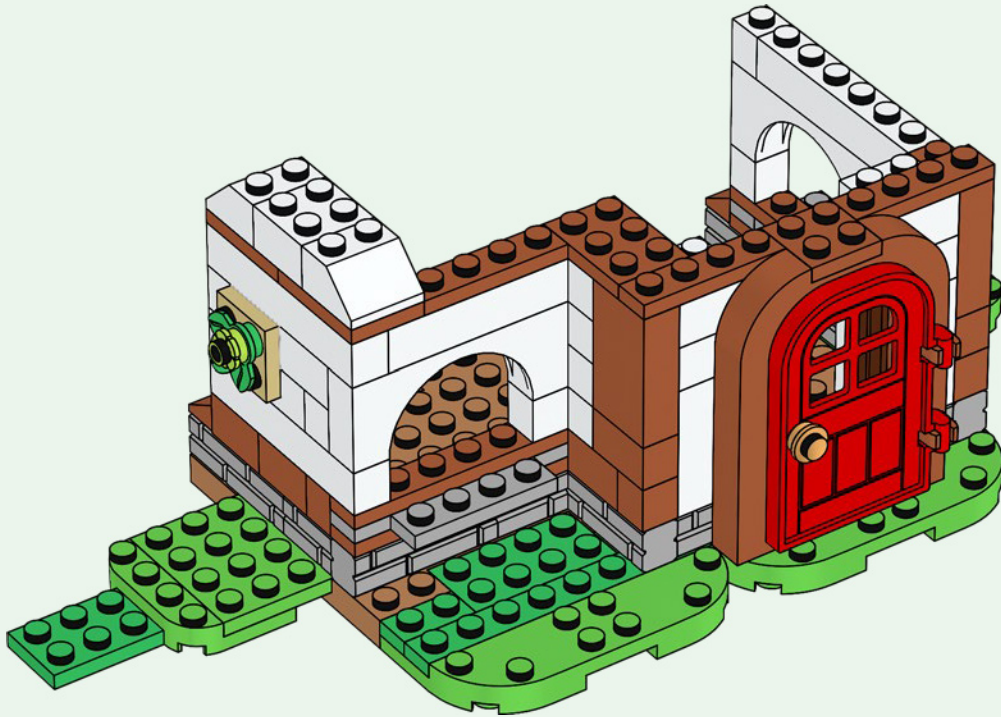



2x

36

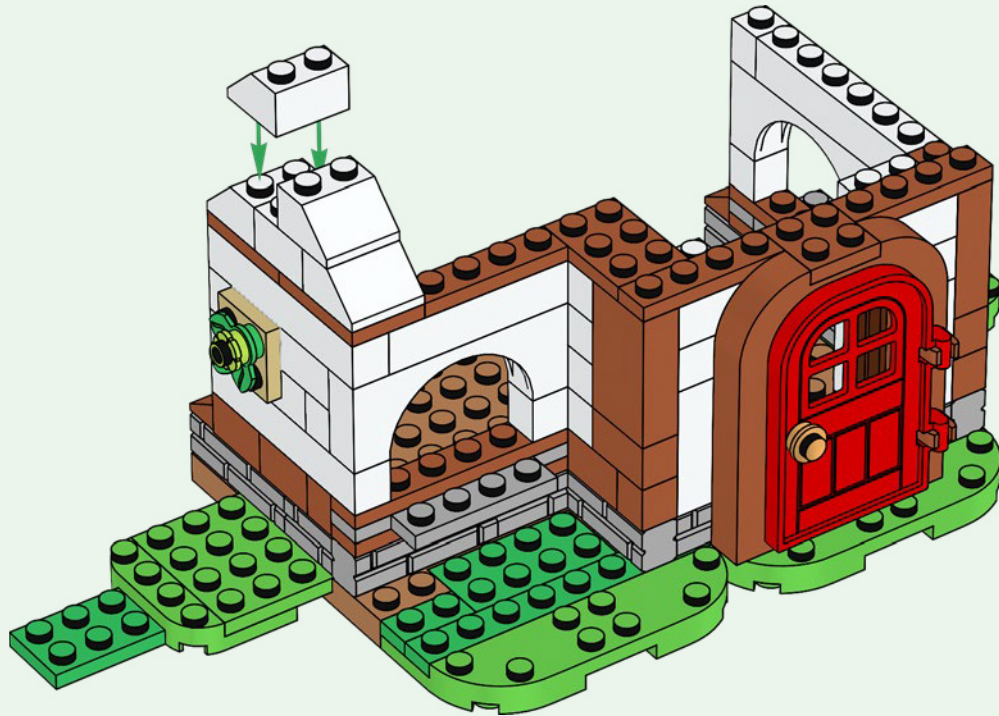



2x

37

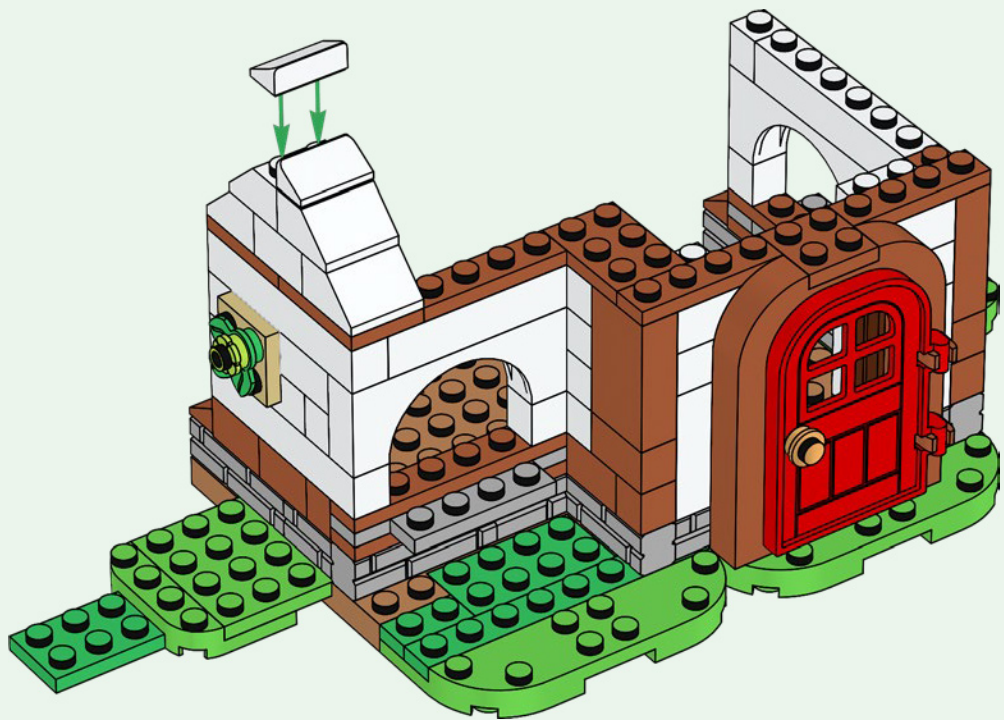

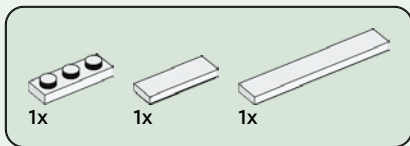

38

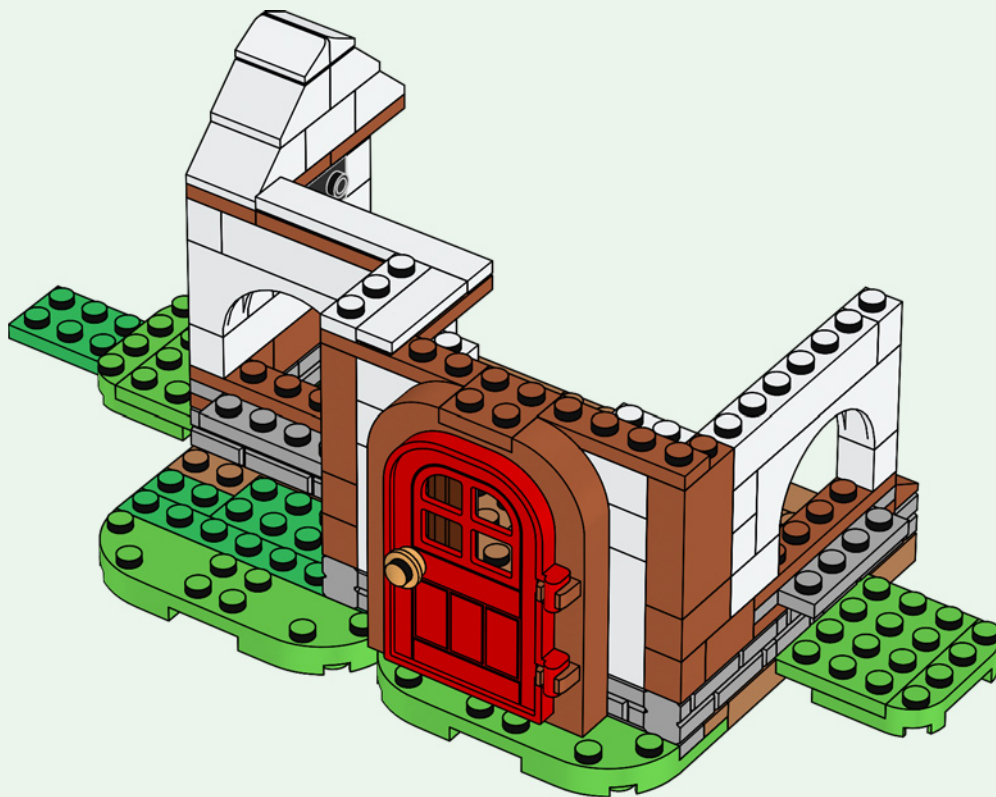



1x



1x

41

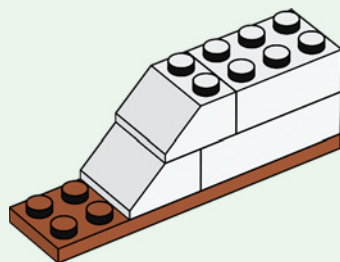



2x

42

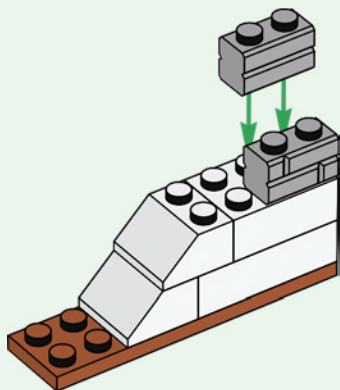

2x

43

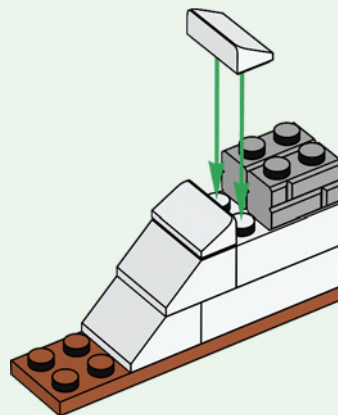



2x

44

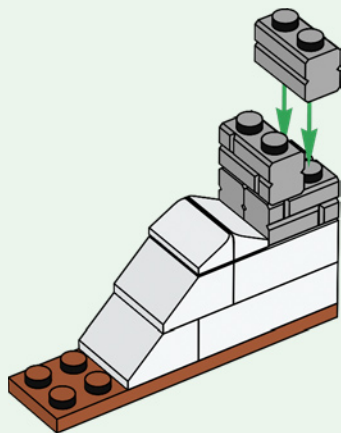

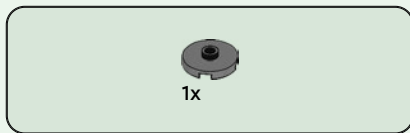

45

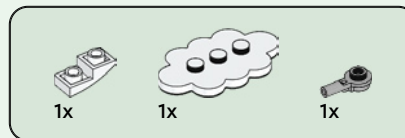
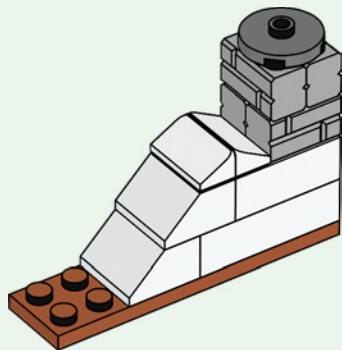

46

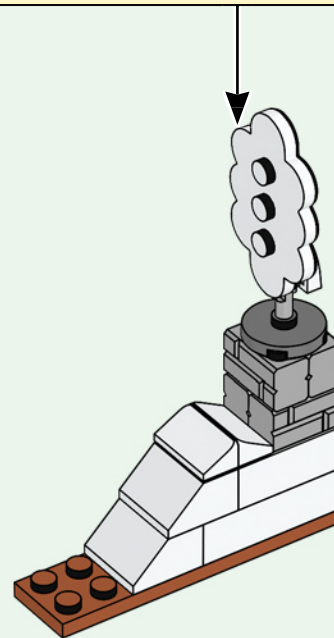
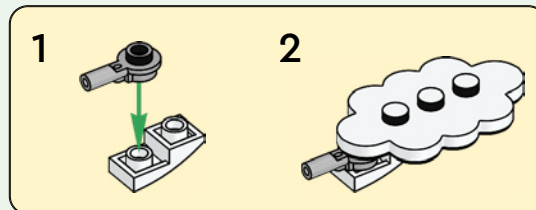

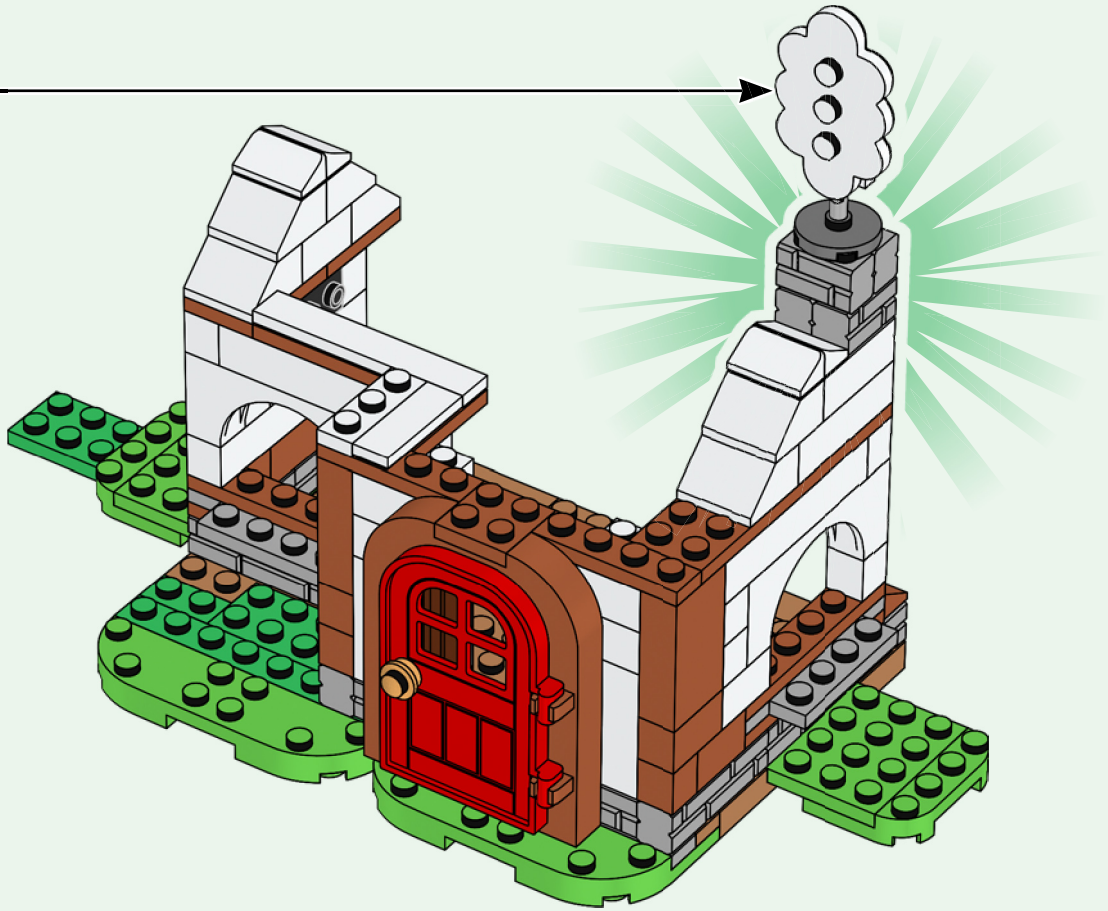

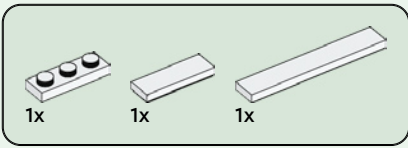

48

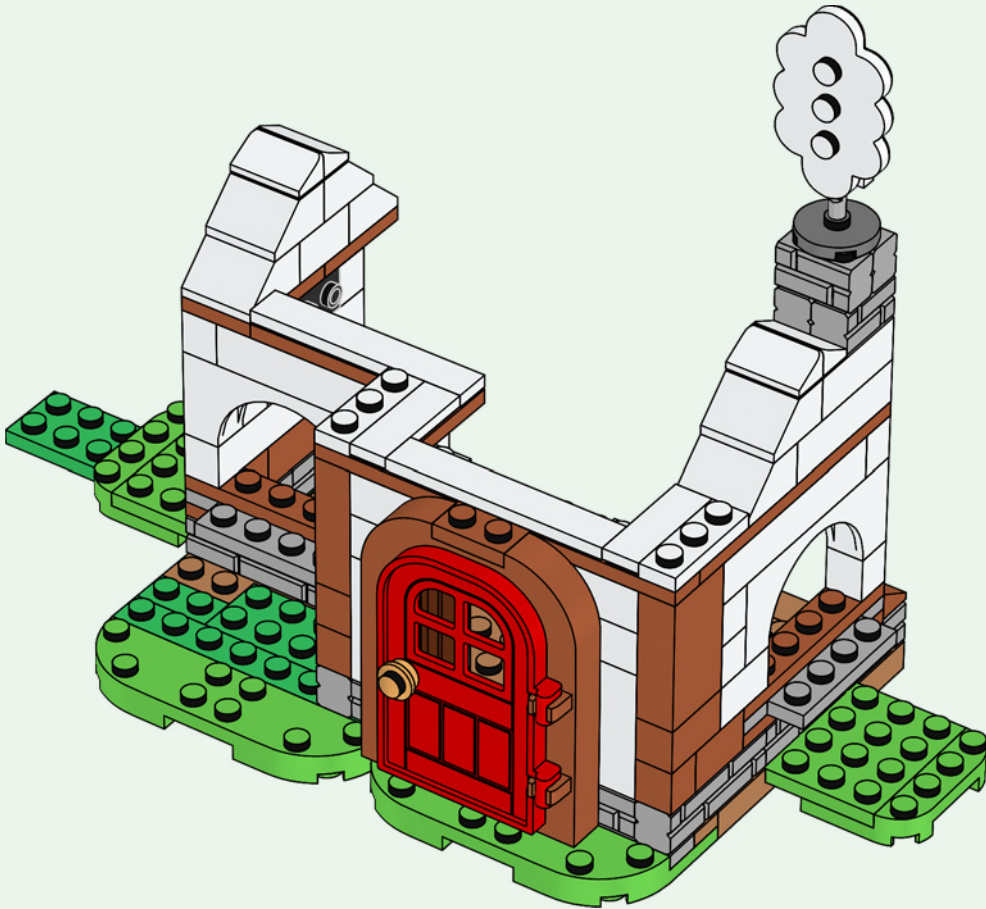

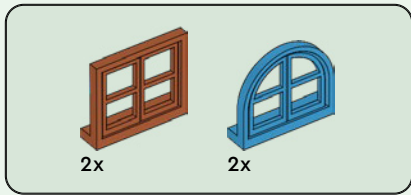

49

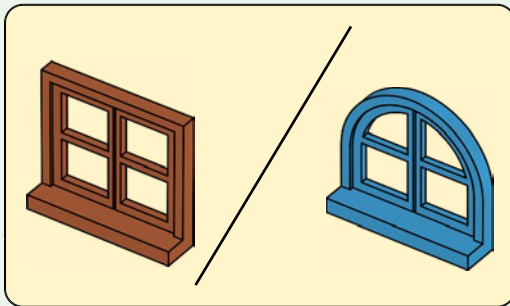

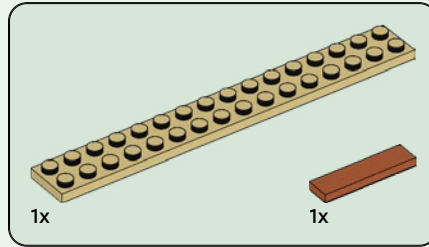
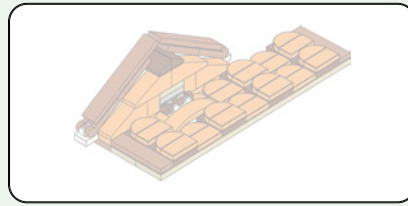

50

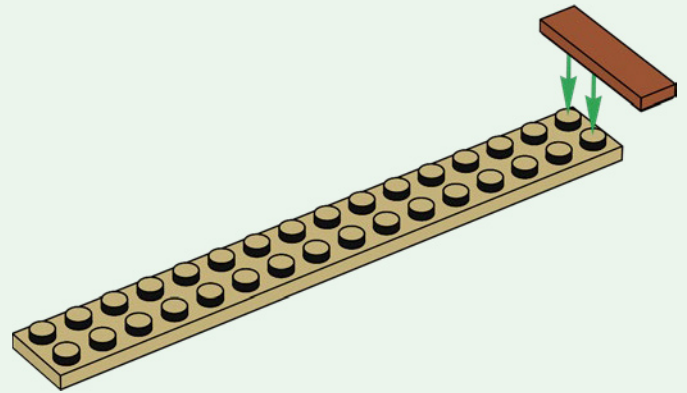

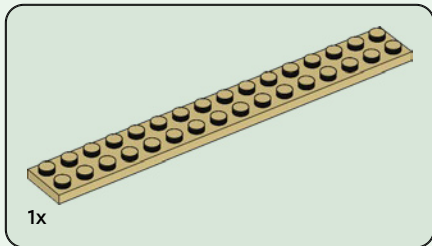

51

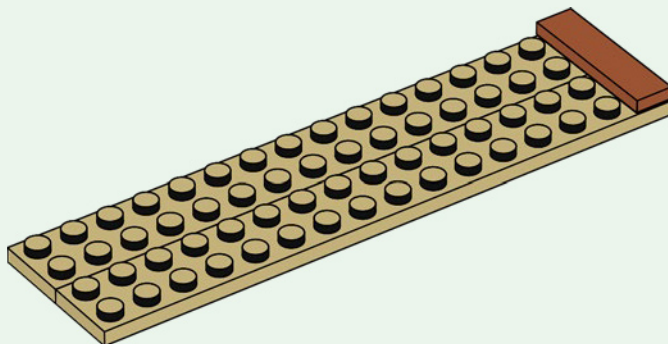

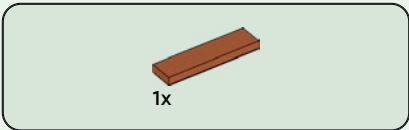

52

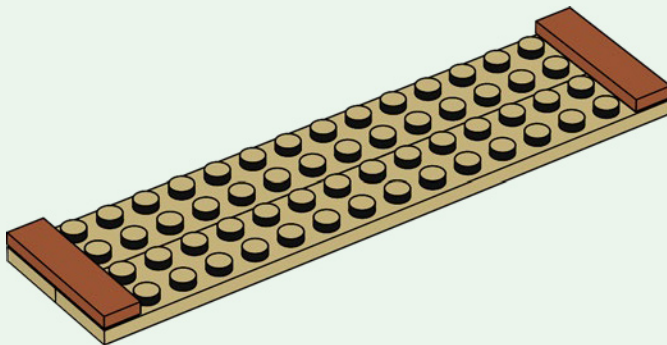

53

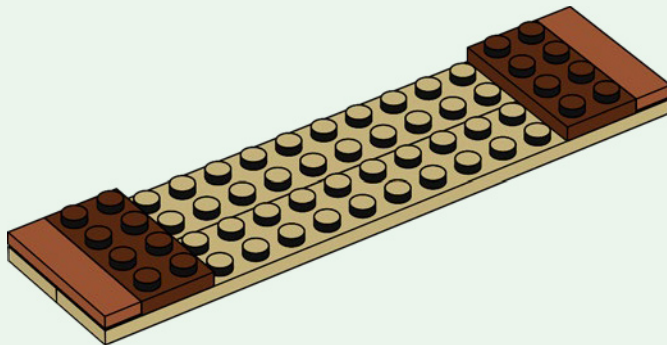

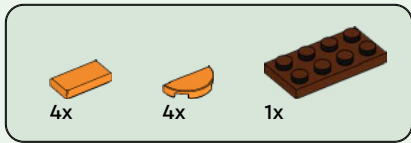

54

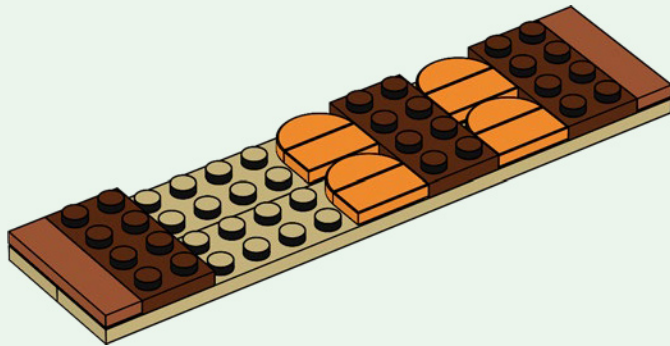

2x

2x

55

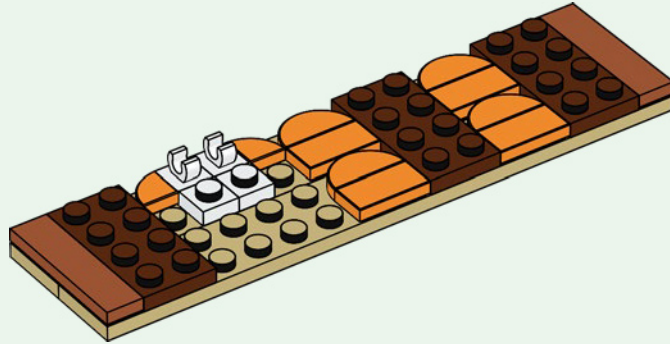

1x

56

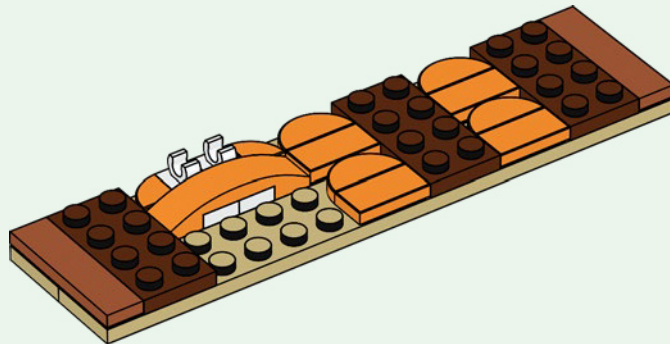



57

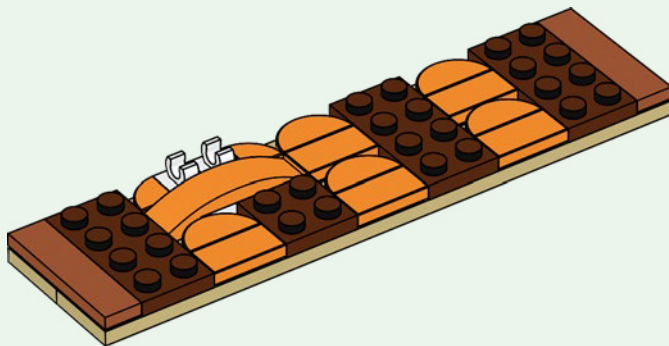



7x



7x

58

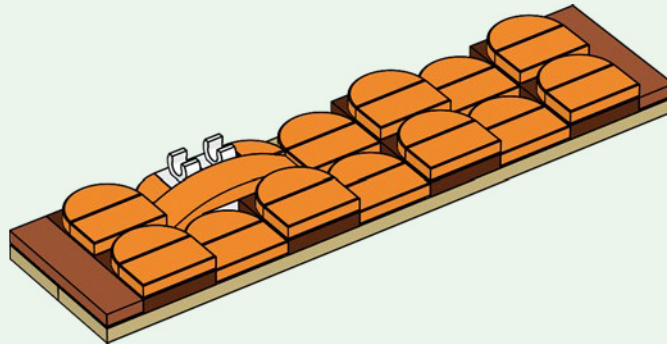

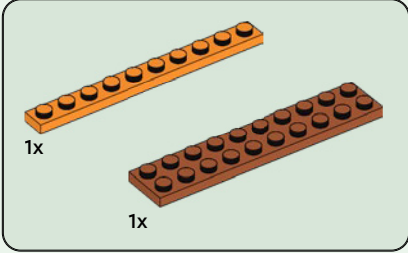
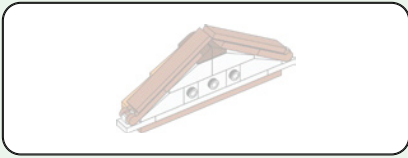

59

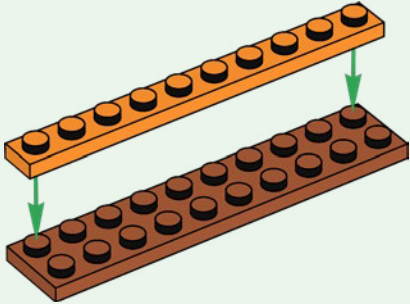

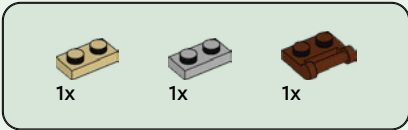

63

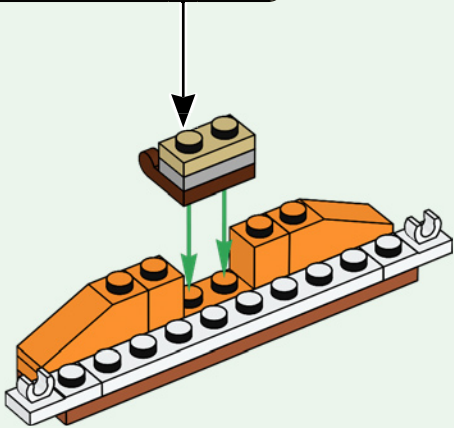
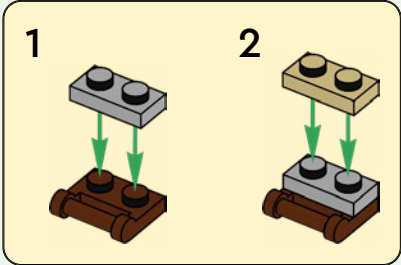



1x

64

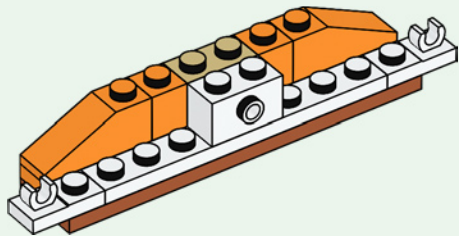

2x



2x

65

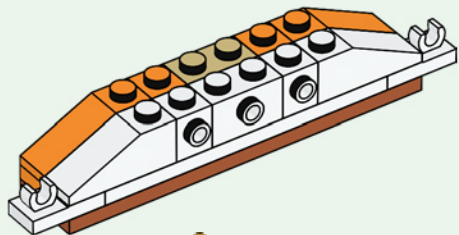

2x



2x

66

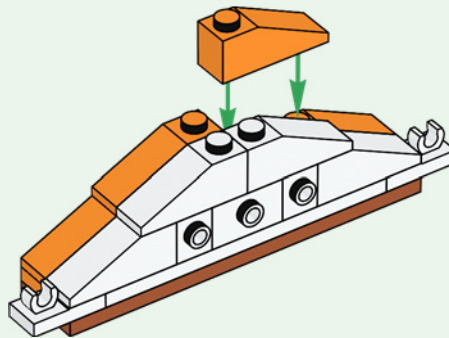

2x

67

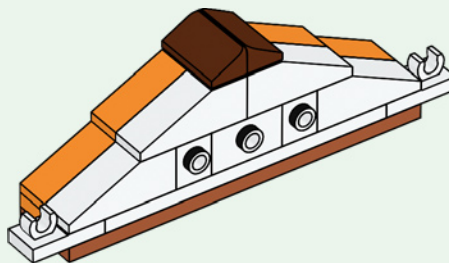

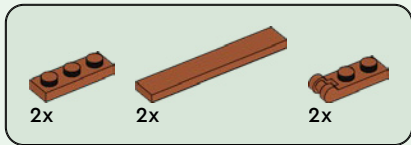

68

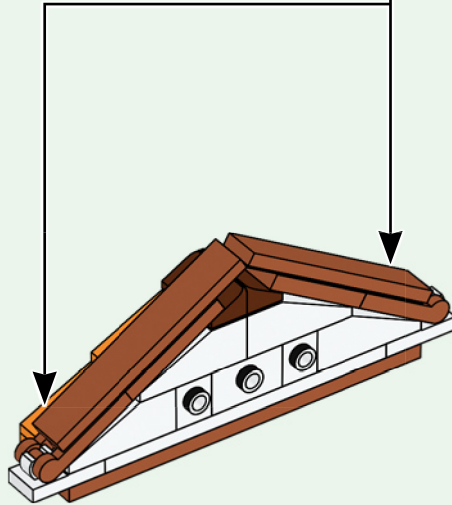
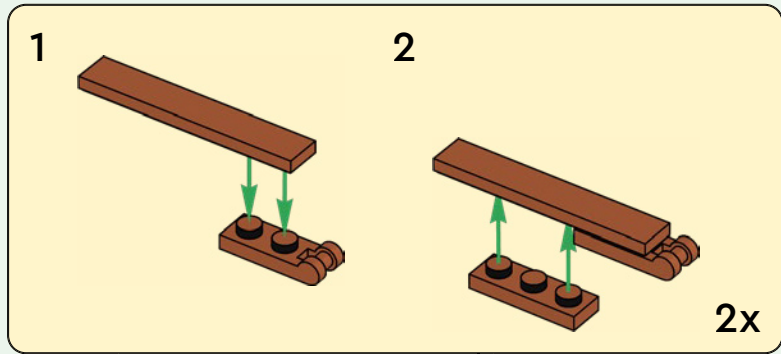

69

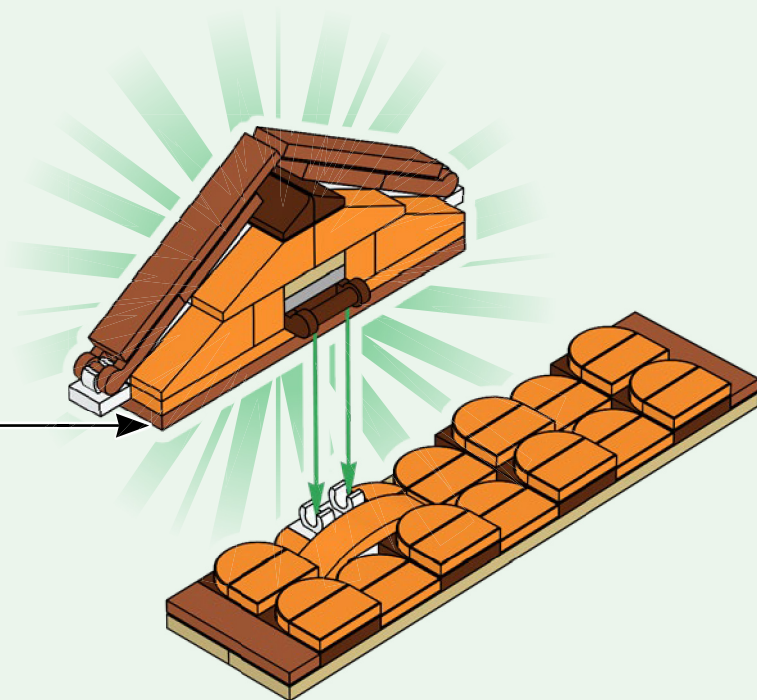

70

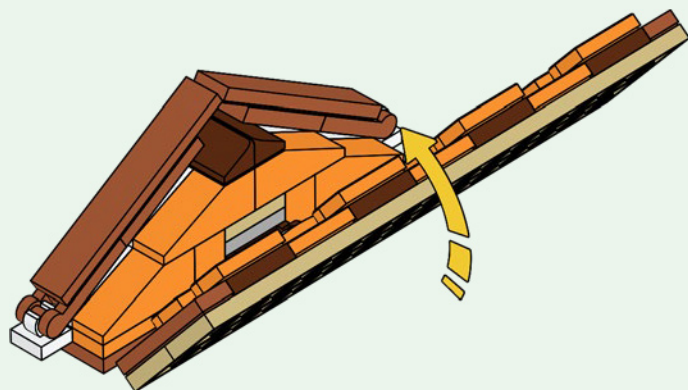

71

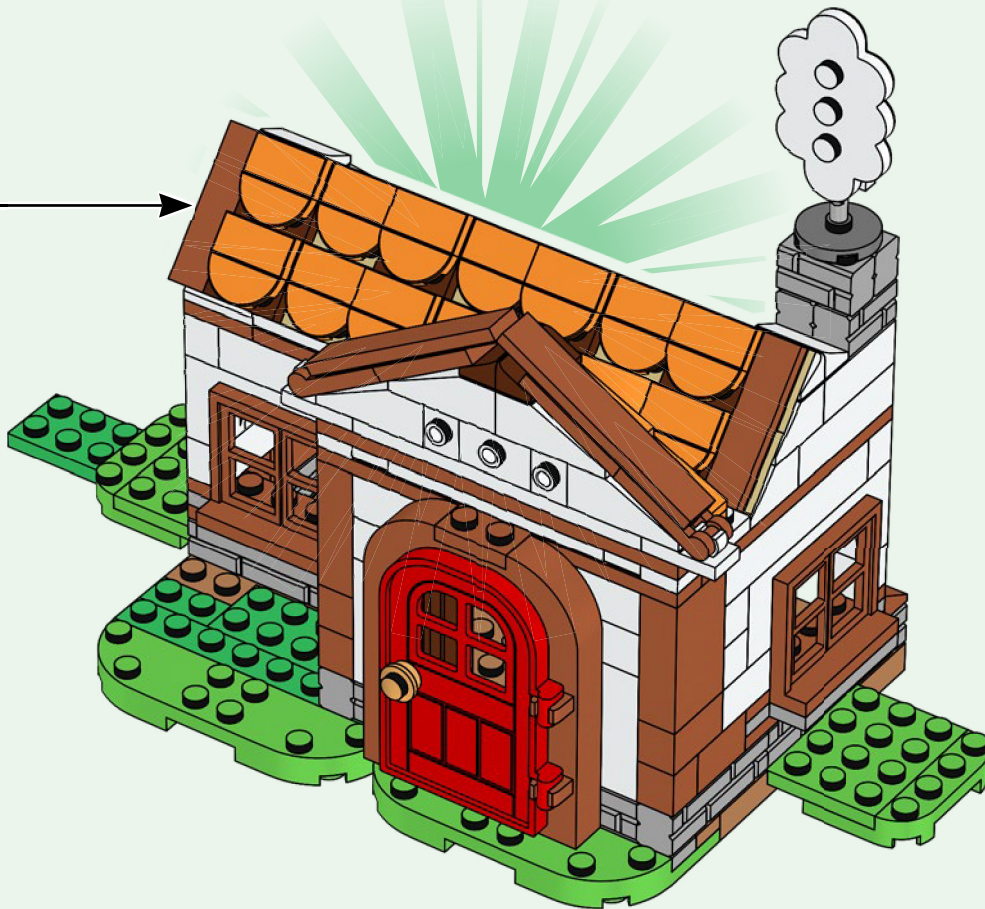





2x



1x

72





1x

73

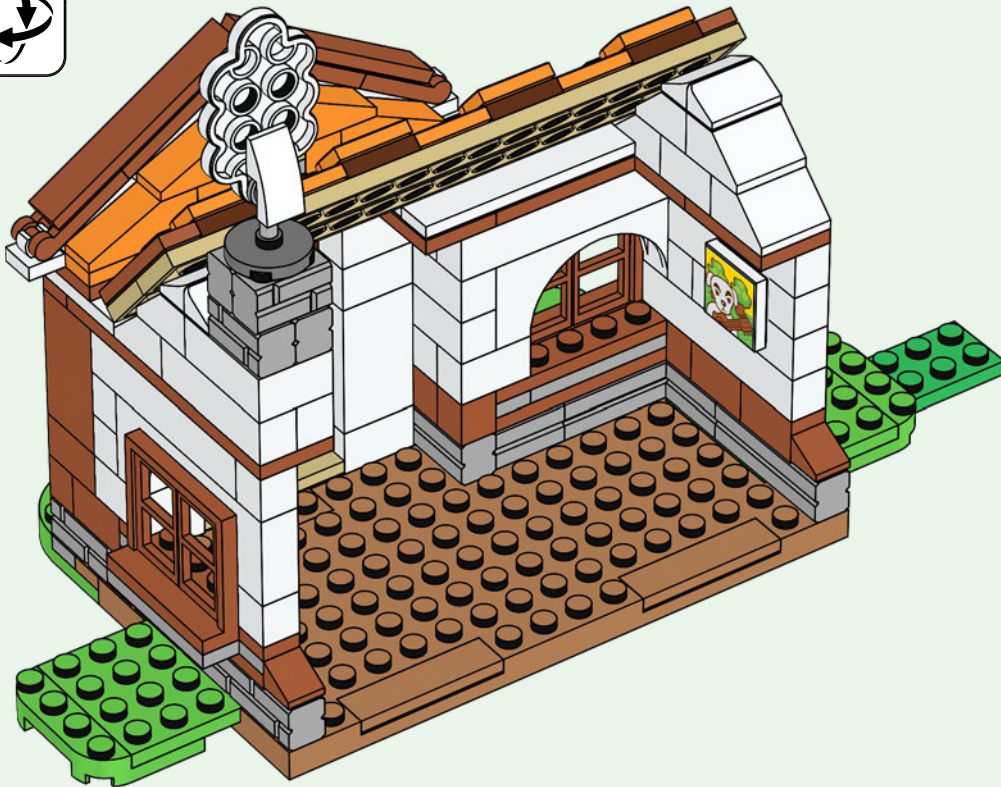

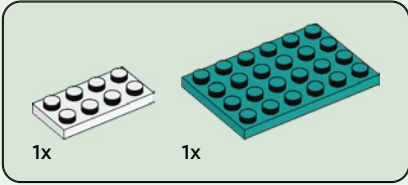
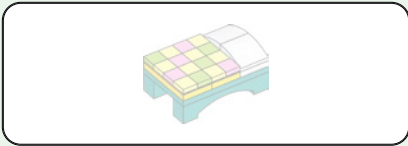

74

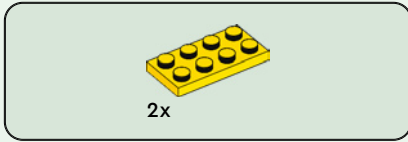
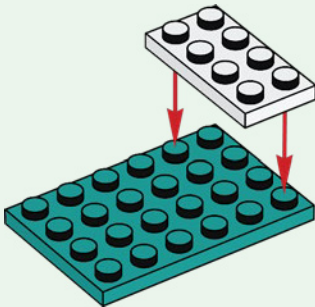

75

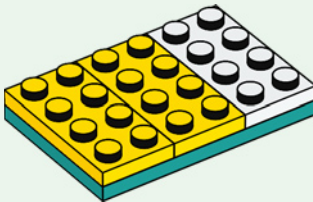



1x

76

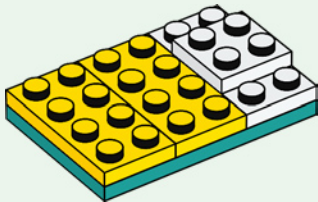

2x

77

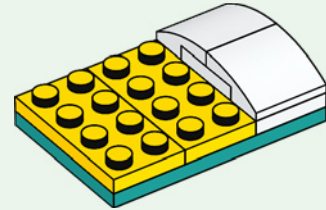

4x



4x



8x

78

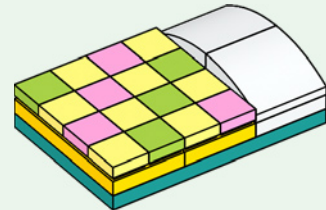

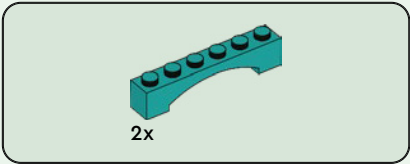

79

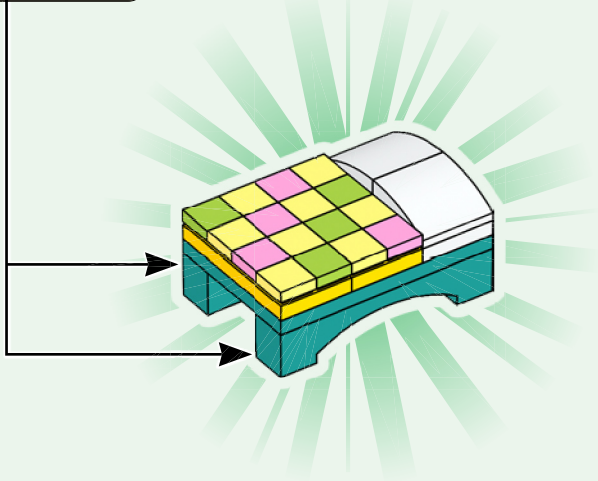
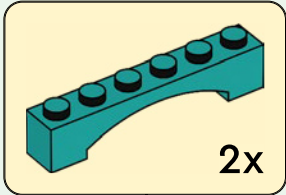

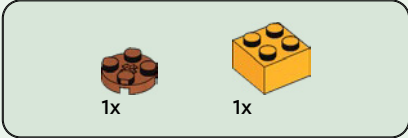

80

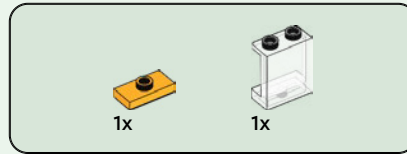

81



82



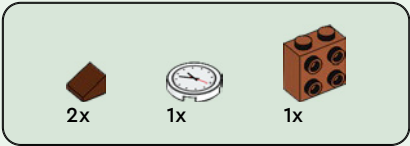

83

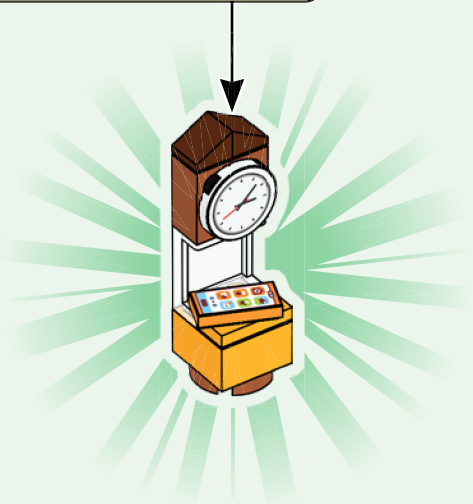
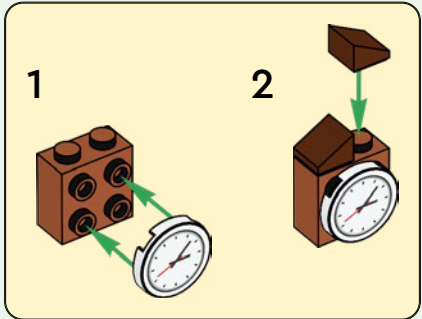

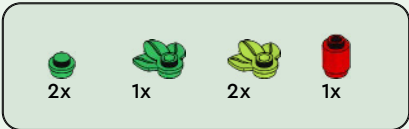

84

1



2



3



4



5



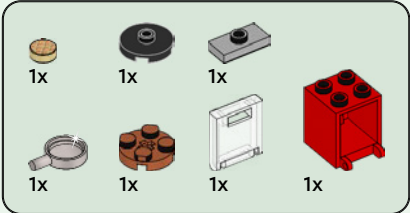

85

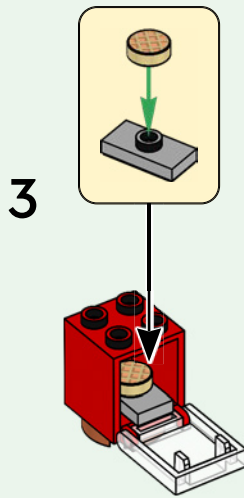
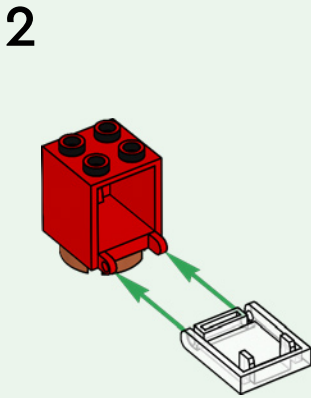
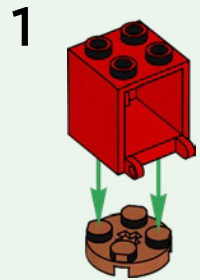

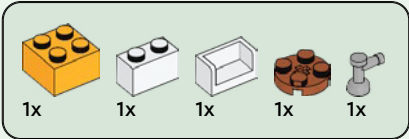
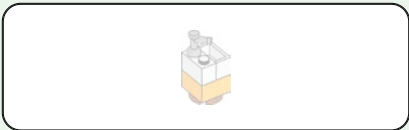

86

1

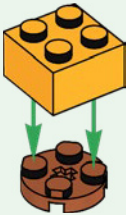

2

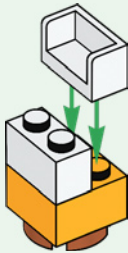

3

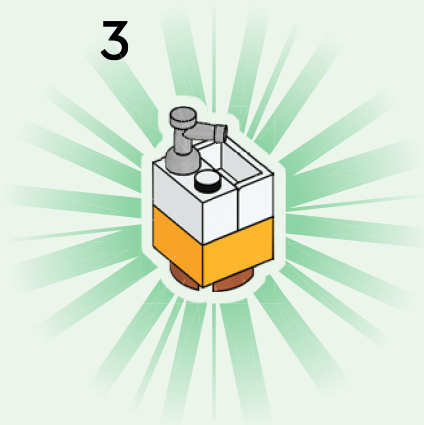

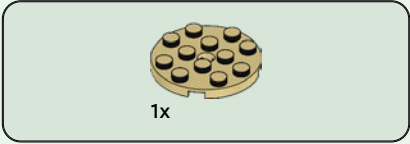

87

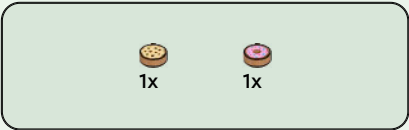
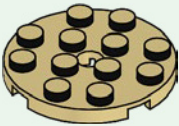

88





1x



2x

89



1x

90

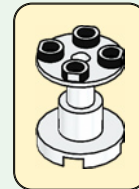

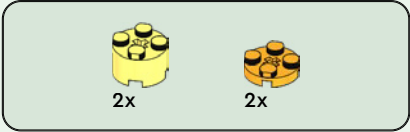
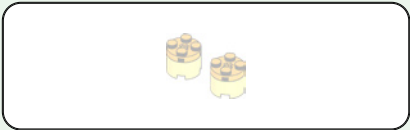

91

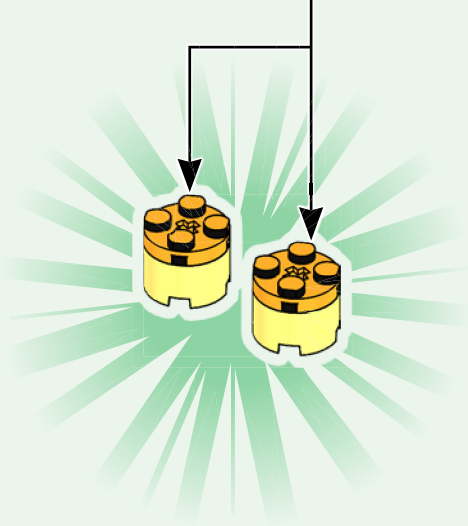
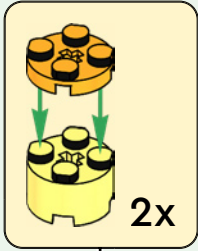

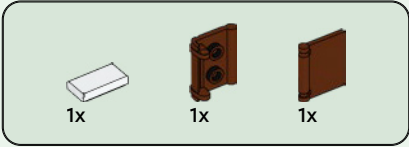
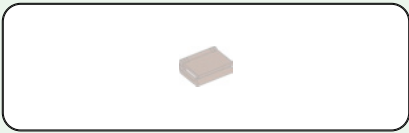

92

1

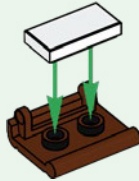

2











3x



3x

93

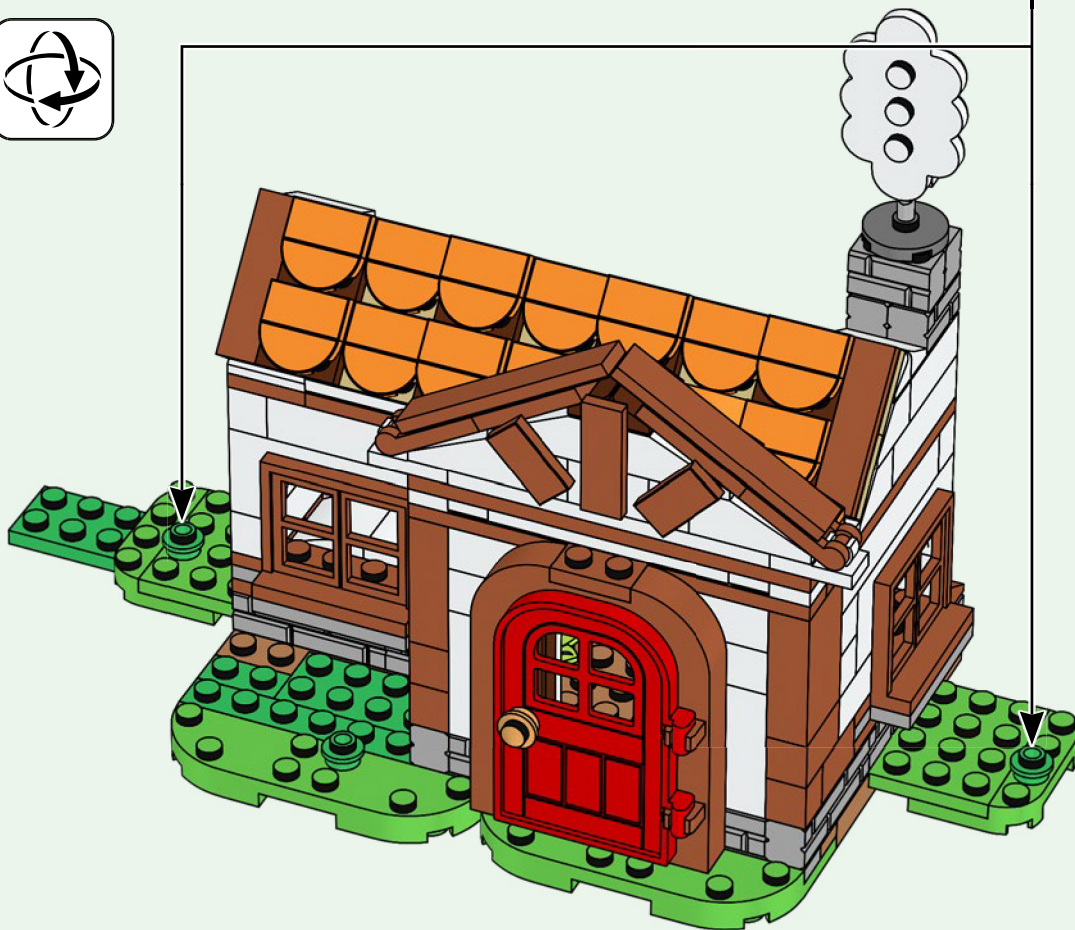

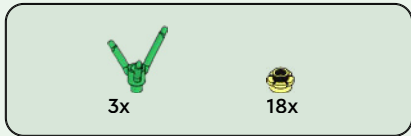
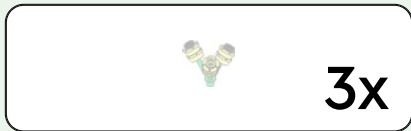

94

1



2

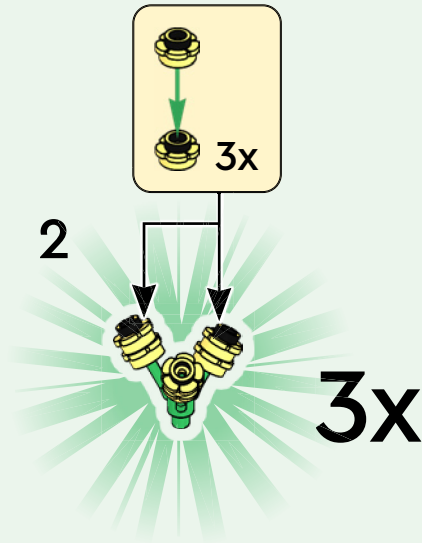



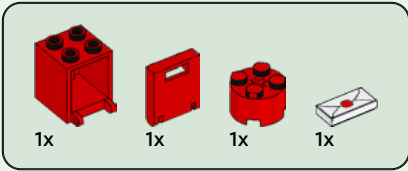

95

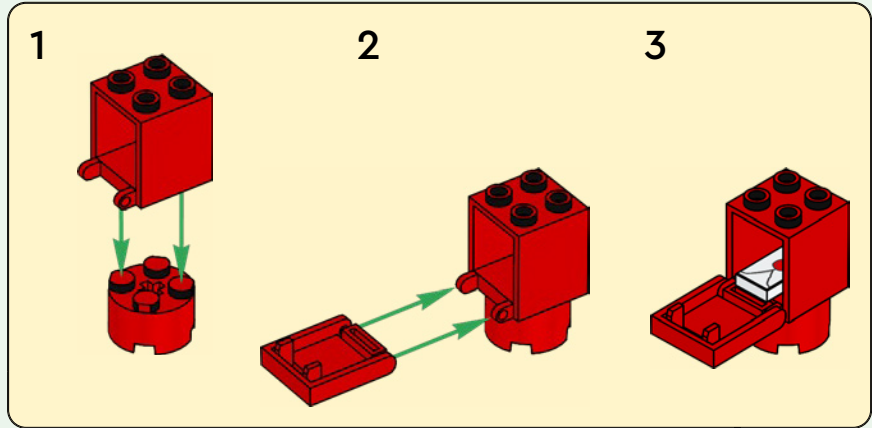

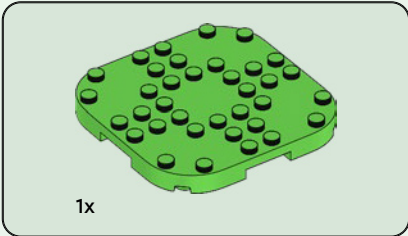
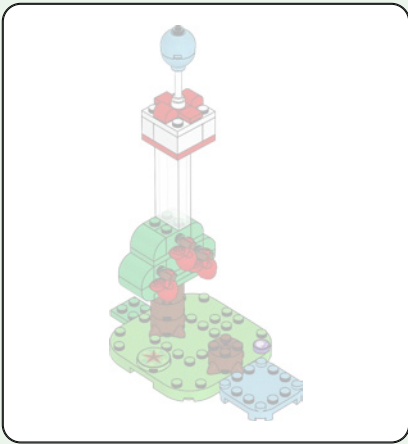

1x

96

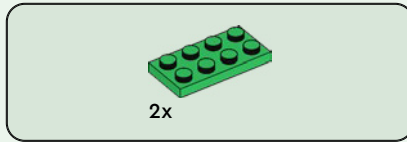
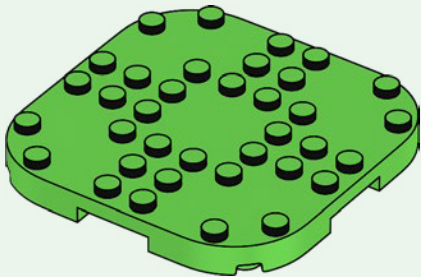

2x

97

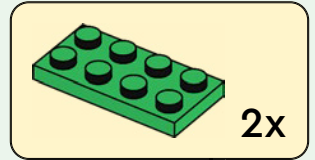

2x

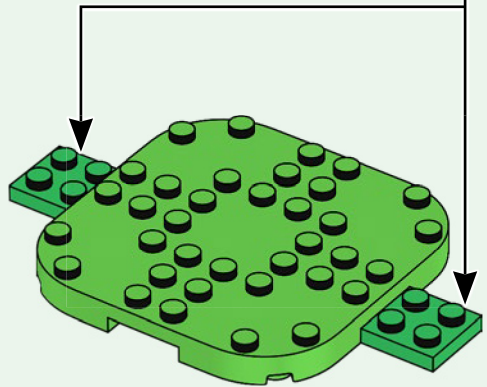

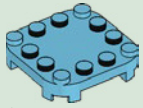

1x

98

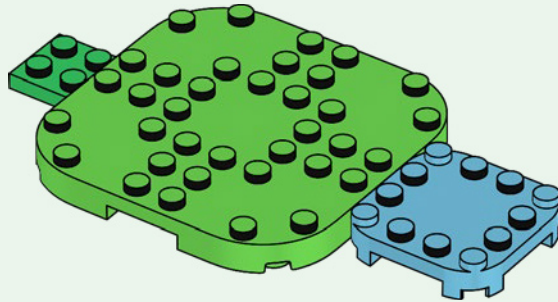



99

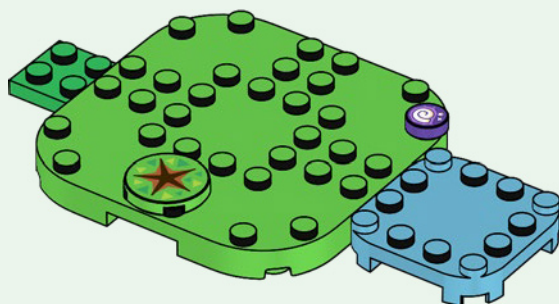

100

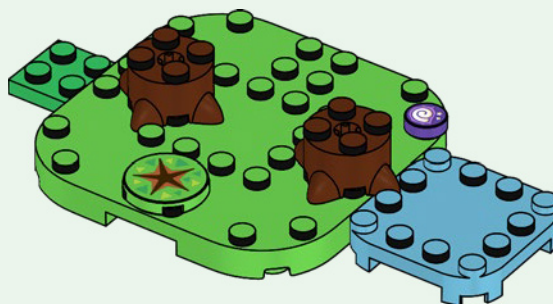



2x

101

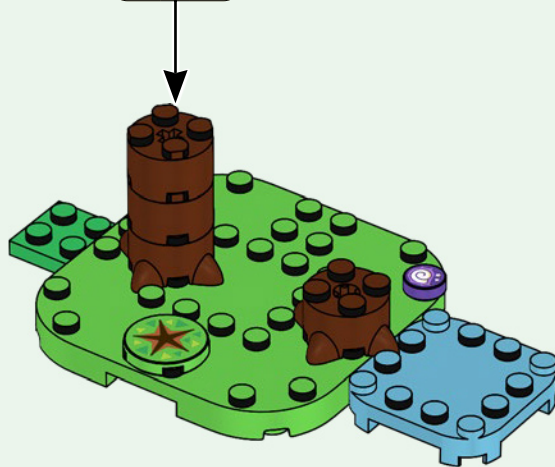
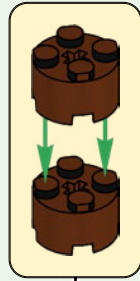

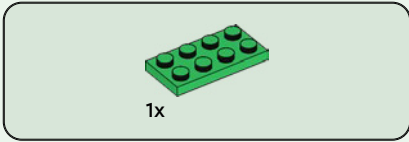
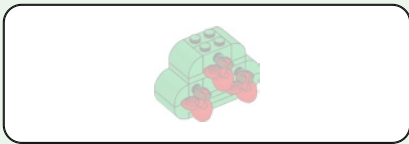

1x

102

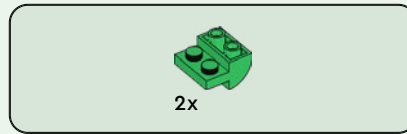
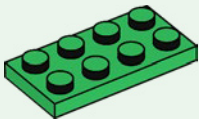

2x

103

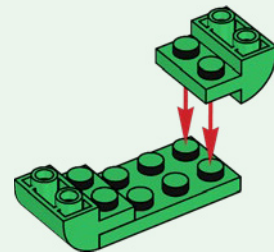



1x

104

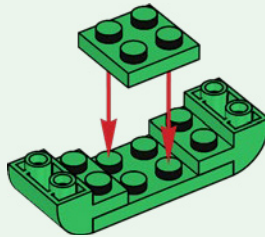

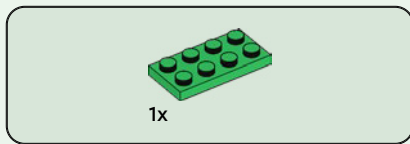

105

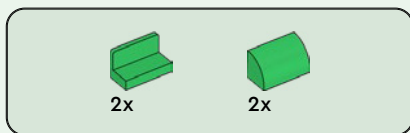
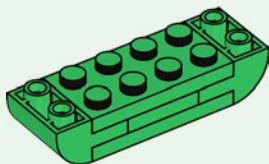

106

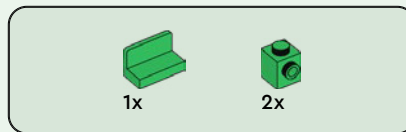
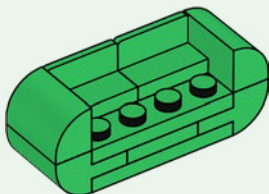

107

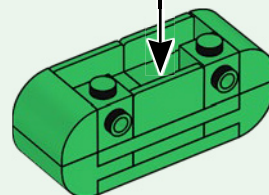
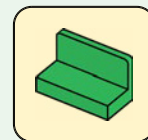



1x

108

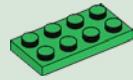
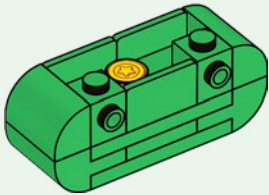

1x

109

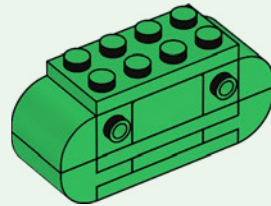

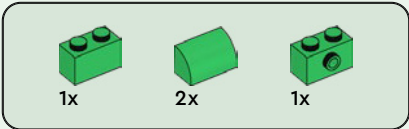

110

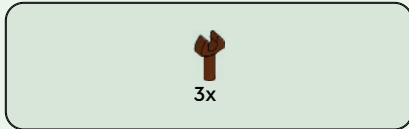
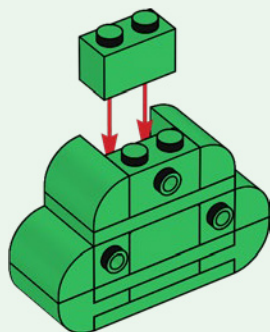

111

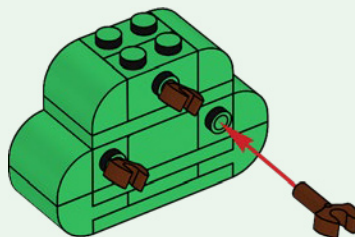



3x

112

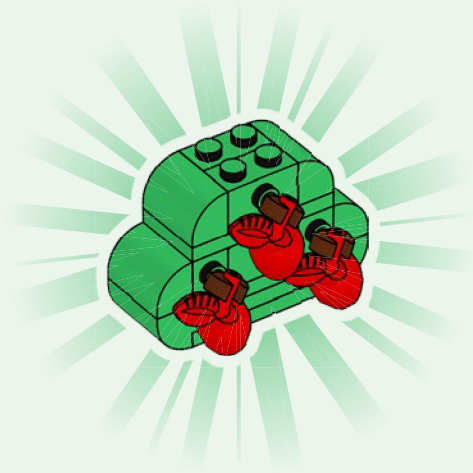

113

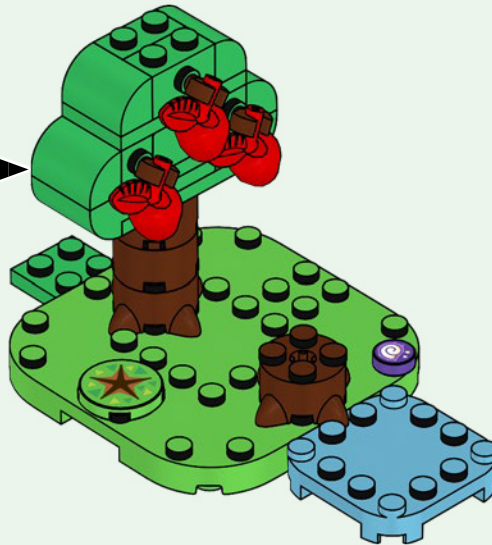

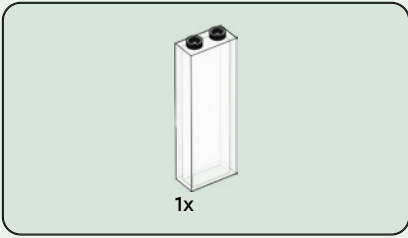

114

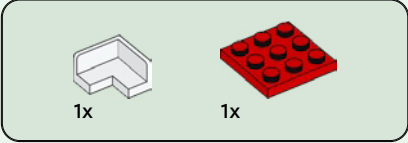
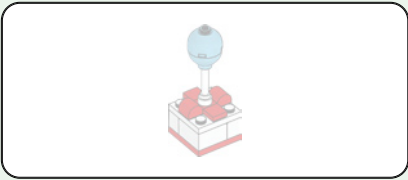
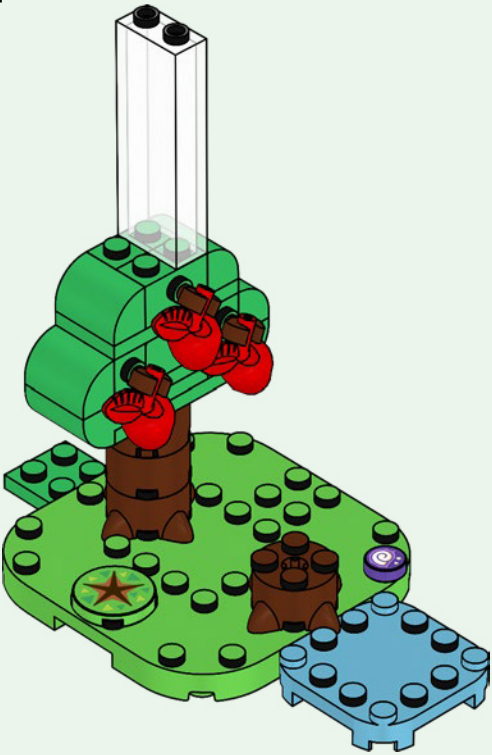

115

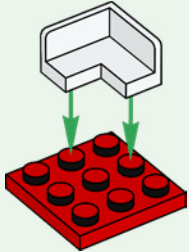



1x



1x



1x

116

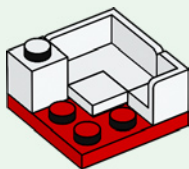

1x

117

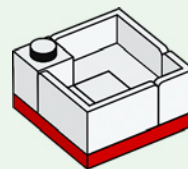

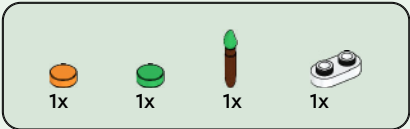

118

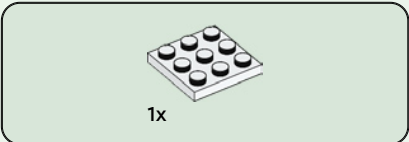
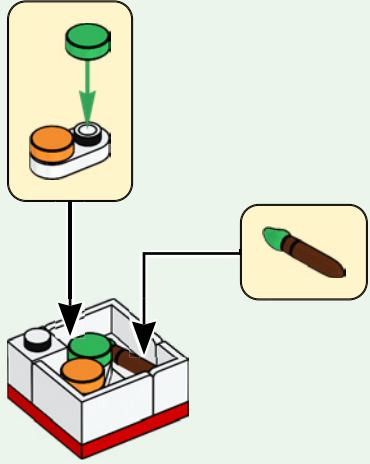

119

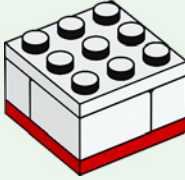



1x



2x

120

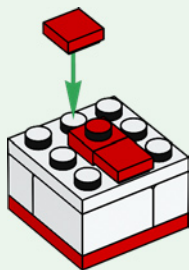

2x

121

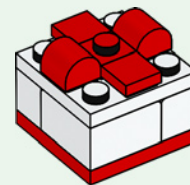

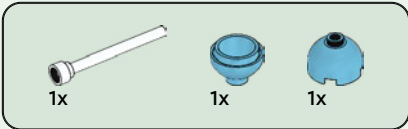

122

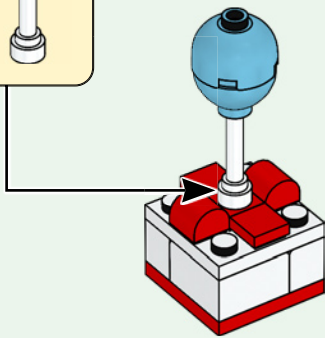
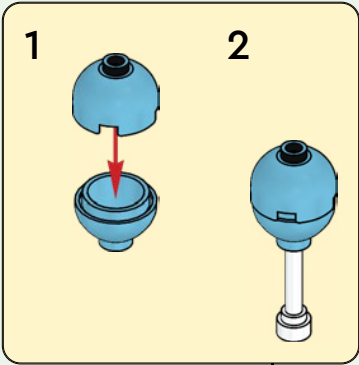

123

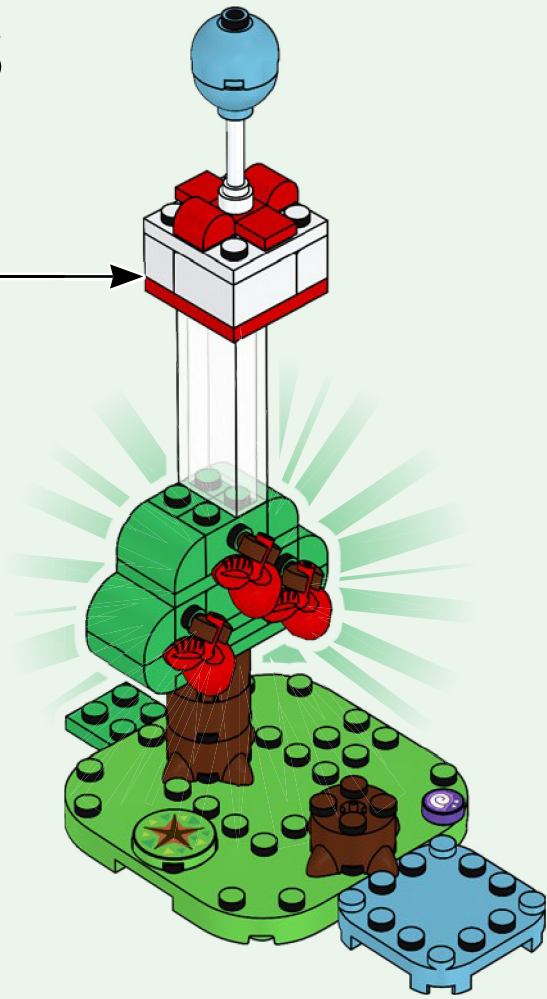

124



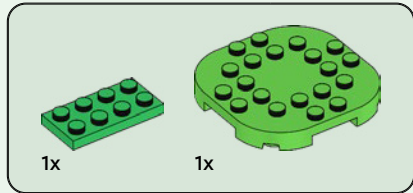

125

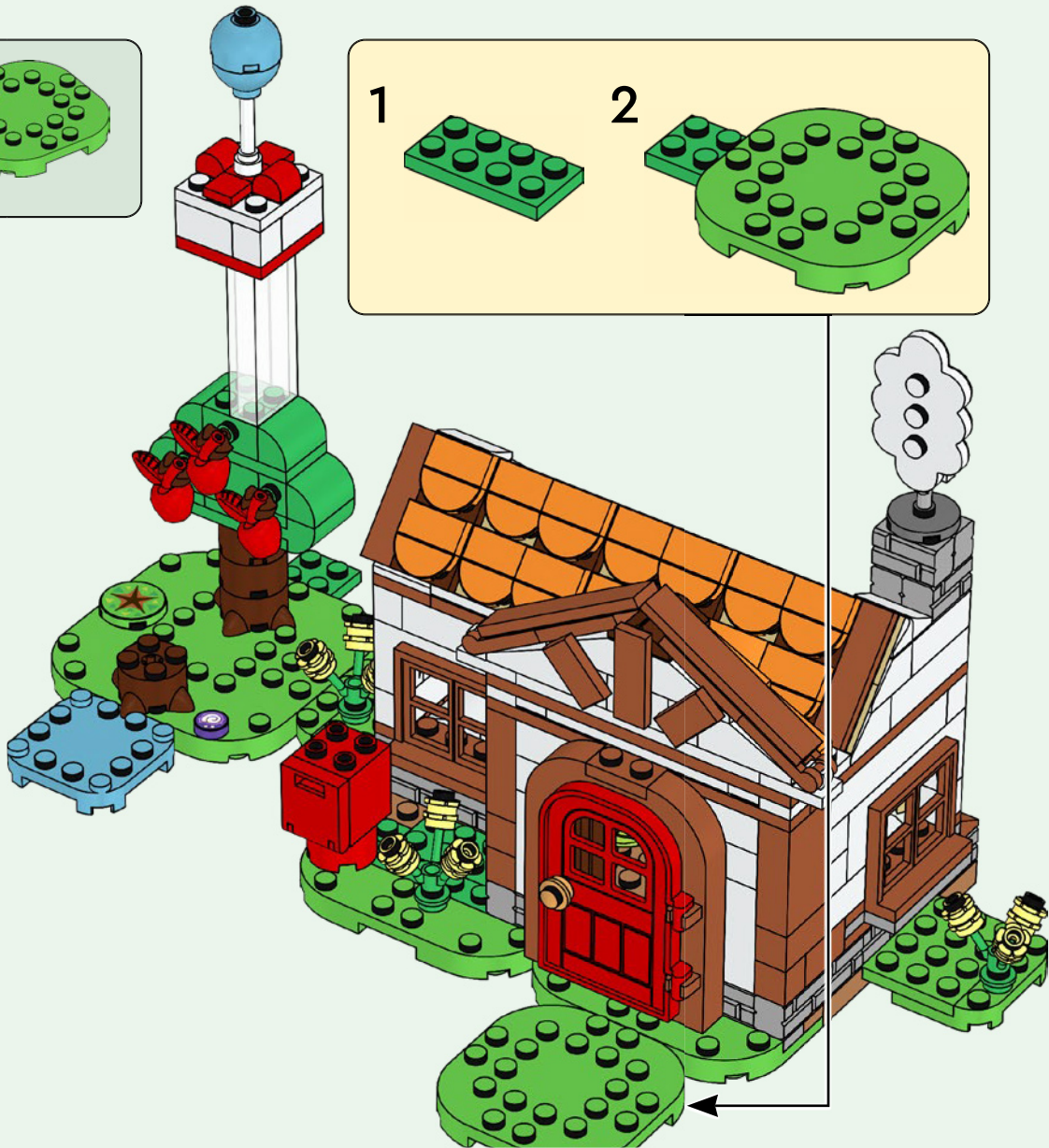
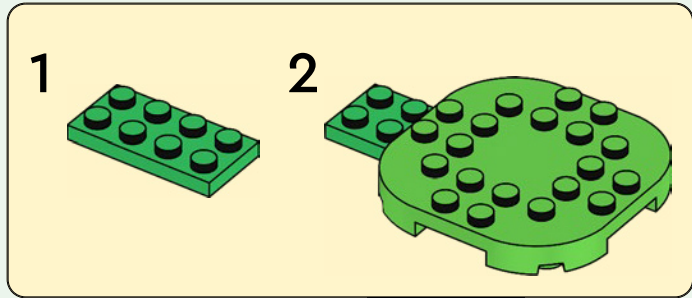



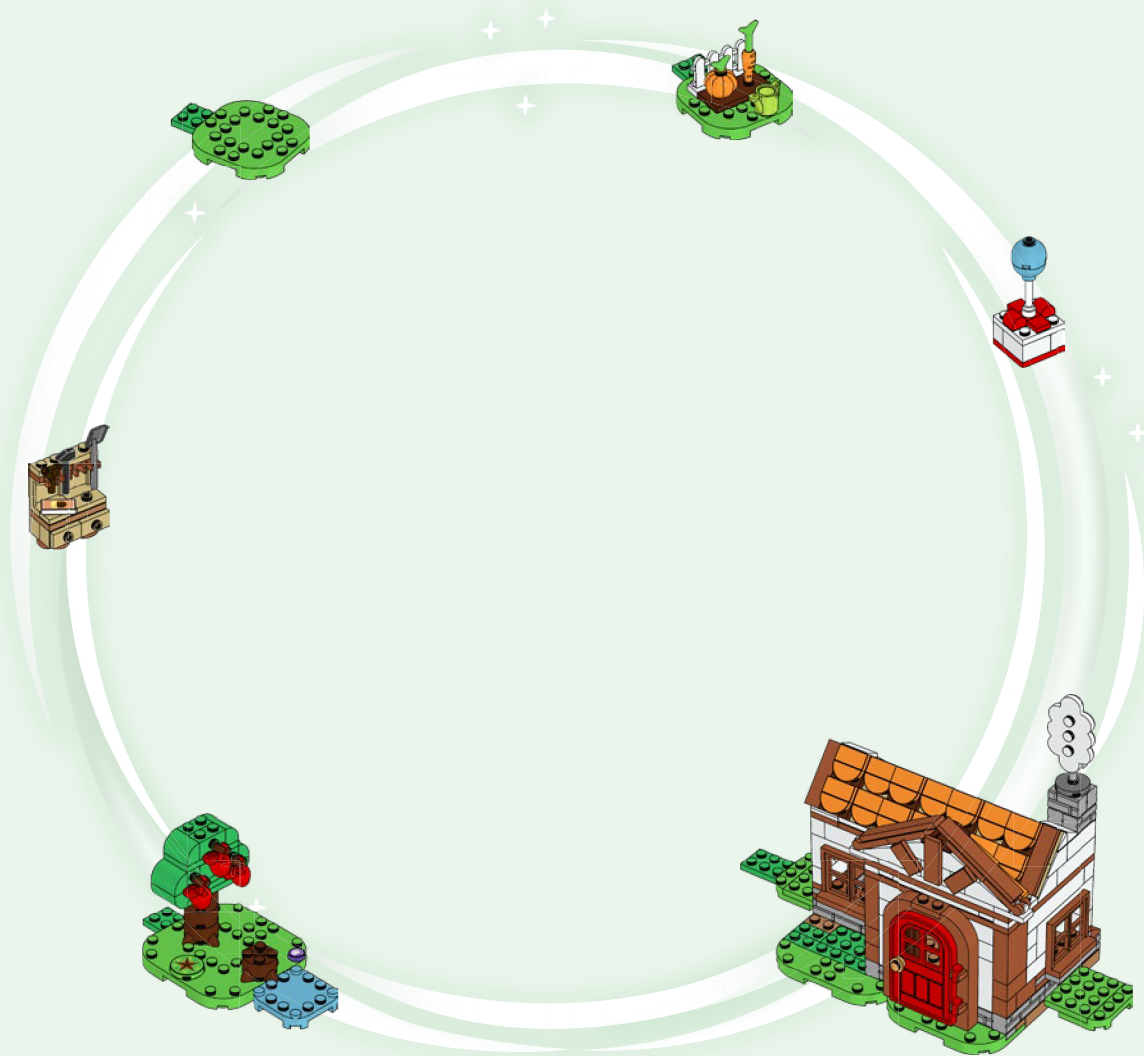





Welcome to Animal Crossing





77046



77047



77048



77049



77050

3x
6074892

2x
6074893

2x
6468832

4x
6253418

2x
6359696

1x
6340118

1x
6468831

1x
6477896

1x
6351327

1x
6251285

1x
6253231

1x
6499105

1x
6284582

2x
4173805

2x
6173925

1x
6267125

1x
6469538

12x
4188771

1x
6424015

4x
6477942

12x
6477975

1x
4650977

1x
6337519

1x
6209692

4x
4537251

2x
6286831

1x
6361353

1x
6484619

1x
6489623

2x
6290541

1x
6365027

1x
6096091

2x
6385485

1x
6122504

2x
6295078

3x
6439053

1x
6359662

1x
6167879

1x
6174229

2x
4504376

2x
6035291

2x
4211166

2x
6468829

1x
6236915

1x
4216695

1x
6262952

1x
6307618

3x
4211186

1x
4211503

4x
4211399

1x
6227897

9x
6000066

1x
4211398

1x
6066097

5x
6314891

2x
4211395

1x
4211425

1x
6115080

1x
4211006

1x
6096990

4x
6251940

18x
6426463

8x
6275877

2x
6301835

1x
6486312

1x
6469559

1x
6469536

1x
6287612

1x
4523159

1x
4624615

1x
6329593

1x
6287854

2x
6218360

2x
6102998

2x
6093494

1x
6445924

2x
6482656

1x
6415996

1x
6132411

1x
6429058

1x
6469904

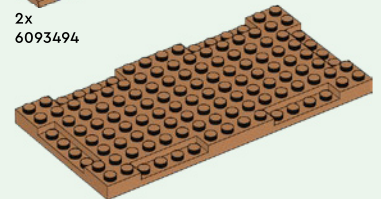

1x
6445924



 [LEGO.com/service](https://www.LEGO.com/service)

YOU COULD
WIN

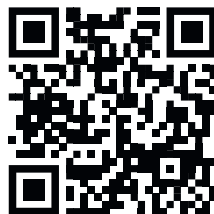

Scan this QR code or go to
LEGO.COM/PRODUCTFEEDBACK and give us
your short feedback about this LEGO® set for a
chance to win a cool LEGO prize.

Terms and Conditions apply*

EN: YOU COULD WIN. Terms and Conditions apply* **DE: Du könntest GEWINNEN.** Es gelten die Teilnahmebedingungen* **FR: Tu pourrais GAGNER.** Des conditions s'appliquent* **IT: Potresti VINCERE tu.** Termini e condizioni sono applicabili* **ES: Puedes GANAR.** Aplican términos y condiciones* **PT: Poderá GANHAR.** Aplicam-se termos e condições* **ZH: 轻松获奖. 条款和条件适用*** **PL: Szansa na WYGRANĄ.** Obowiązują warunki korzystania* **CS: Máte šanci VYHRÁT.** Platí všeobecné smluvní podmínky* **SK: Máte šancu VYHRAŤ.** Platia všeobecné zmluvné podmienky* **HU: TE IS NYERHETSZ.** Felhasználási feltételek érvényesek* **RO: Ai putea CÂȘTIGA.** Se aplică termeni și condiții* **BG: Можете да СПЕЧЕЛИТЕ.** Има определени правила и условия* **LV: Tu vari LAIMĒT.** Ir spēkā noteikumi un nosacījumi.* **ET: Sul on võimalus VÕITA.** Kehtivad tingimused* **LT: Jūs galite LAIMĖTI.** Taikomos sąlygos*

*[LEGO.com/productfeedback-terms](https://www.lego.com/productfeedback-terms)