



Disney

43248



LEGO® Builder



Get excited about our new packaging!

We're switching from plastic to paper-based packaging. That's why you might find a mix of paper and plastic in our boxes!

Nos nouveaux emballages vous emballeront !

Nous passons des emballages en plastique aux emballages à base de papier. C'est pourquoi vous pourriez trouver un mélange de papier et de plastique dans nos boîtes !

¡Te presentamos nuestros nuevos empaques!

Estamos sustituyendo las bolsas de plástico por bolsas con base de papel. ¡Por eso, puedes encontrar una mezcla de papel y de plástico en nuestras cajas!

[LEGO.com/sustainable-packaging](https://www.lego.com/sustainable-packaging)

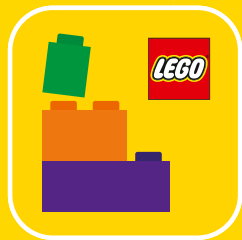

Q LEGO® Builder

BUILDER



Apple and the Apple logo are trademarks of Apple Inc., registered in the U.S. and other countries and regions. App Store is a service mark of Apple Inc. Google Play and the Google Play logo are trademarks of Google LLC. Tencent and the Tencent logo are trademarks of Tencent Inc.

Q LEGO.com/devicecheck

EN Ask parents' permission before going online | DE Eltern um Erlaubnis bitten, bevor du online gehst | FR Demande l'autorisation d'un parent avant d'aller en ligne | IT Chiedi il permesso ai tuoi genitori prima di andare online | ES Pídeles permiso a tus papás antes de conectarte a Internet | PT Pede autorização aos pais antes de acederes online | ZH 上网前应先征得父母的同意 | PL Poproś rodziców o zgodę, zanim wejdiesz do Internetu | CS Než půjdeš na internet, požádej rodiče o svolení | SK Skôr než pôjdeš na internet, vypýtaj si povolenie od rodičov | HU Kérj szülői engedélyt, mielőtt online csatlakoznál! | RO Cere permisiunea părinților înainte de a te conecta online | BG Поискайте разрешение от родител, преди да влезете онлайн | LV Pirms došanās tiešsaistē palūdz atļauju vecākiem | ET Enne Interneti kasutamist küsi vanematelt luba | LT Prieš prisijungdami prie interneto, atsiklauskite tėvų



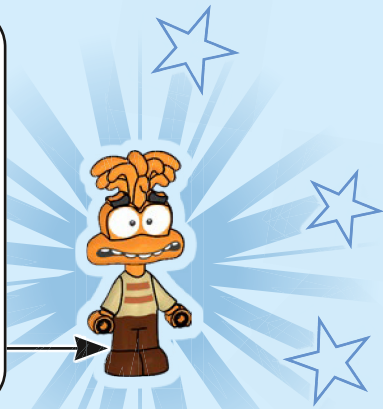
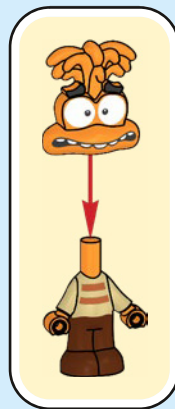
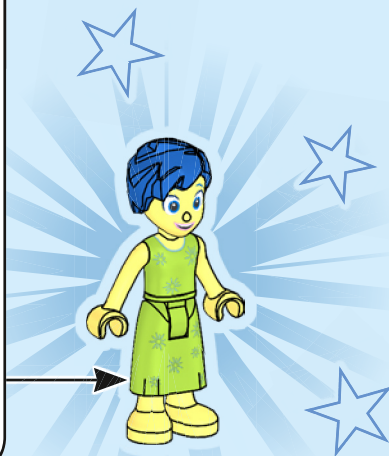
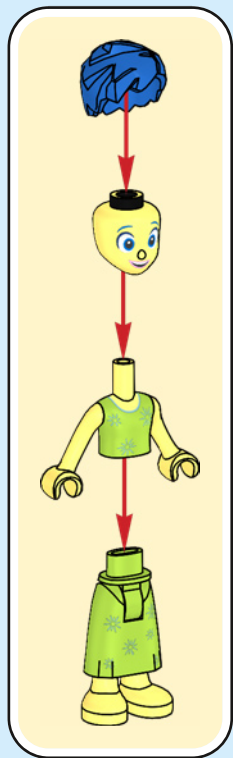

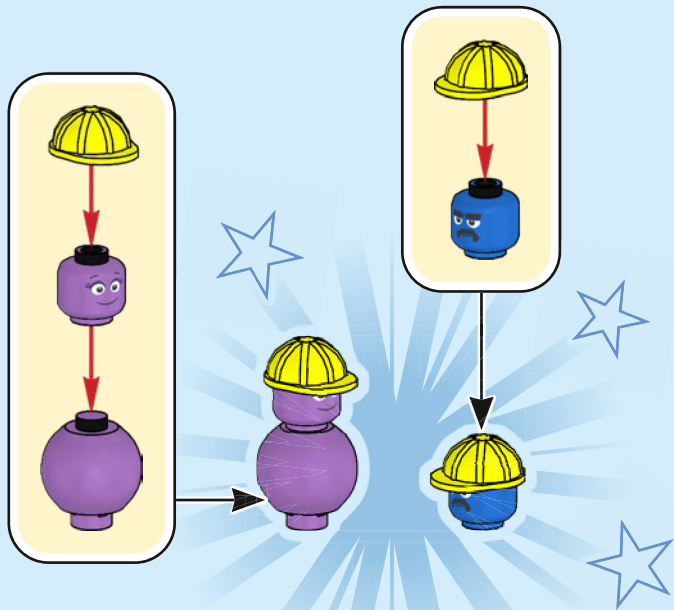

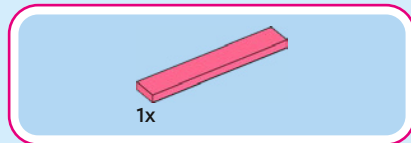
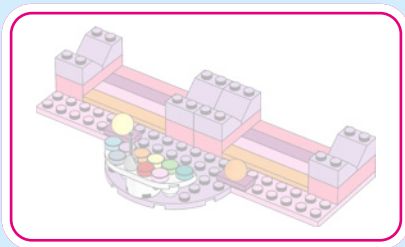

2

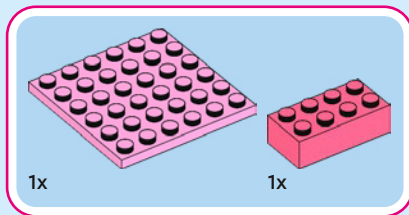

1

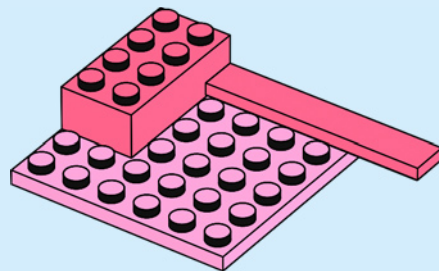
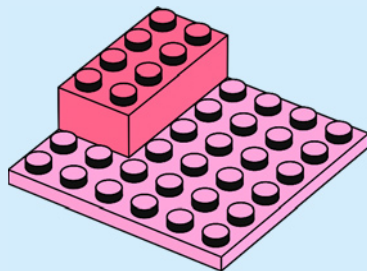

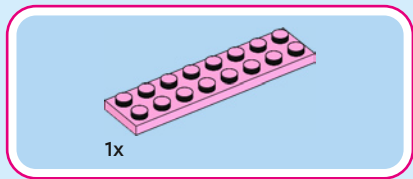

3

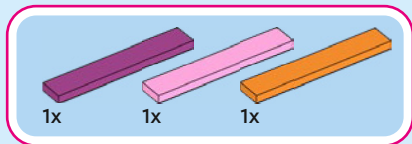
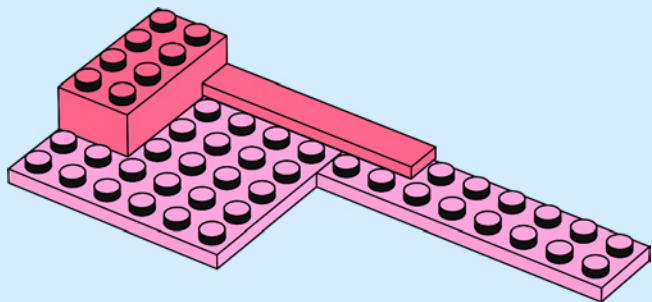

4

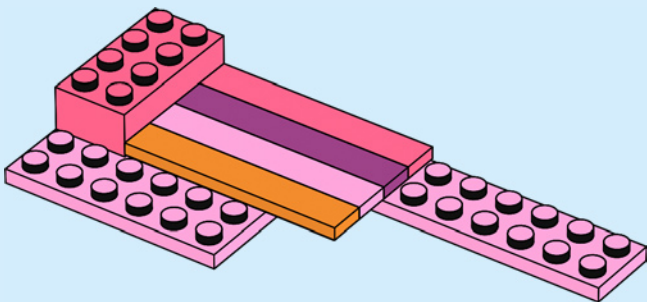

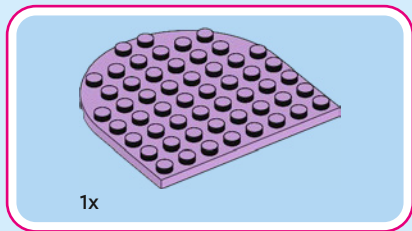

5

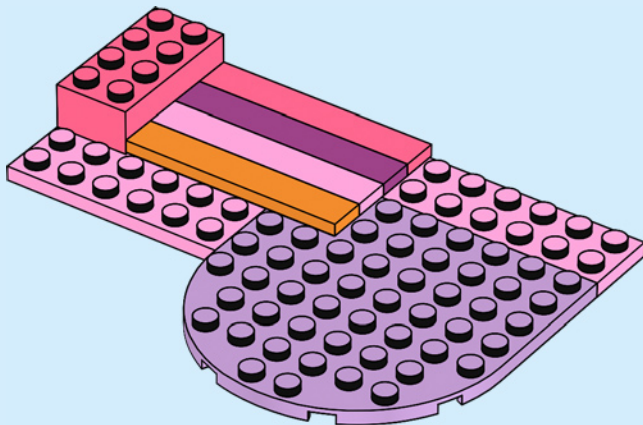

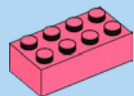

2x

6

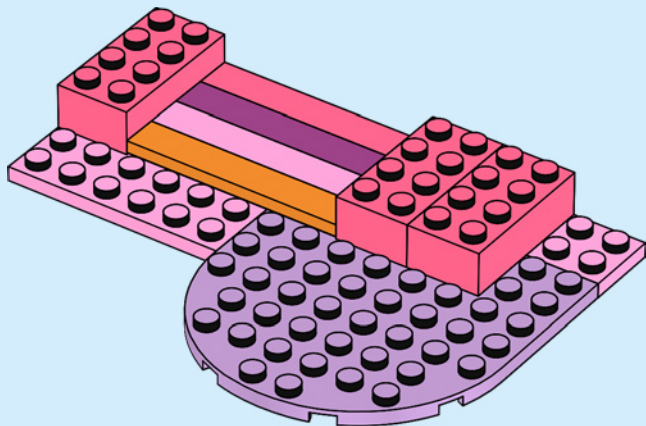

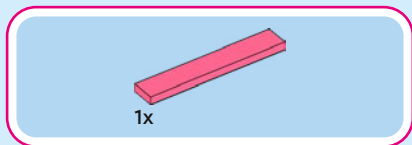

7

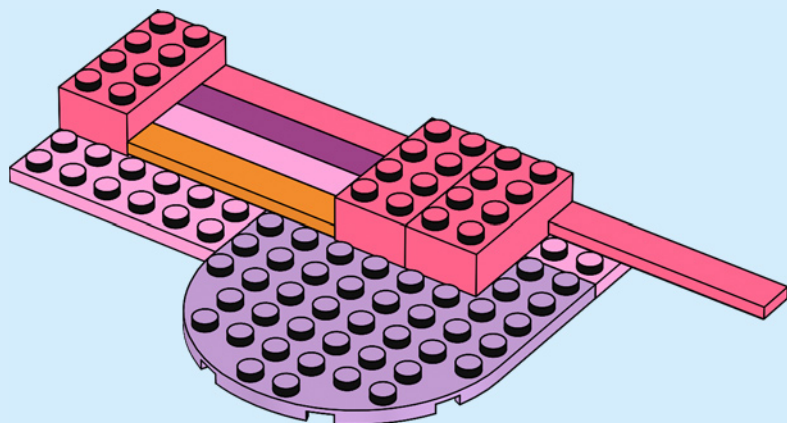

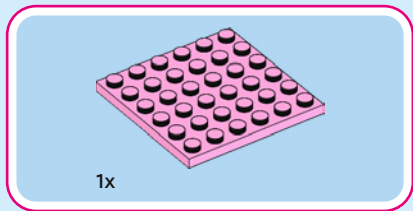

8

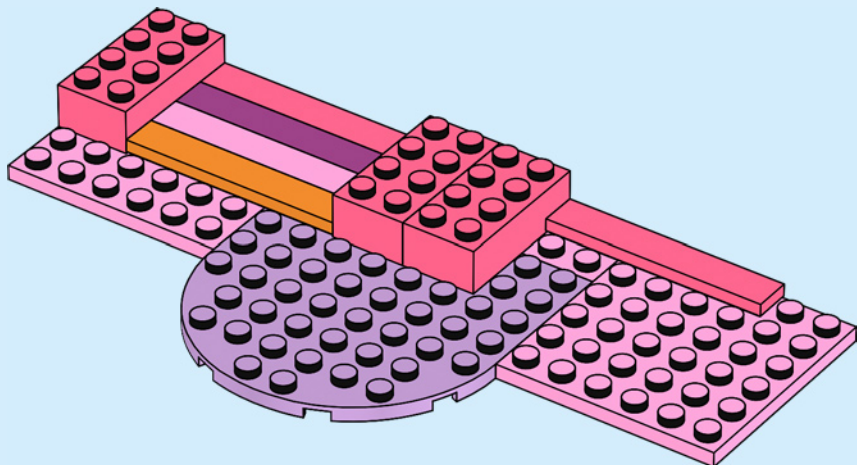

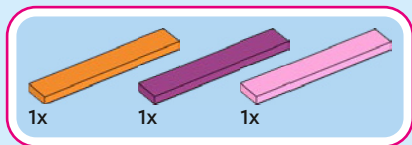

9

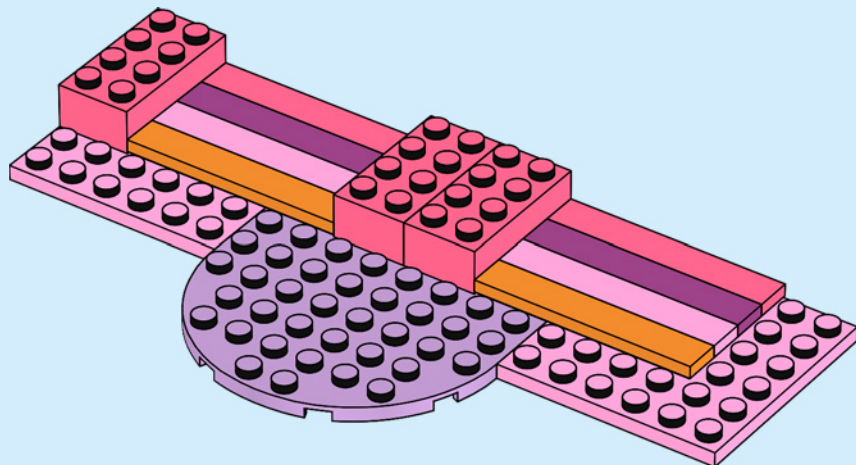

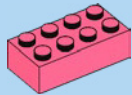

1x

10

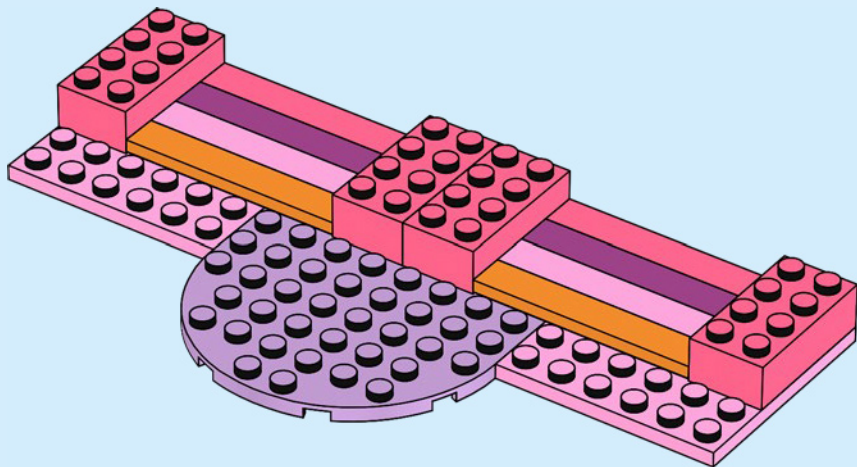



8x

11

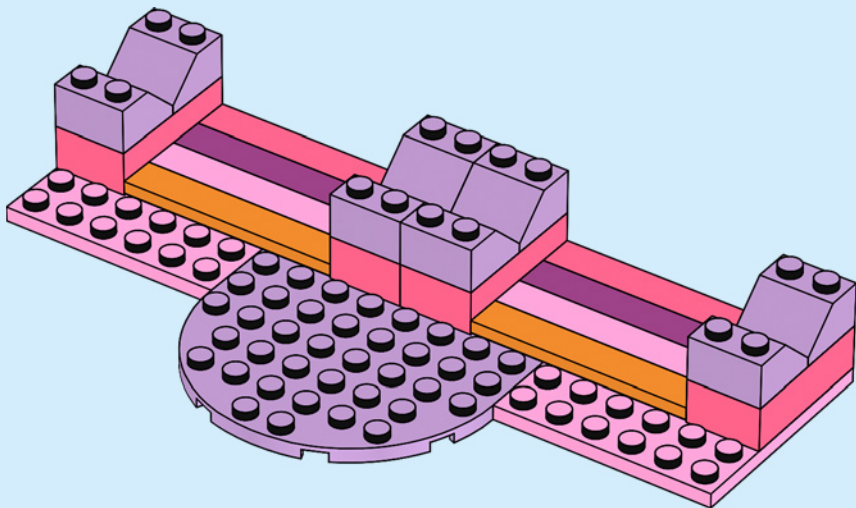



2x

12

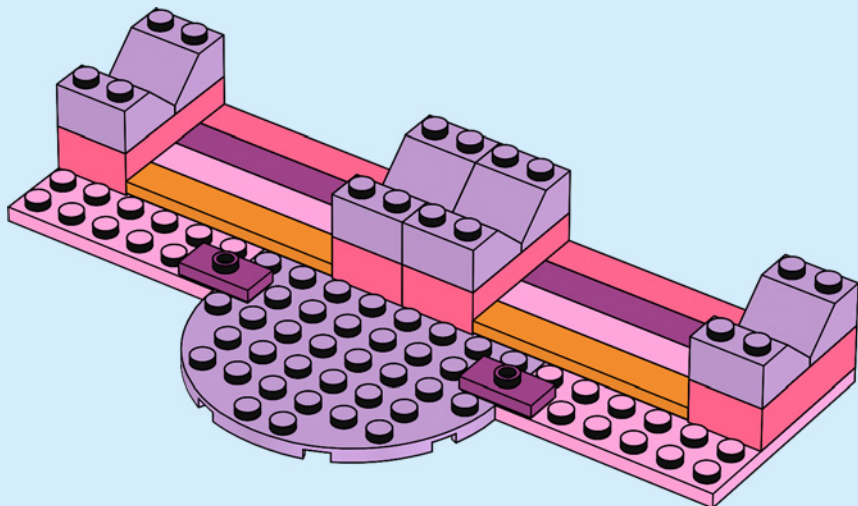

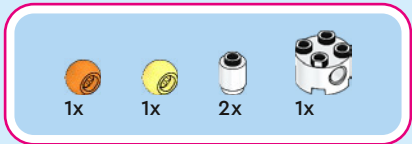

13

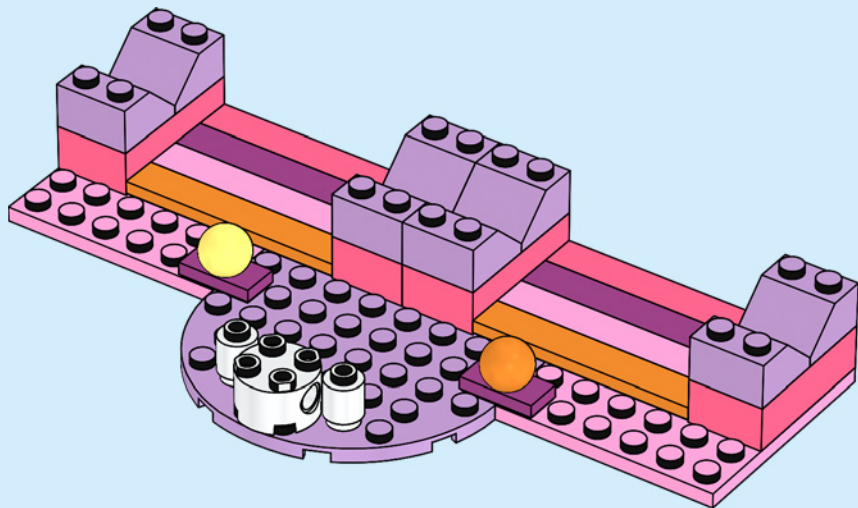

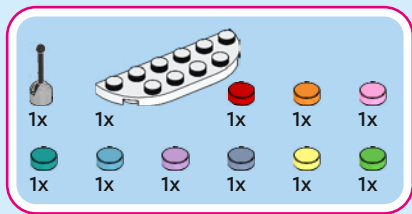

14

1



2



3



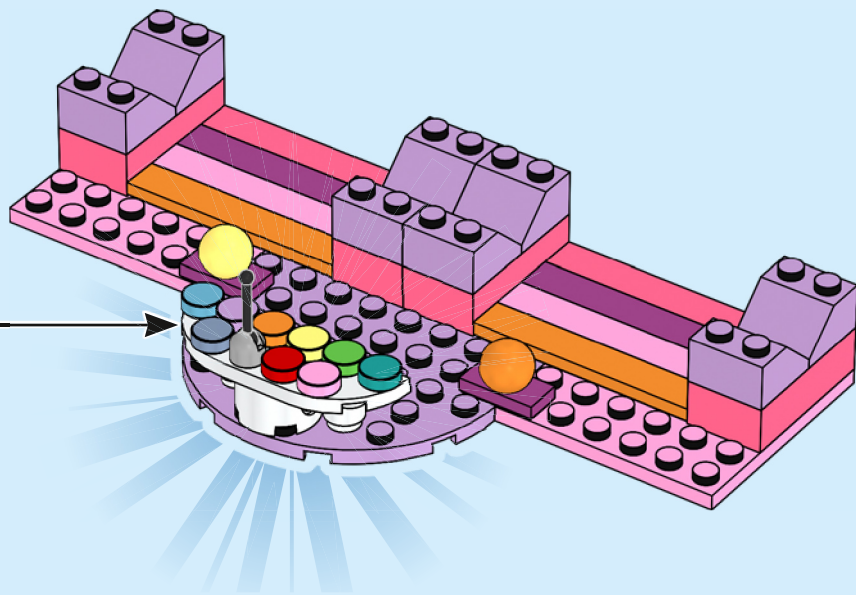



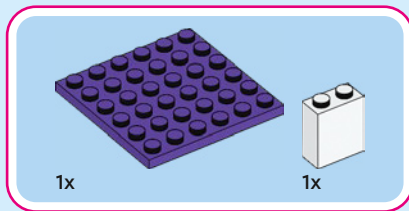
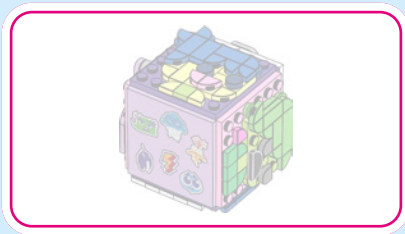

1

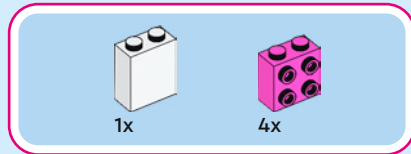
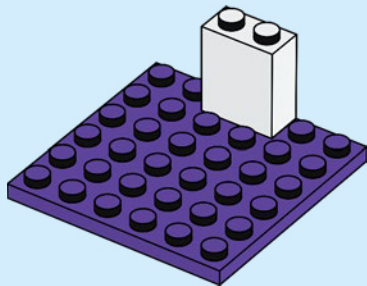

2

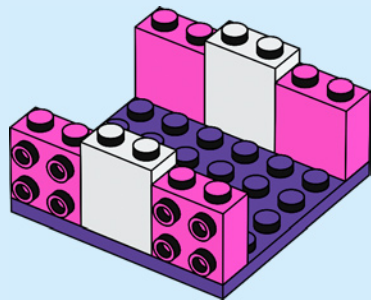



4x

3

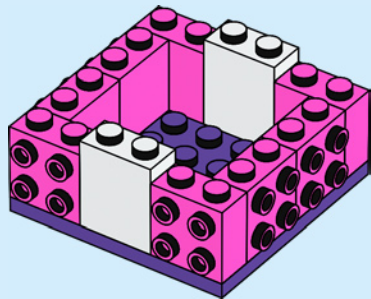

4x



2x

4

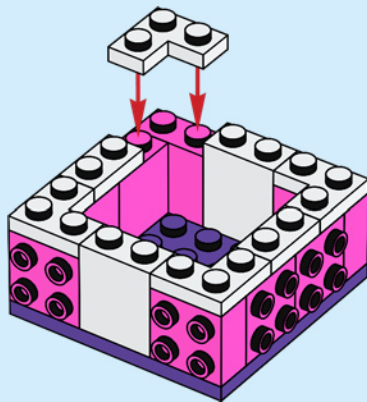

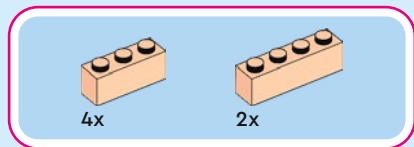

5

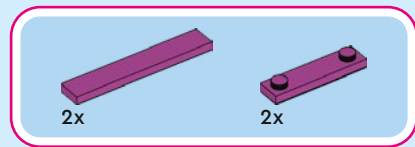
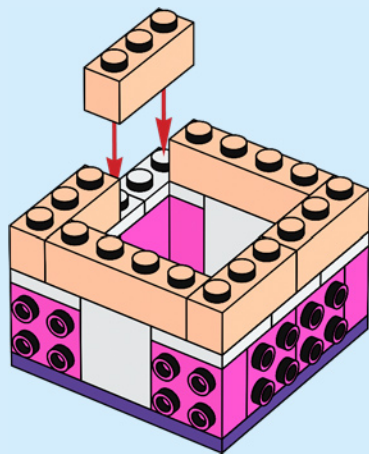

6

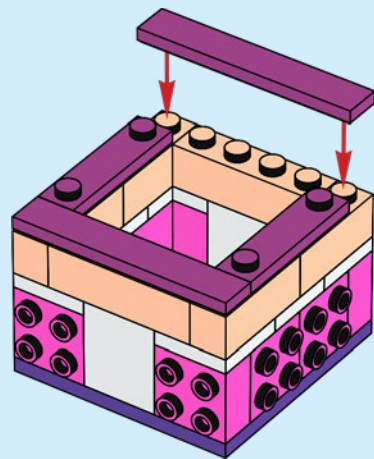



6x

7

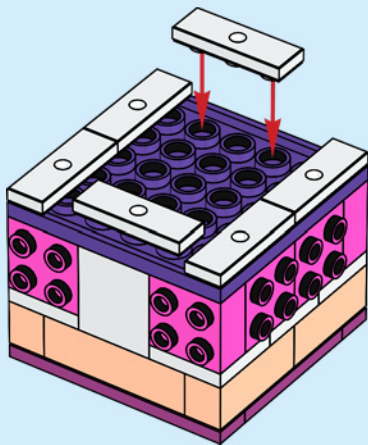



6x

8

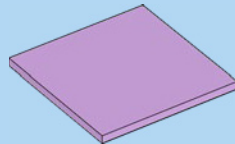
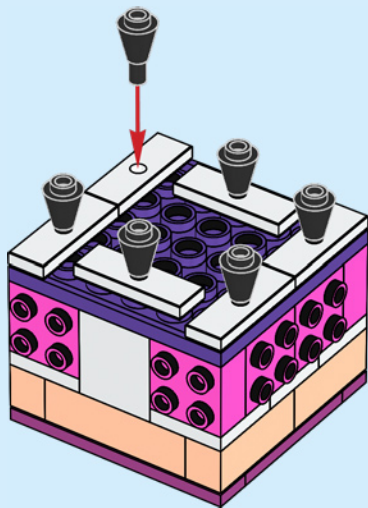

1x

9

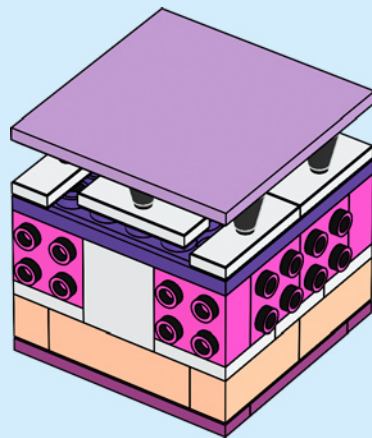

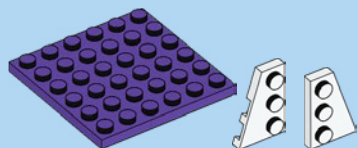

1x

1x

1x

10

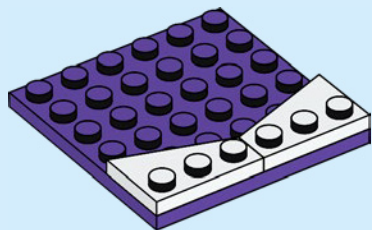

2x



1x



1x

11

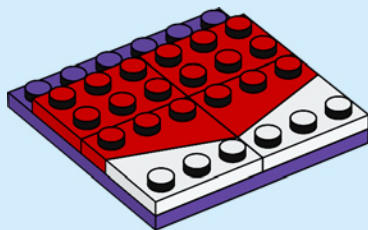



6x

12

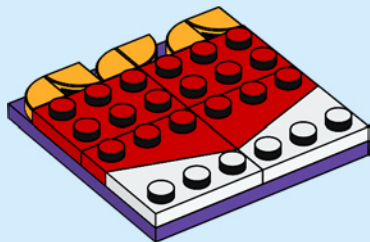

1x



1x



2x



2x

13

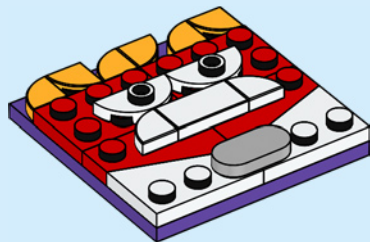



2x

14

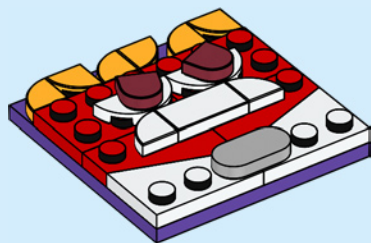

15

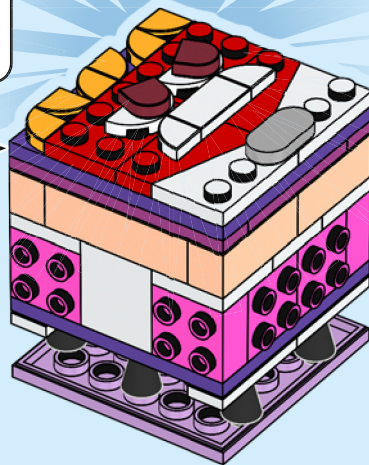

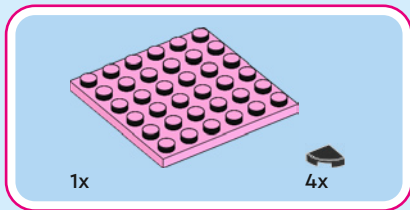
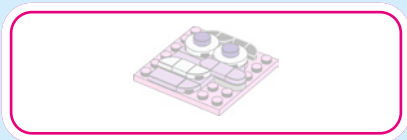

16

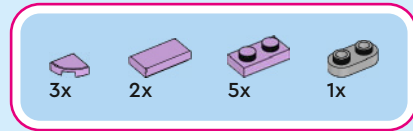
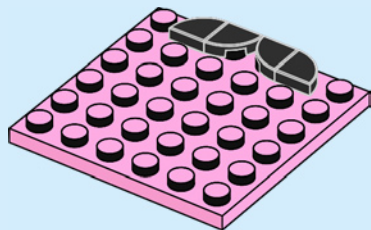

17

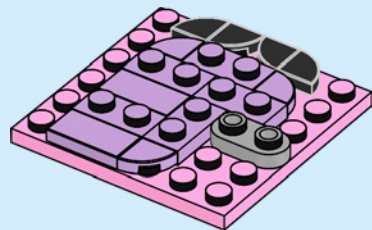

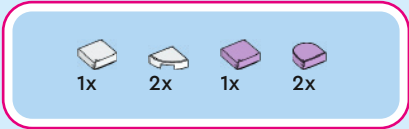

18

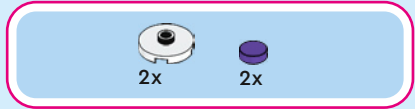
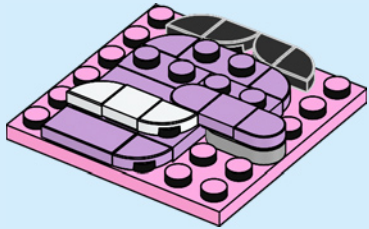

19

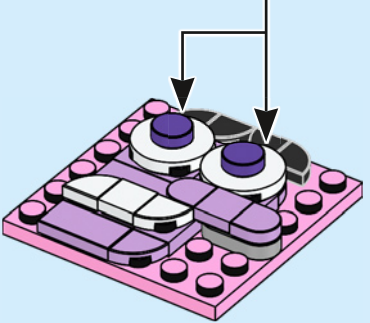
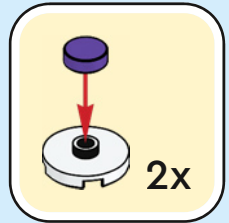

20

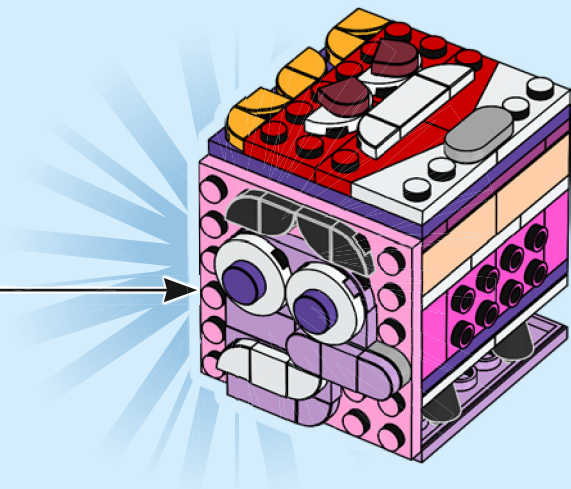

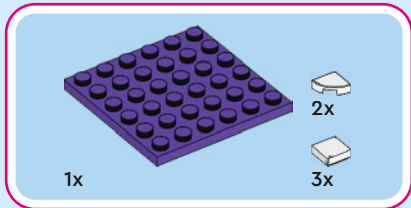

21

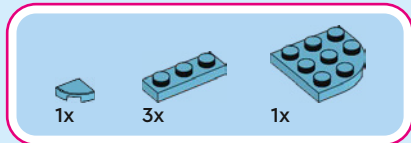
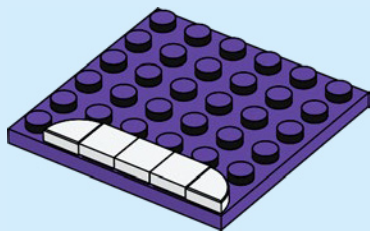

22

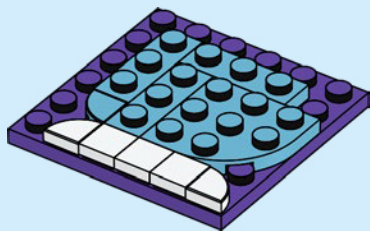



9x

23

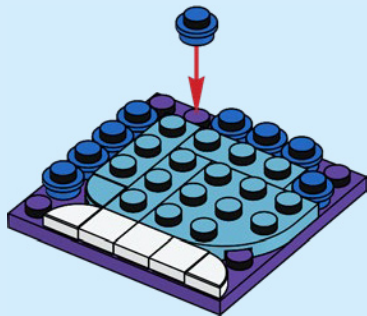

2x



2x

24

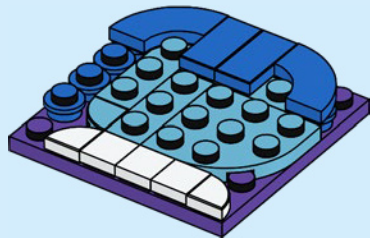



1x



1x



5x

25

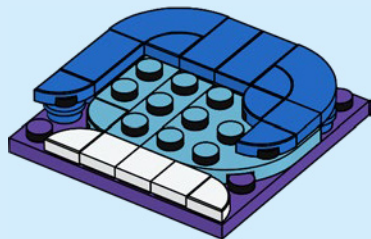

2x

26

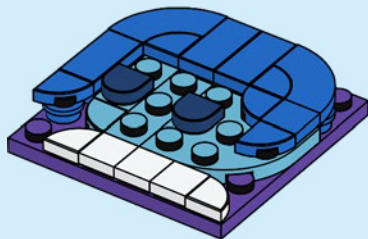

27

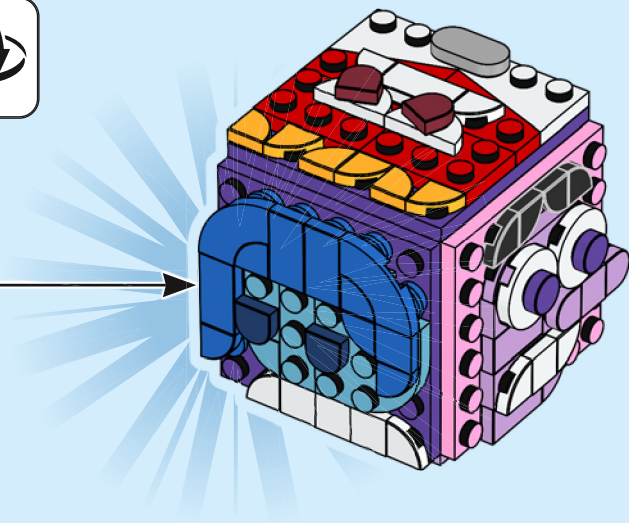
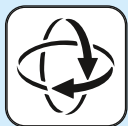

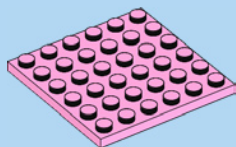

1x



3x



1x

28

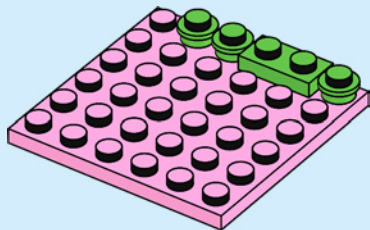

1x



3x



1x



1x



29

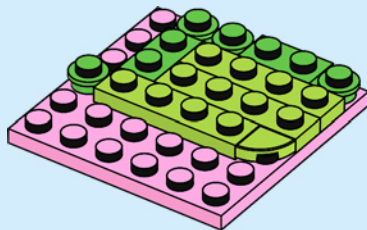

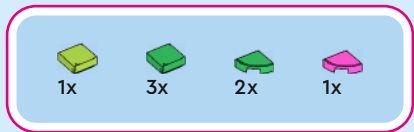

30

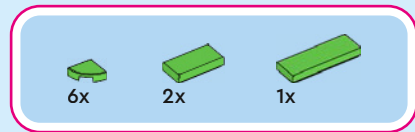
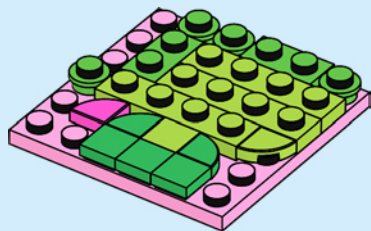

31

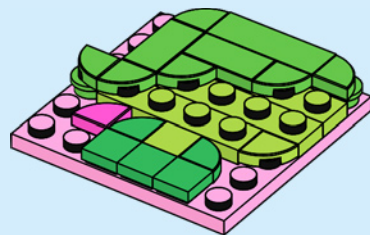



2x



1x

32

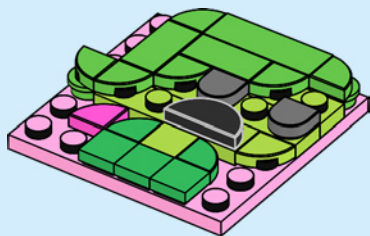

33

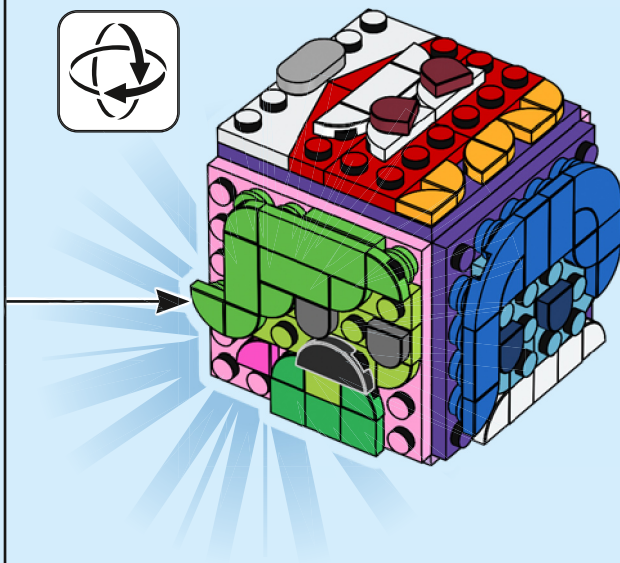

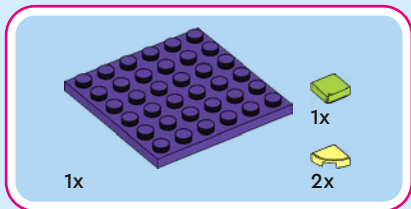
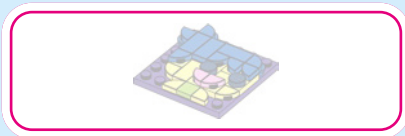

34

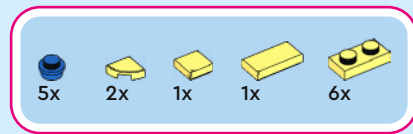
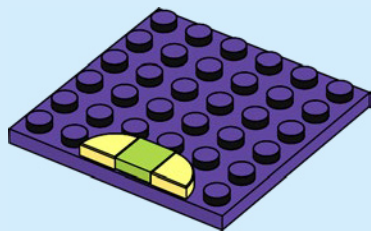

35

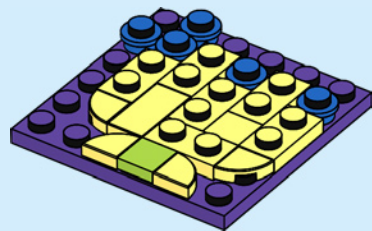



3x



7x

36

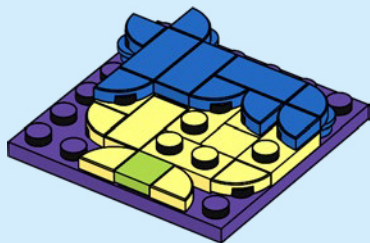

2x



2x

37

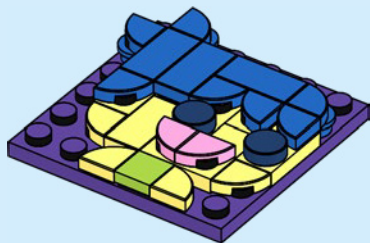

38

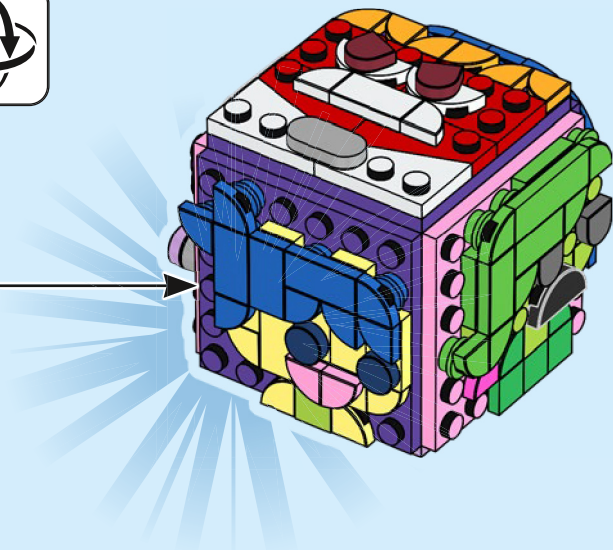

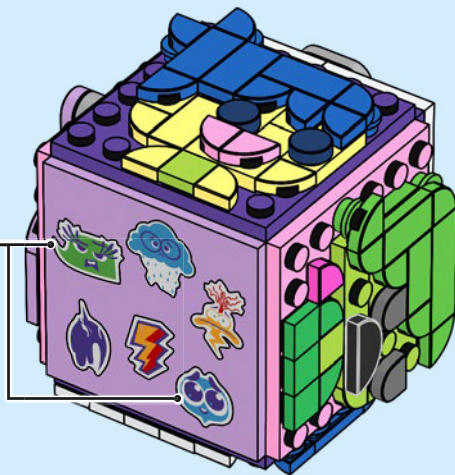

40

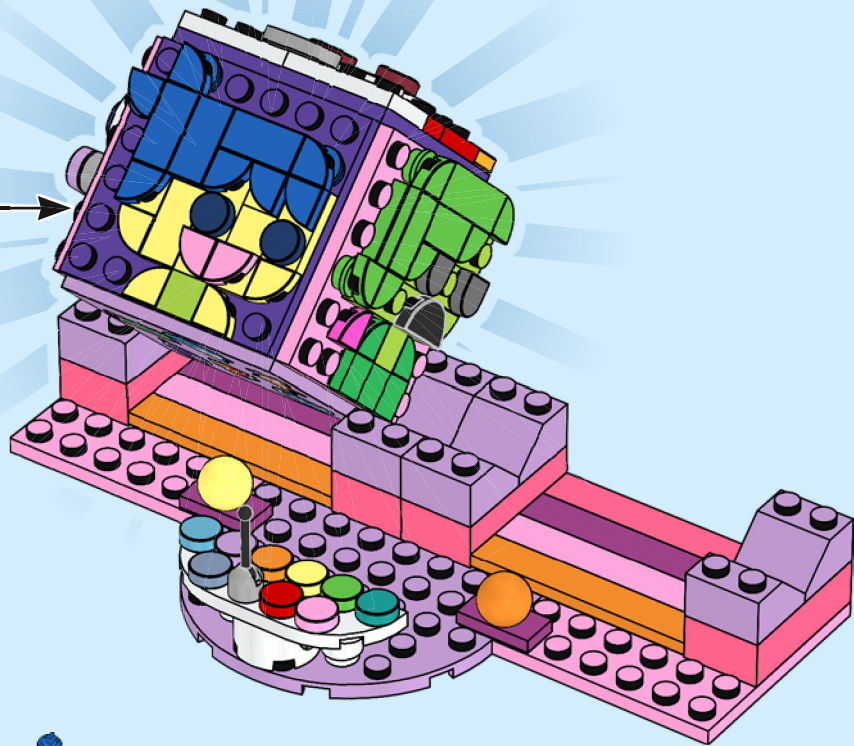



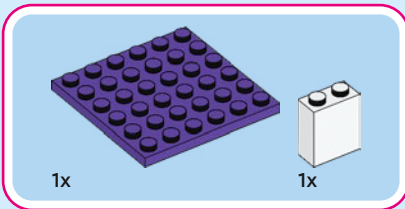

1

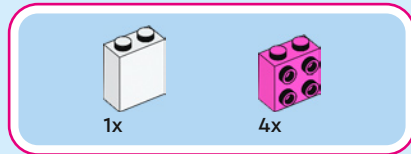
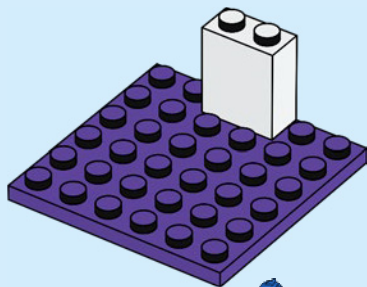

2

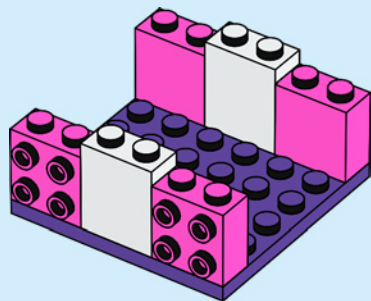



4x

3

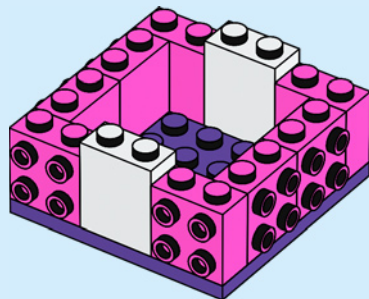



4x



2x

4

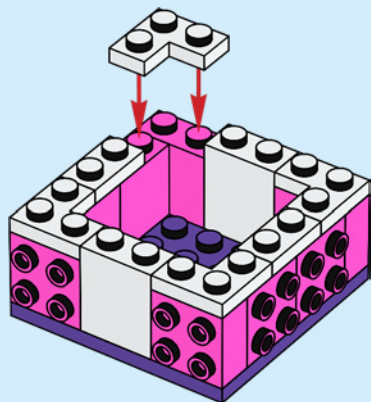

4x

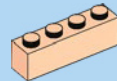

2x

5

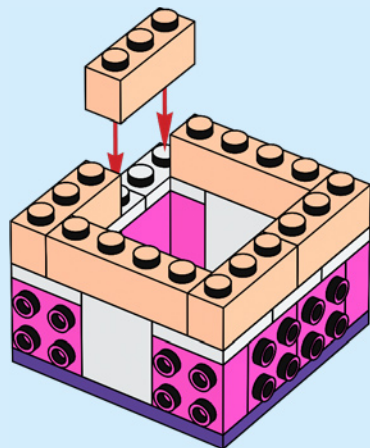

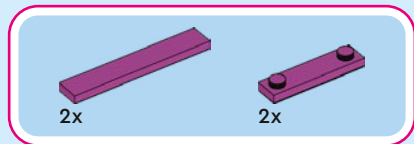

6

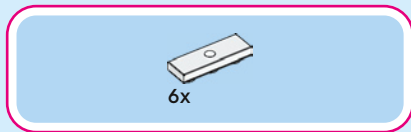
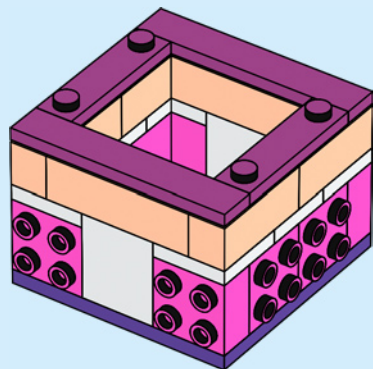

7

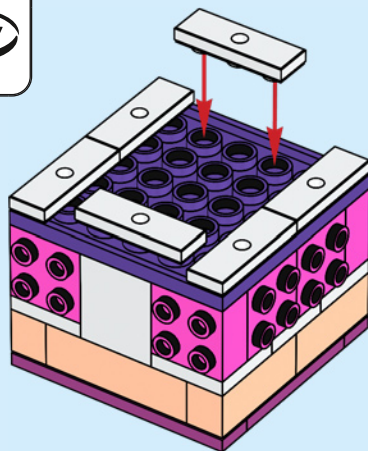



6x

8

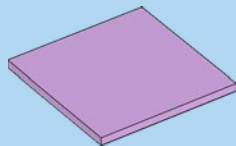
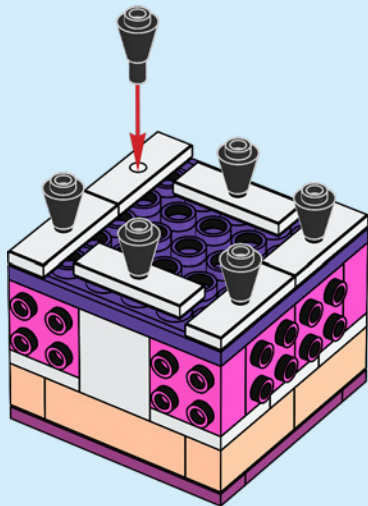

1x

9

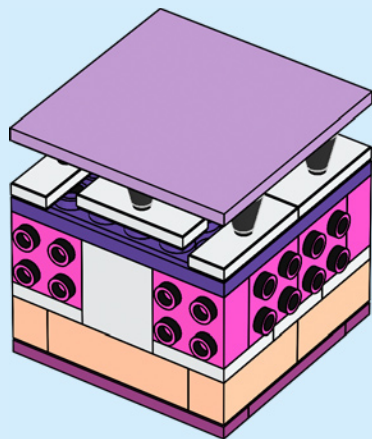

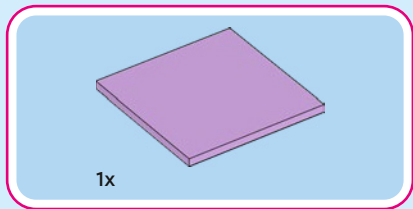

10

1

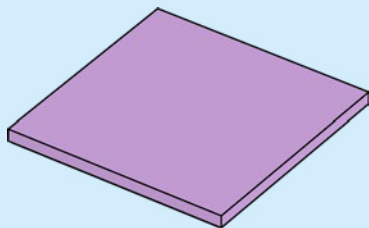

2

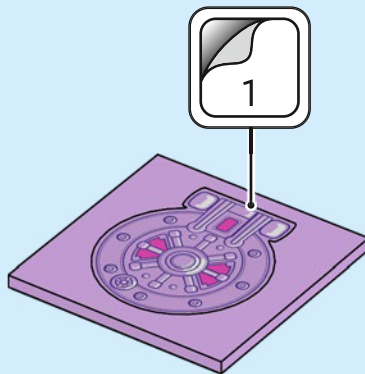

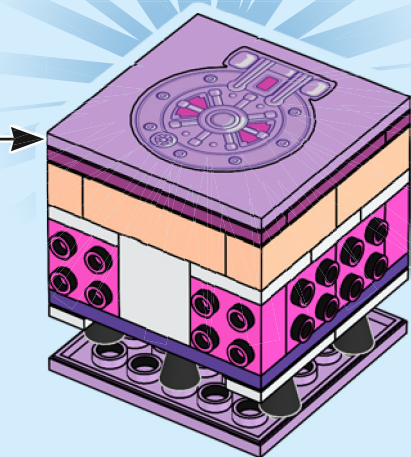

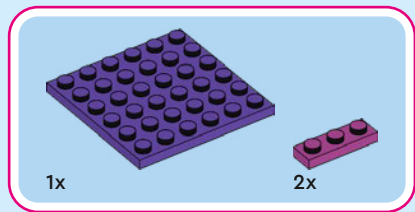

11

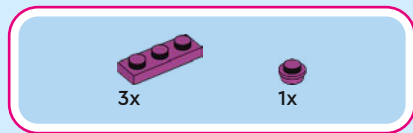
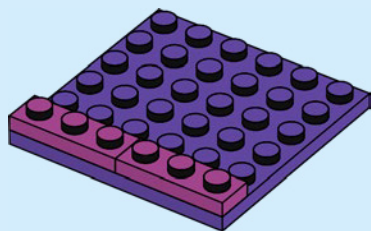

12

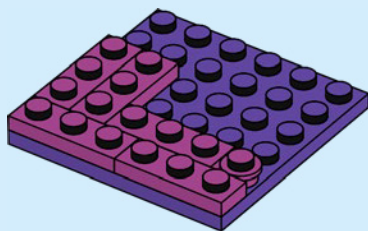

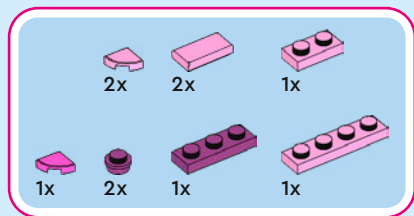

13

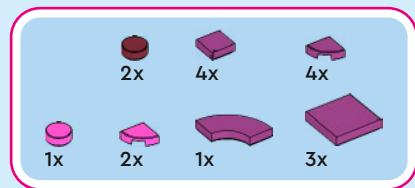
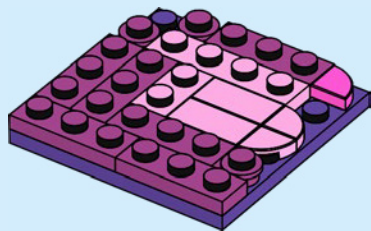

14

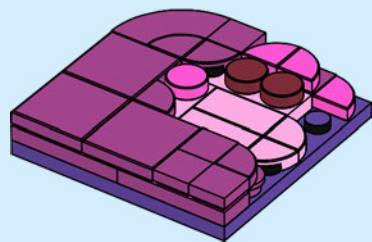

15

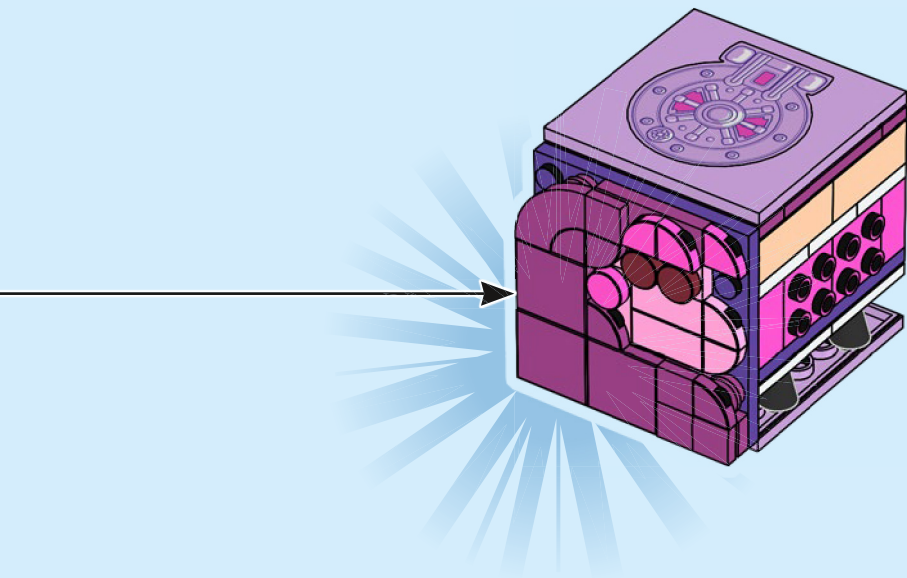

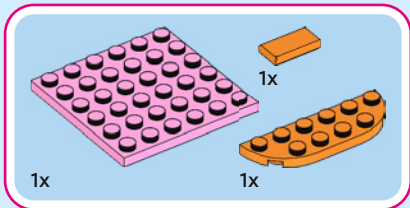
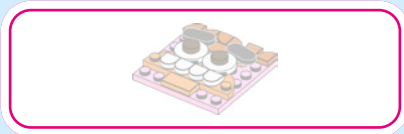

16

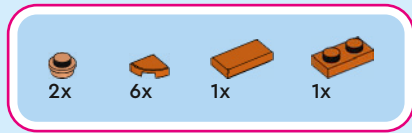
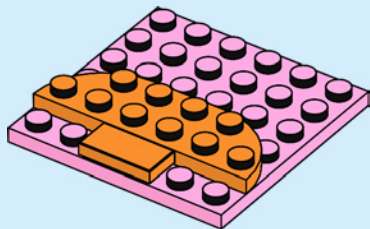

17

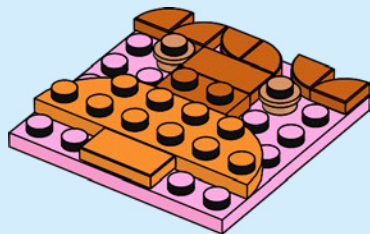



2x



4x

18

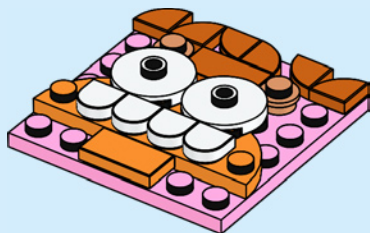

2x



2x

19

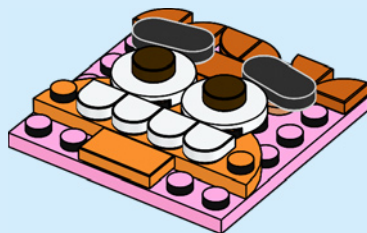

20

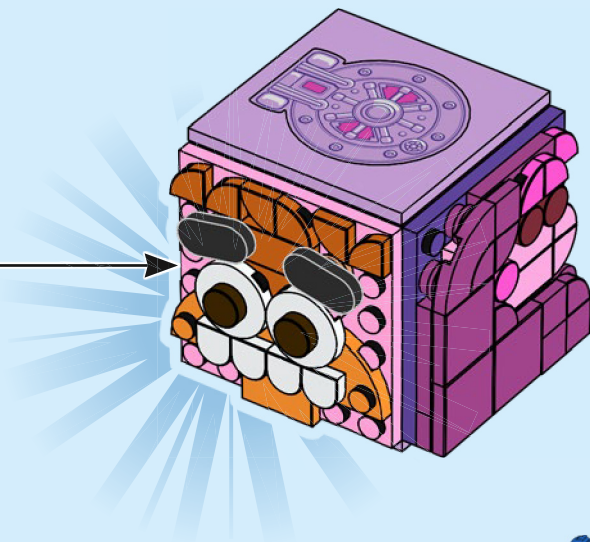

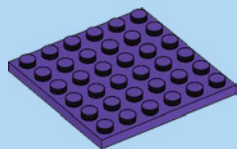
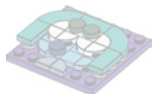

1x



2x

21

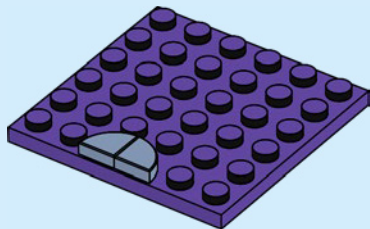

10x



2x



1x



3x



1x

22

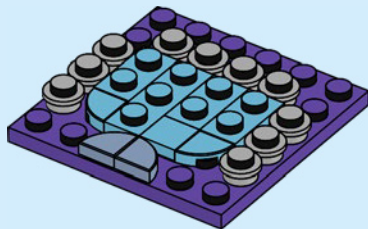



3x



2x

23

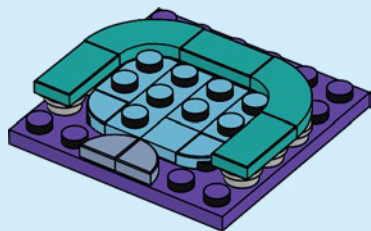

1x



6x



1x

24

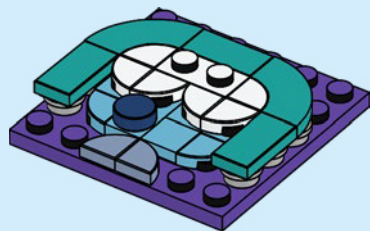

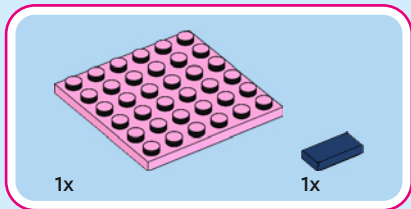

27

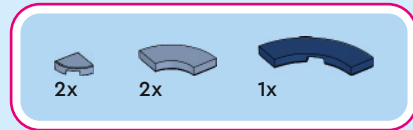
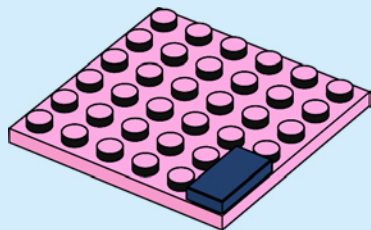

28

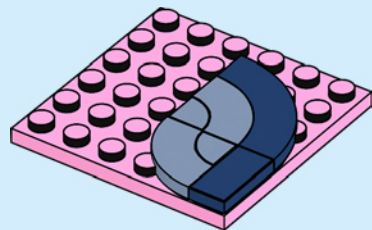



2x



1x



2x



3x

29

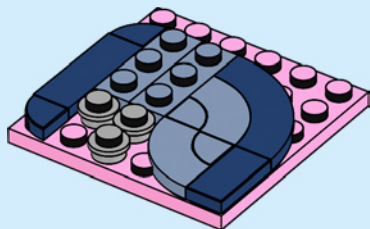

2x



1x



2x



2x



2x

30

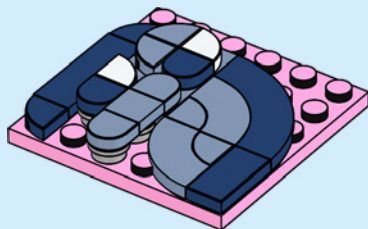

31

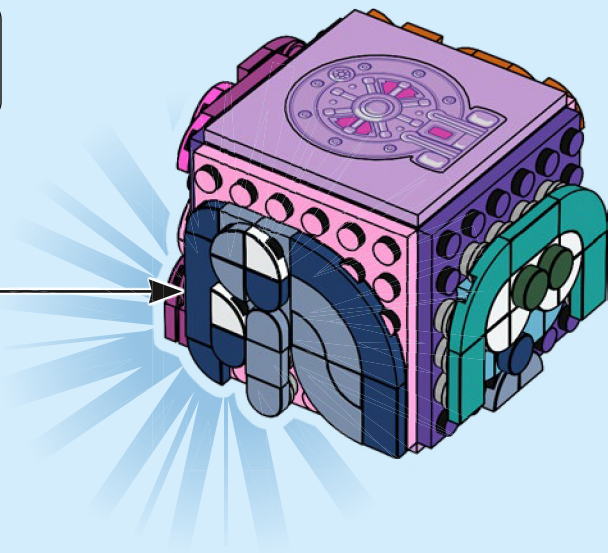

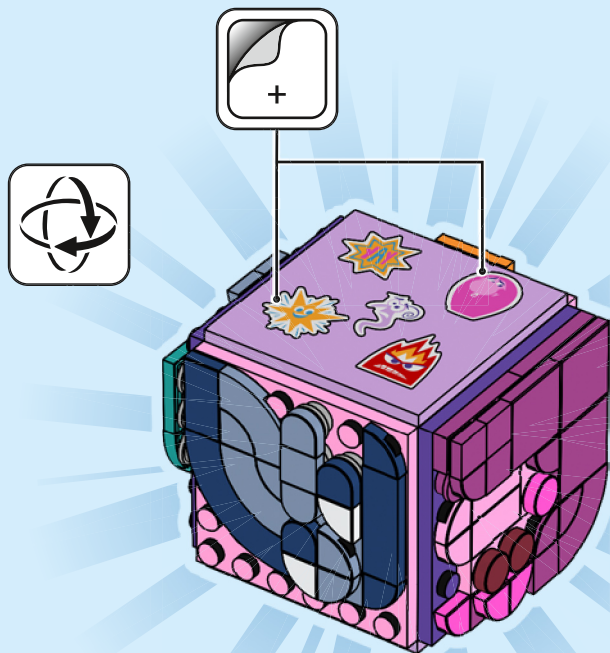

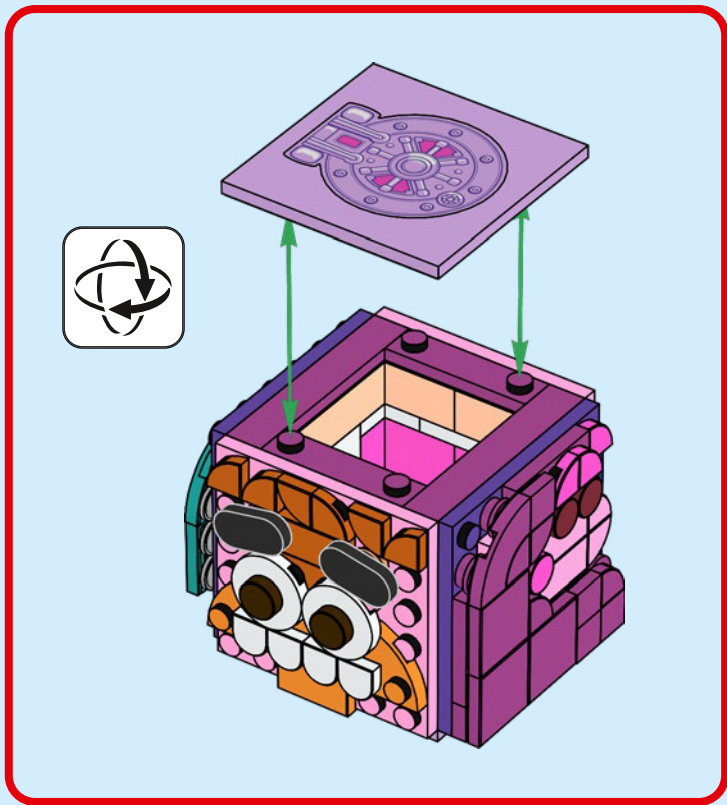

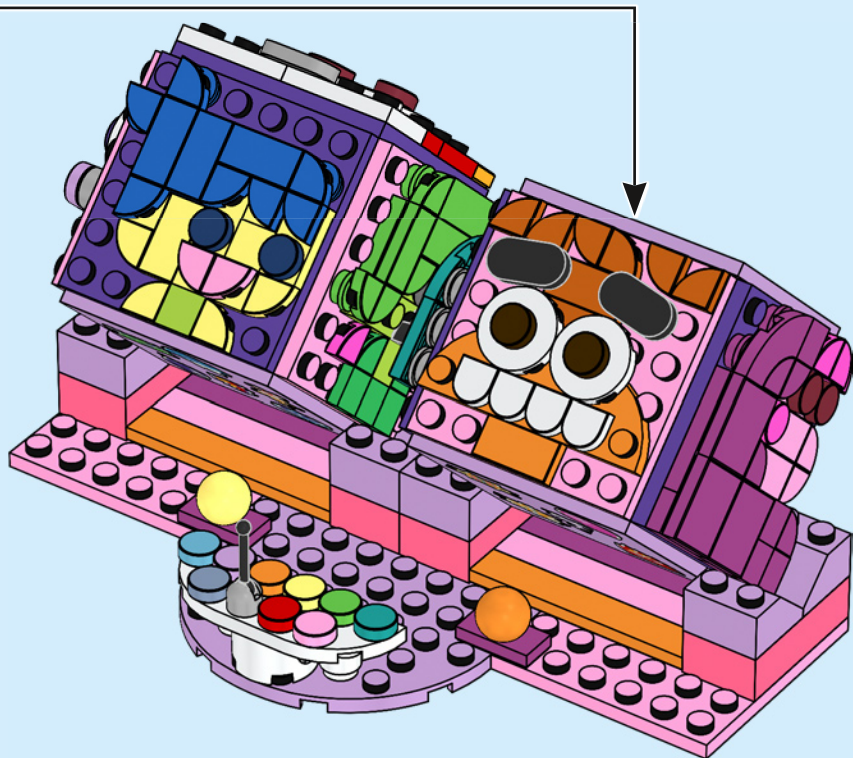





Disney



Disney
Stitch

43249

Disney Pixar
**INSIDE
OUT 2**

43248



Disney
ENCANTO





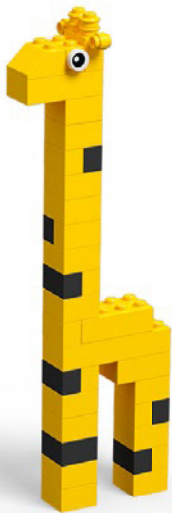
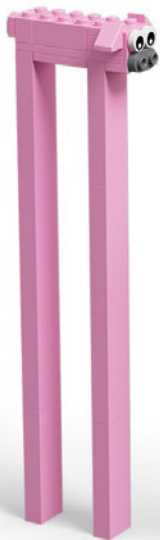

































43237





Rebuild
the
world™



 2x 306201	 5x 302301	 14x 614123	 2x 6150607	 1x 4188771	 3x 6248970	 6x 6400305	 2x 6284585
 4x 6250591	 1x 306901	 1x 6476333	 3x 4558593	 1x 6301806	 4x 6099364	 1x 6138232	 2x 6322997
 14x 6172366	 8x 242001	 12x 6302961	 1x 6353793	 2x 4650690	 4x 6199889	 2x 6142245	 6x 6214457
 4x 307001	 12x 6223491	 1x 4206330	 4x 6109808	 1x 6311437	 2x 6101073	 2x 6480465	 1x 6487389
 2x 6462354	 1x 6147792	 6x 306923	 6x 6275873	 3x 6213779	 1x 6177824	 3x 6284584	 1x 4221775
 1x 4179874	 2x 6391270	 2x 6194724	 2x 6195258	 2x 6213876	 3x 6249234	 4x 6444941	 13x 4211525
 1x 4179875	 1x 6284574	 1x 6486300	 2x 6343326	 1x 6211875	 6x 6022048	 2x 6199890	 1x 6412816
 1x 6218899	 1x 4180533	 12x 6056234	 1x 6318735	 2x 4537251	 4x 6249090	 1x 4528488	 1x 6248890
 4x 6093053	 1x 4180504	 4x 6172383	 1x 6284582	 1x 6486378	 6x 6102821	 1x 6132566	 1x 6322821
 4x 4113261	 2x 302121	 1x 6420852	 1x 6307452	 3x 4187743	 1x 6322842	 1x 6446696	 4x 6240462
 4x 4113261	 2x 302121	 2x 6439515	 1x 6476330	 1x 6486378	 2x 6429608	 1x 6397157	 2x 6362252



16x
6132426



1x
6284587



4x
6240463



1x
4654128



2x
4580010



1x
6002148



2x
6403189

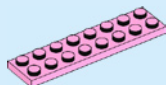

1x
6252555

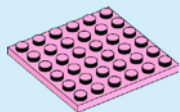

6x
6358030



1x
6343806



1x
6458522



1x
6476334



4x
6228969



1x
6275877



6x
6201647



1x
6061201



1x
6486319



2x
6476247



7x
6426669



8x
6357794



4x
6378419



2x
6322813



1x
6322819



3x
6150307



1x
4655243



3x
6097419



4x
6119107



1x
6264993



1x
6476332



1x
6486415



1x
6466720



1x
6469086



6x
6492073



2x
6399998



4x
6422921

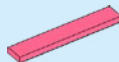

2x
6425367



1x
6322820



2x
6329119



3x
6240465



1x
6211403



5x
6099190



2x
6345796



8x
6172518

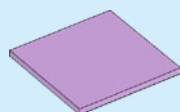

3x
6270156

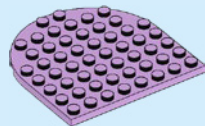

1x
6273856

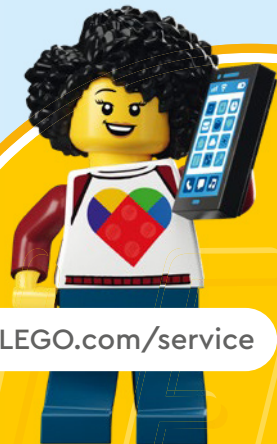

 [LEGO.com/service](https://www.LEGO.com/service)

YOU COULD **WIN**



Scan this QR code or go to **LEGO.COM/PRODUCTFEEDBACK** and give us your short feedback about this LEGO® set for a chance to win a cool LEGO prize.

Terms and Conditions apply*

EN: YOU COULD WIN. Terms and Conditions apply* **DE: Du könntest GEWINNEN.** Es gelten die Teilnahmebedingungen* **FR: Tu pourrais GAGNER.** Des conditions s'appliquent* **IT: Potresti VINCERE tu.** Termini e condizioni sono applicabili* **ES: Puedes GANAR.** Aplican términos y condiciones* **PT: Poderá GANHAR.** Aplicam-se termos e condições* **ZH: 轻松获奖. 条款和条件适用*** **PL: Szansa na WYGRANĄ.** Obowiązują warunki korzystania* **CS: Máte šanci VYHRÁT.** Platí všeobecné smluvní podmínky* **SK: Máte šancu VYHRAŤ.** Platia všeobecné zmluvné podmienky* **HU: TE IS NYERHETSZ.** Felhasználási feltételek érvényesek* **RO: Ai putea CÂȘTIGA.** Se aplică termenii și condiții* **BG: Можете да СПЕЧЕЛИТЕ.** Има определени правила и условия* **LV: Tu vari LAIMĒT.** Ir spēkā noteikumi un nosacījumi.* **ET: Sul on võimalus VÕITA.** Kehtivad tingimused* **LT: Jūs galite LAIMĖTI.** Taikomos sąlygos*

*[LEGO.com/productfeedback-terms](https://www.lego.com/productfeedback-terms)