

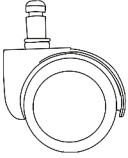

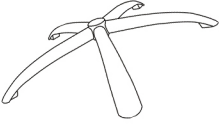

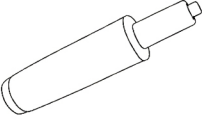

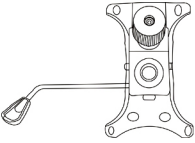
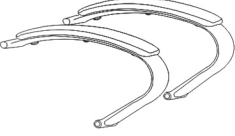
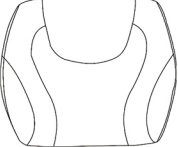
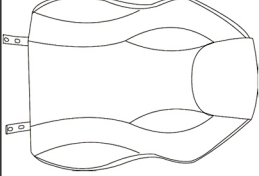

ASSEMBLY INSTRUCTION

A×5pcs 	B×1pc 	C×1pc 	D×1pc 
E×1pc 	F×1pc 	G×1pc 	H×1pc 

- I×  M6*25MM=4pcs
- J×  M6*20MM=4pcs
- K×  M8*45MM=4pcs
- L×  =4pcs
- M×  =1pc

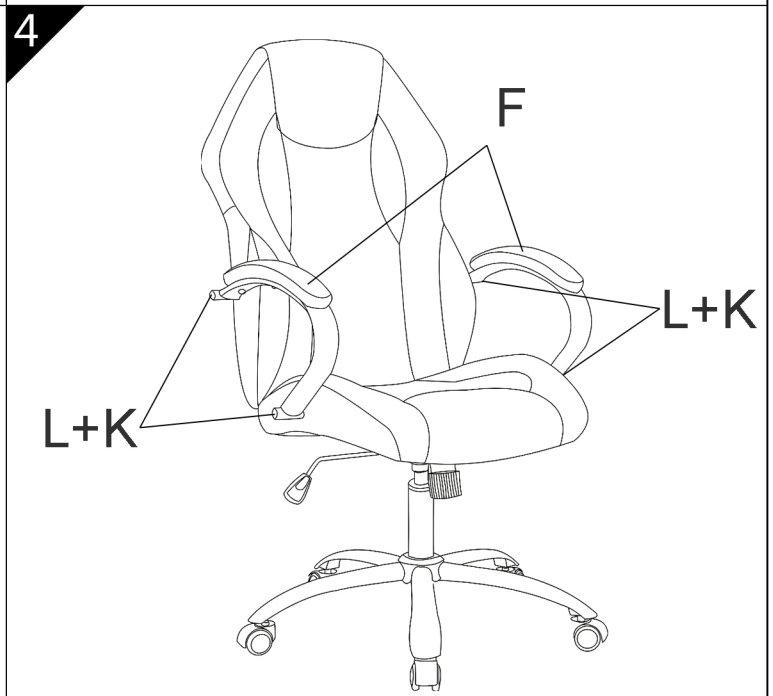
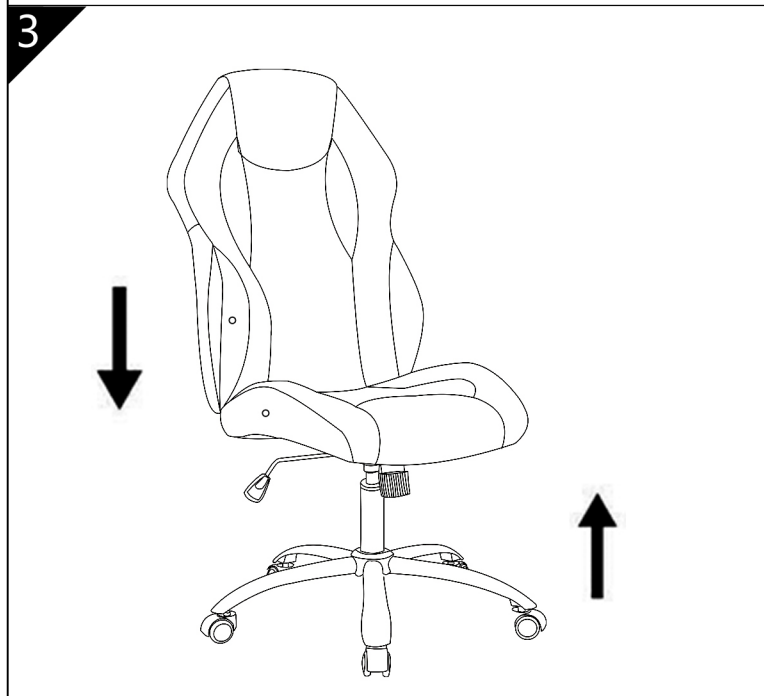
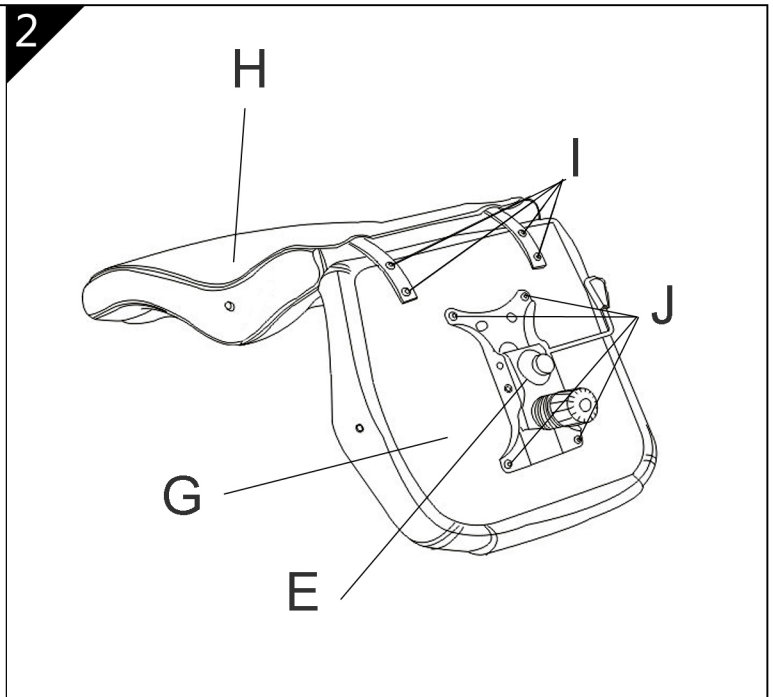
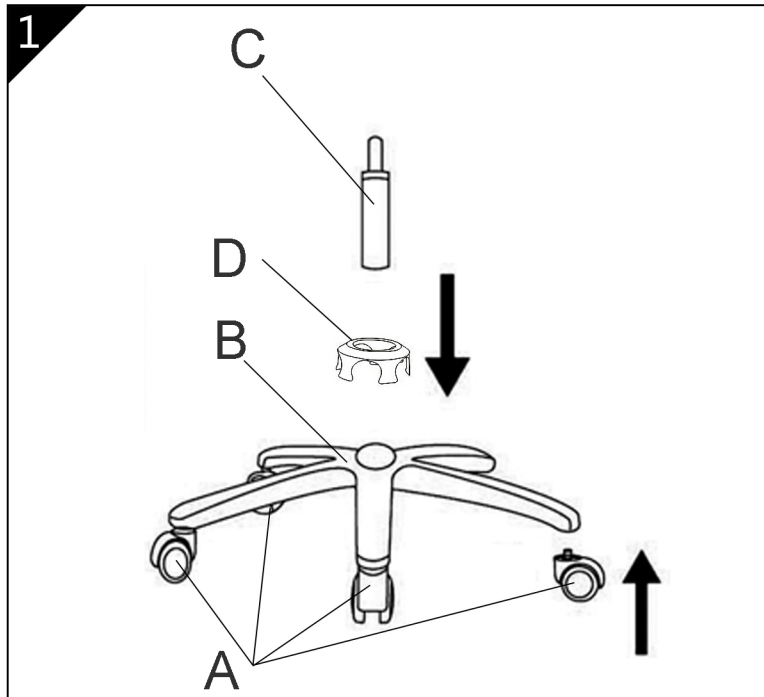

It is important to assemble all parts as the directional "ARROWS" point to. Make certain that all screws are fully tightened before using the chair, Each month check all screws and tighten those that may have loosened.
WARNING: Do not stand on the chair for any purpose