



Instruction Book
Mode d'emploi
PURE F9





www.electrolux.com



www.electrolux.com/productregistration



support.emea.electrolux.com





CONSUMABLES & ACCESSORIES

 www.electrolux.com/shop

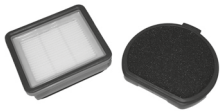
 **PUREF9 Performance Kit**
Ref: ESPK9
Part nr: 900169078/4





 **3in1 Nozzle**
Ref: ZE127
Part nr: 900922924/7



 **Home & Car kit**
Ref: KIT18
Part nr: 900922934/6





 **Citrus Burst**
Ref: ESMA
Part nr: 9001677807

 **Evening Rose**
Ref: ESRO
Part nr: 9001677765

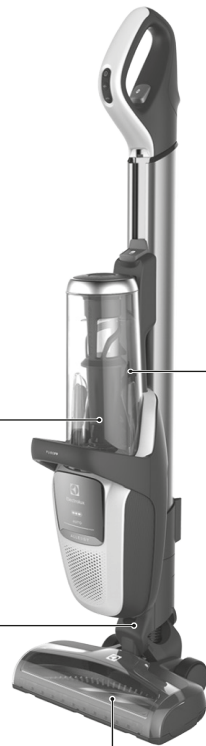

 **S-fresh 18 Value pack**
Ref: ESVP1
Part nr: 9001681221



 **Main brush roll all-floors & carpet**
Ref: ESBA9
Part nr: 9009229478

 **Long flexible crevice nozzle**
Ref: ZE121
Part nr: 9009229619



 **Micro kit**
Ref: KIT05
Part nr: 9009229601



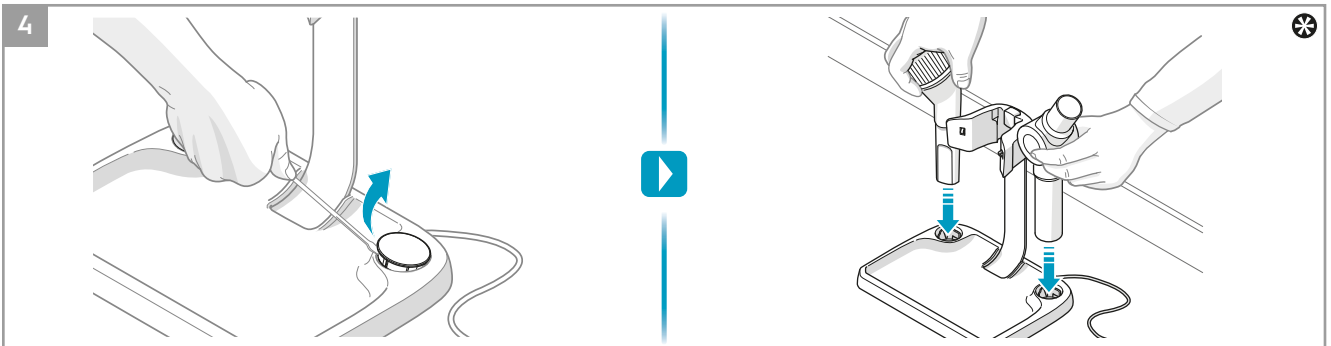
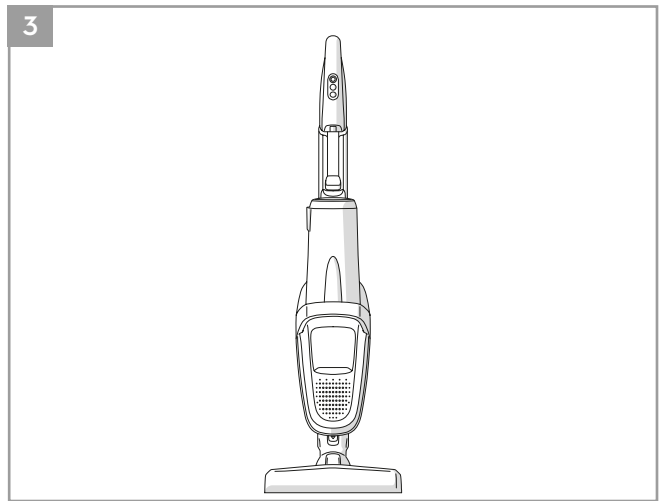
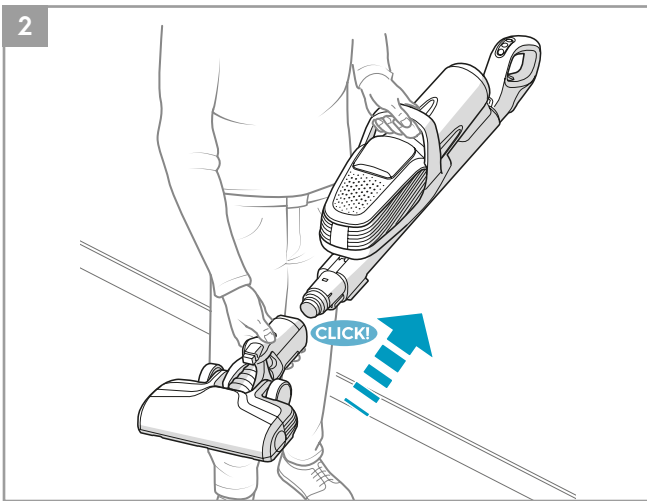
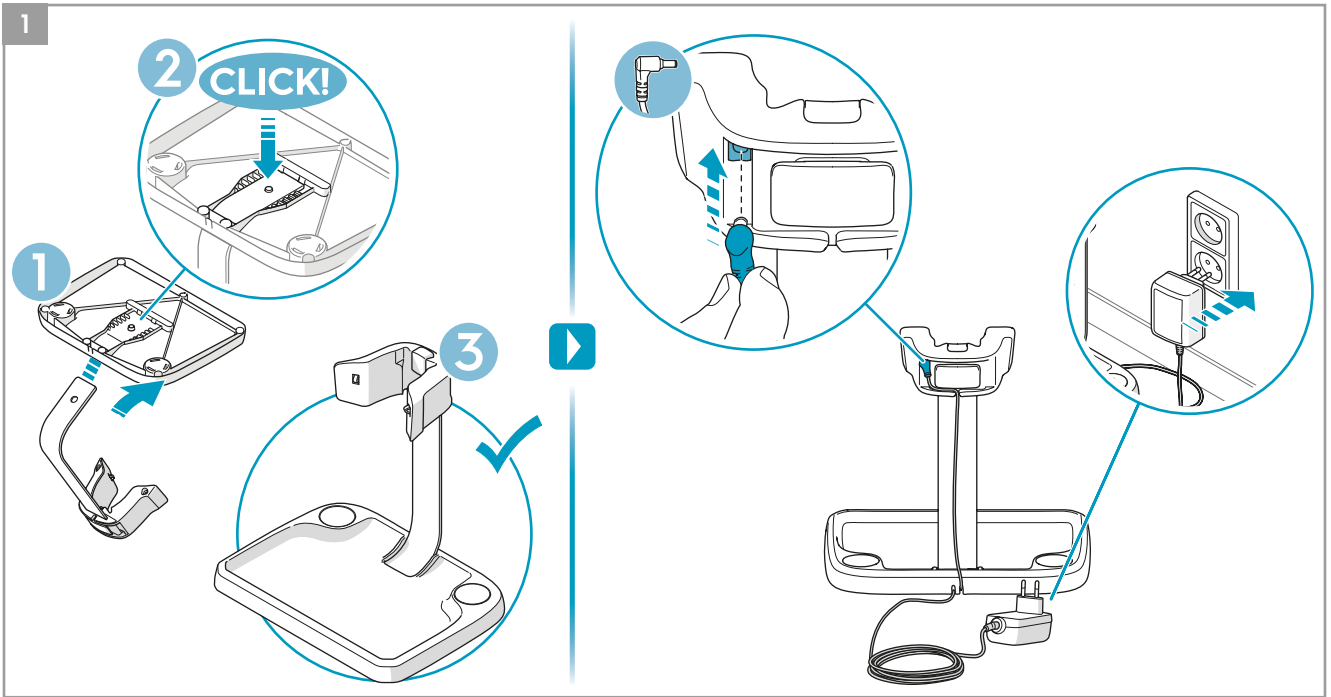
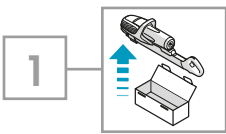

* PF91-6XXX, PF91-ANIMA, PF91-ALRGY

www.electrolux.com

2

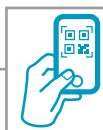
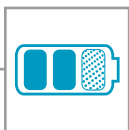

1

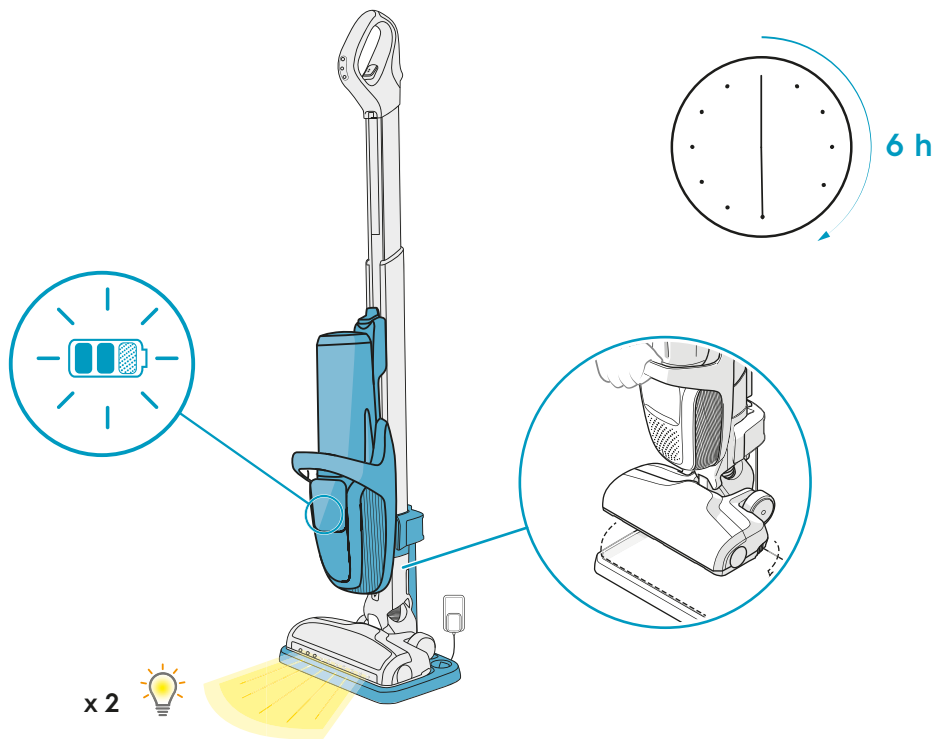

2

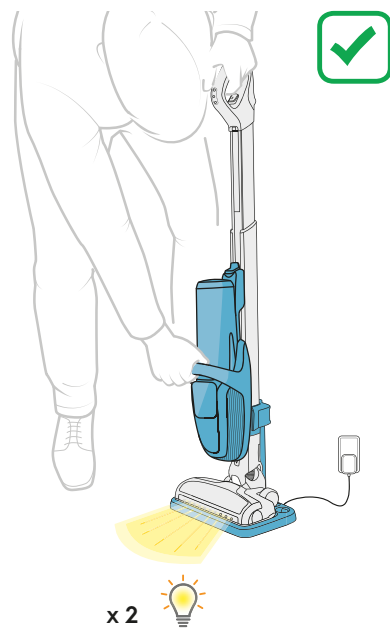
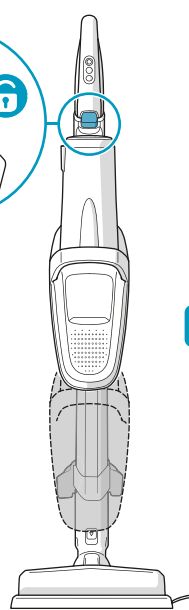
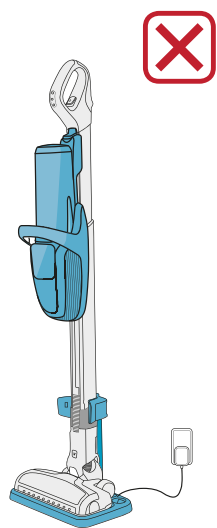

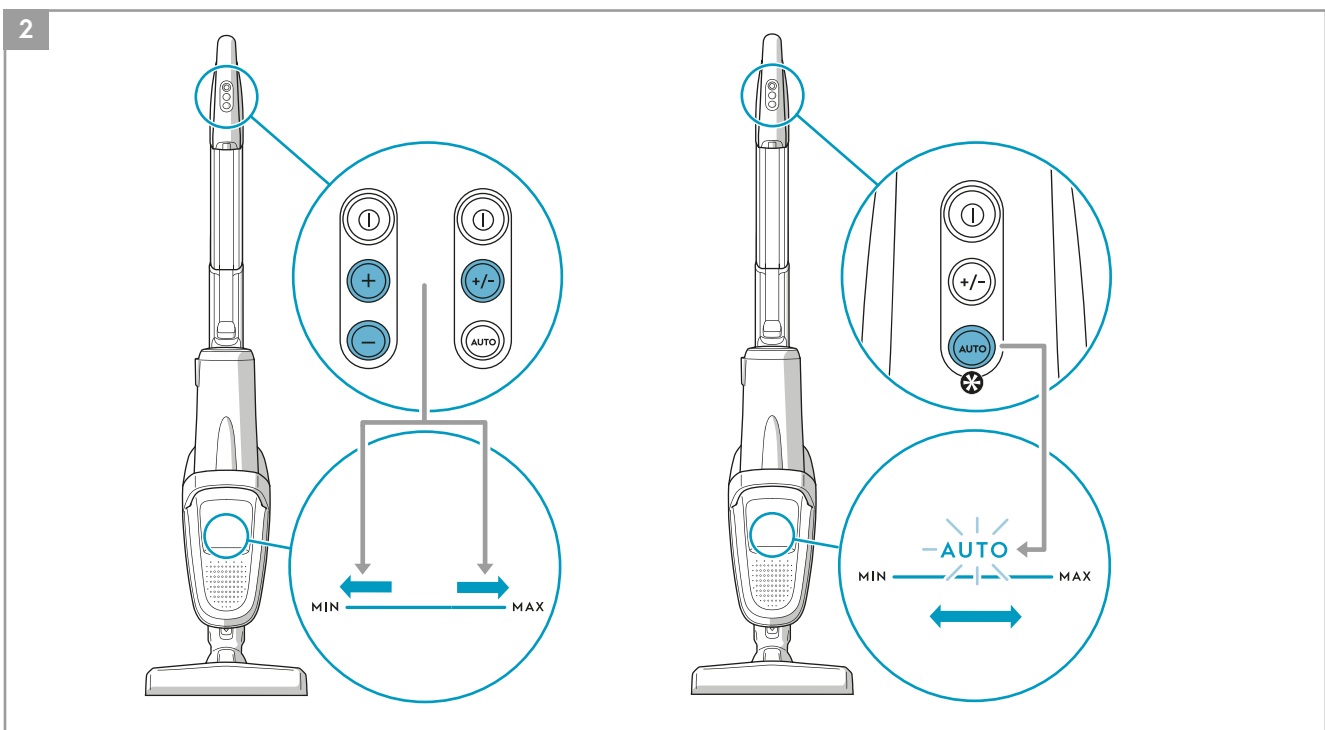
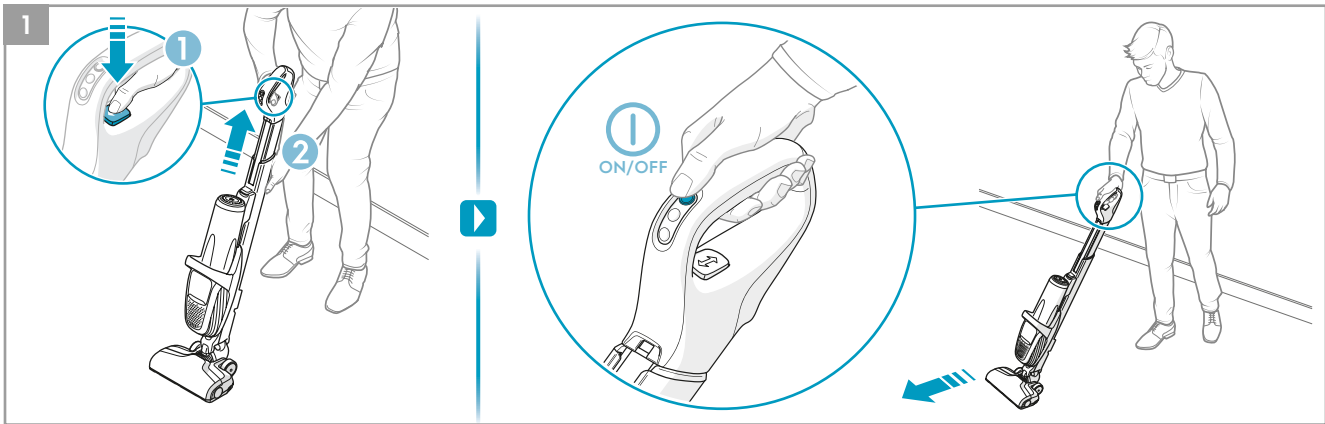
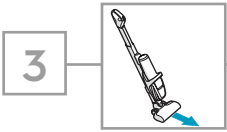

4

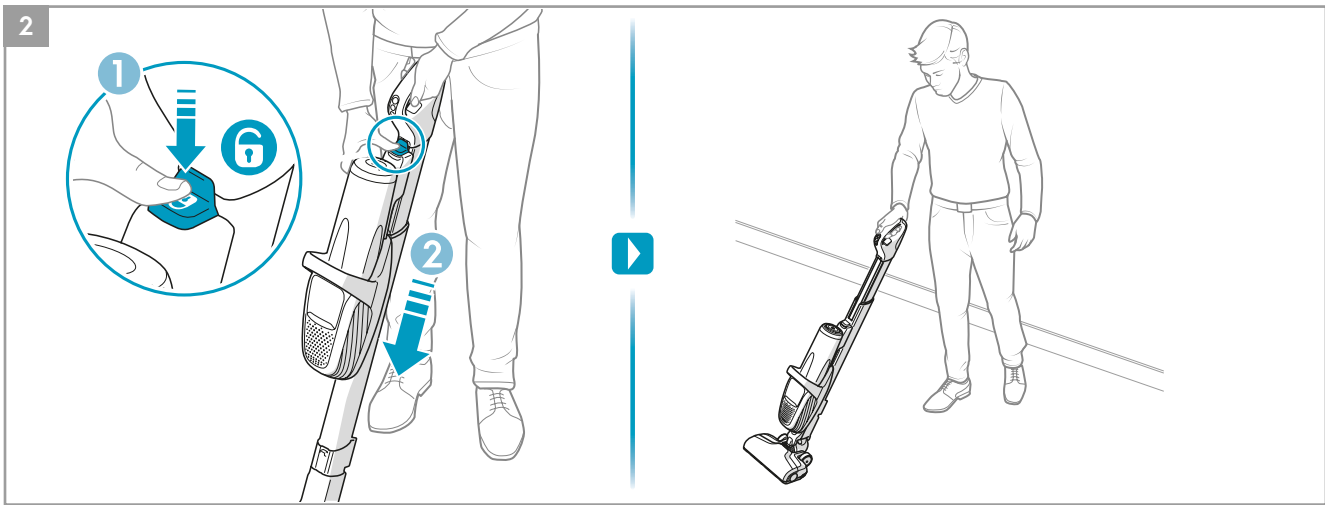
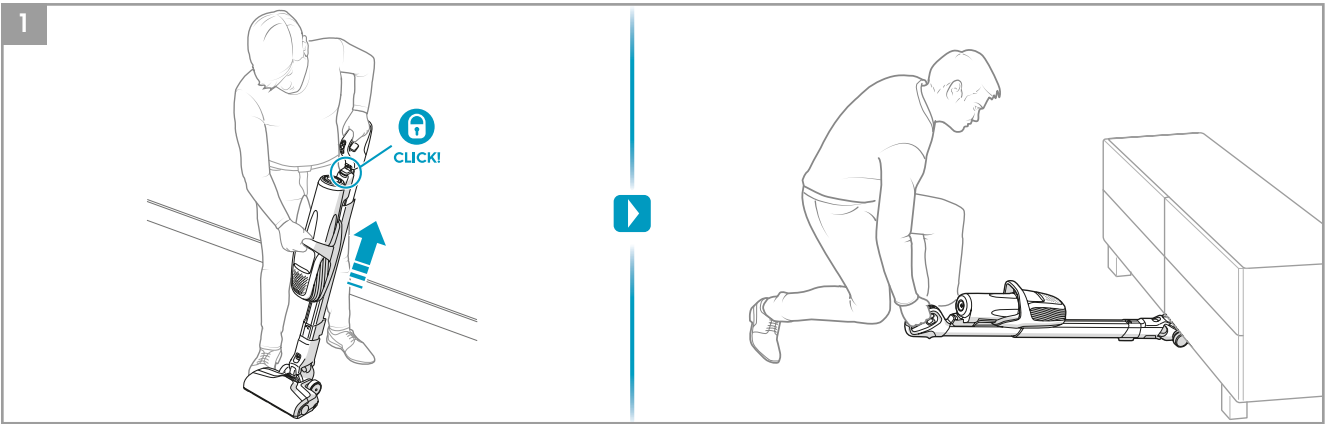

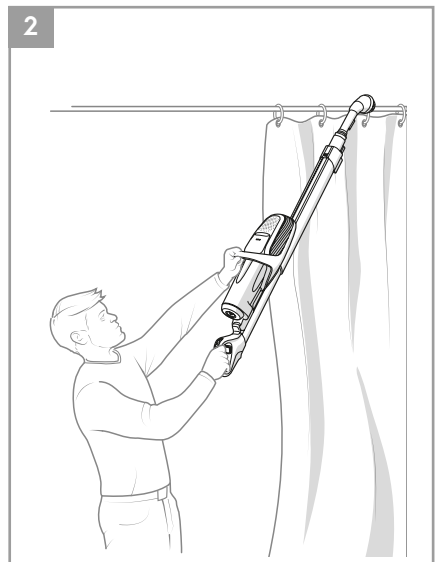
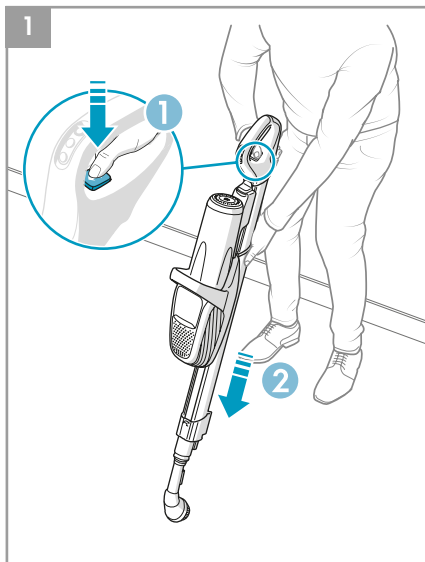
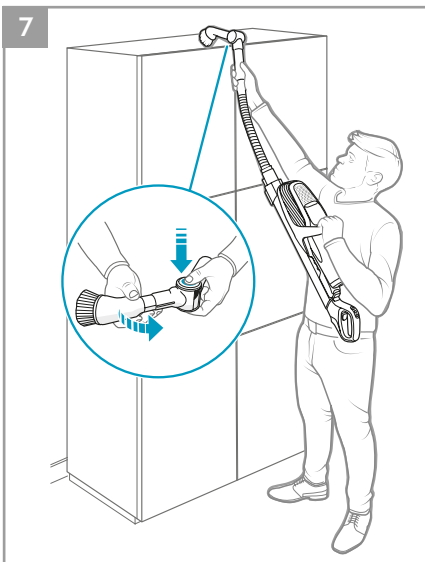
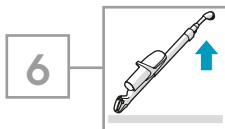
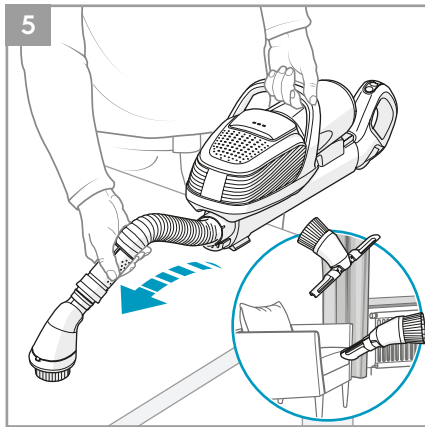
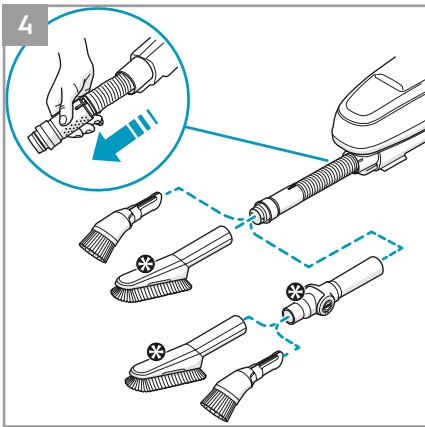
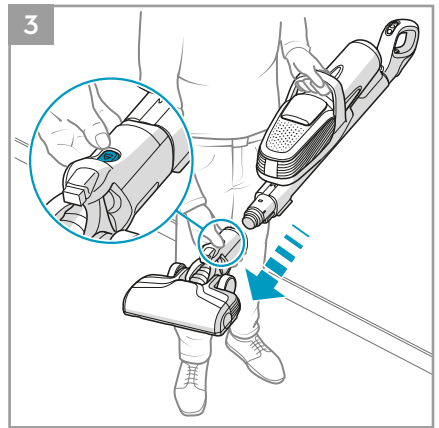
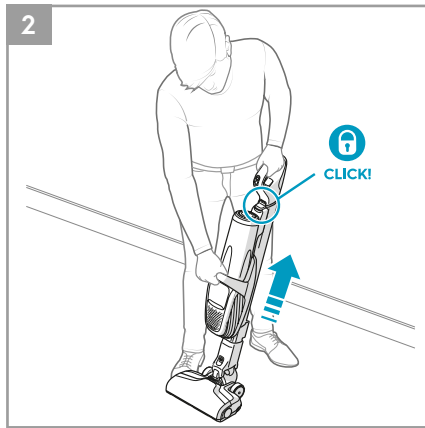
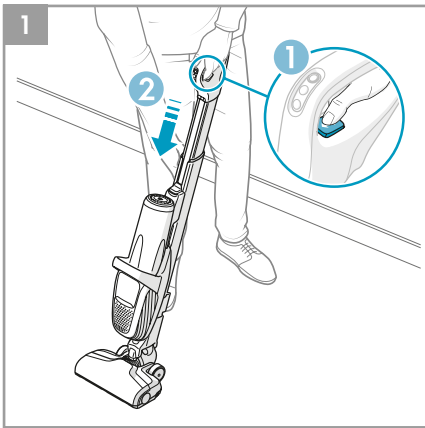
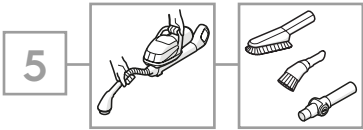

* Certain models only

